

Sprawdziany

Gauges
Lehren

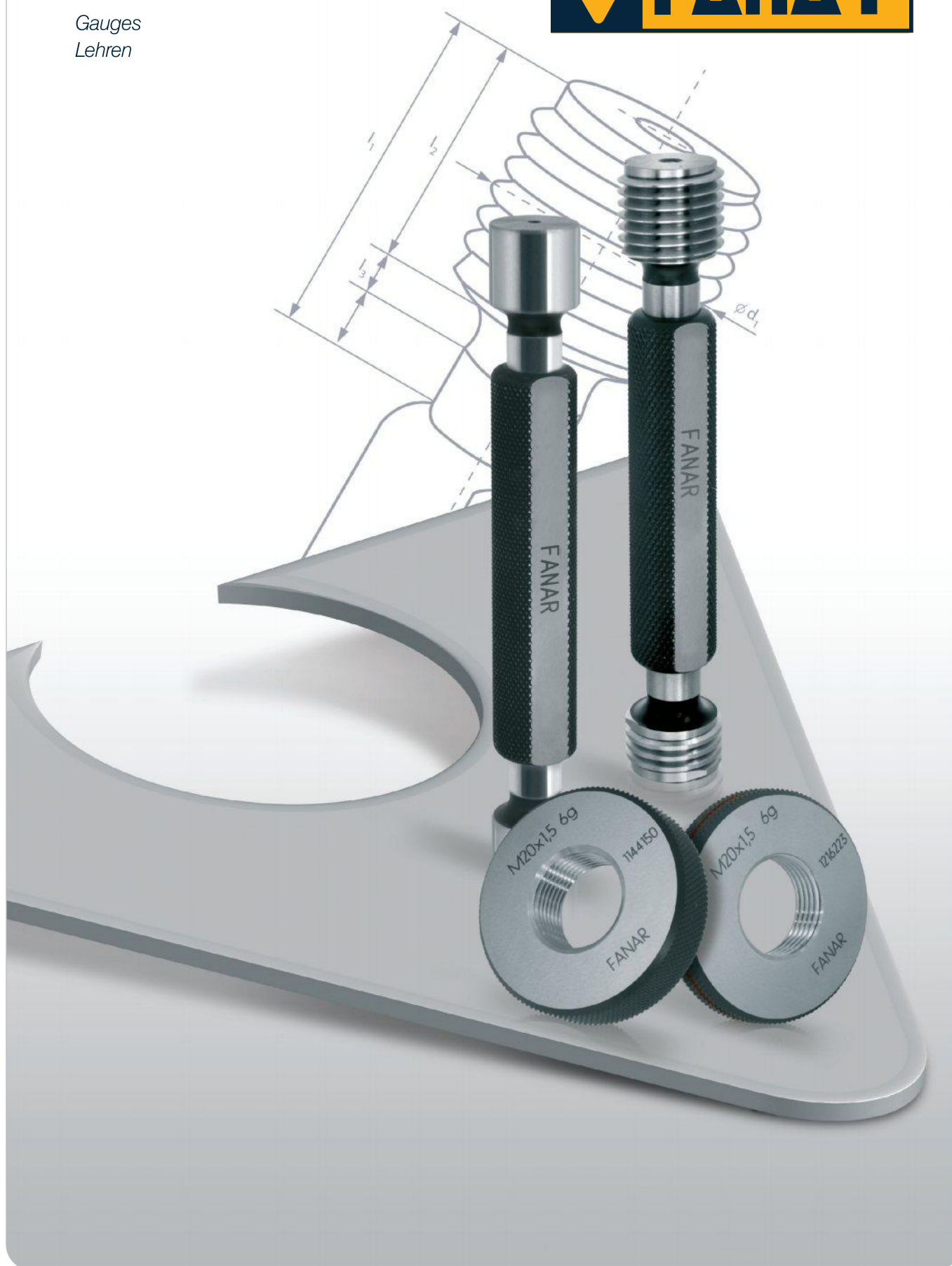

SPRAWDZIANYGAUGES
LEHRENStrona
Page
Seite**SPRAWDZIANY TŁOCZKOWE DO OTWORÓW - MSBa**SMOOTH PLUG GAUGES - MSBa
GRENZLEHRDORNE - MSBa**169****SPRAWDZIANY GWINTOWE TRZPIENIOWE I PIERŚCIENIOWE**THREAD GAUGES PLUG AND RING
GEWINDE-GRENZLEHREN DORNE UND RINGE**170-180**

M	MSBg-6H, -LH-6H, -6G	170
	MSRh-6g, MSRk-6g	
MF	MSBg-6H, LH-6H, 6G	171-172
	MSRh-6g, MSRk-6g	
UNC	MSBg-2B, -3B	173
	MSRh-2A, MSRk-2A	
UNF	MSBg-2B, -3B	174
	MSRh-2A, MSRk-2A	
G	MSBg	175
	MSRh-A, MSRk-A	
R Rc/Rp	MSXa	176
	MSXc	
BSW	MSBg	177
	MSRh, MSRk	
NPT	MSXa	178
	MSXc	
Pg	MSBg	179
	MSRh, MSRc	
Tr	MSBg-7H	180
	MSRh-7e, MSRk-7e	



Typ sprawdzianu / Type of gauge / Lehrentyp: Sp - Przechodni / Go / Gut Sn - Nieprzechodni / No go / Ausschuss					
Symbol / Symbol / Symbol		MSBa	MSBa		
Typ / Type / Typ		Sp / Sn	Sp / Sn		
Tolerancja / Tolerance / Toleranz		H7	H8		
Ø nom.	INDEX	S3-100111	S3-100112		
1	0010	●	○		
1,2	0012	●	○		
1,5	0015	●	○		
1,8	0018	●	○		
2	0020	●	○		
2,2	0022	●	○		
2,5	0025	●	○		
2,8	0028	●	○		
3	0030	●	○		
3,5	0035	○	○		
4	0040	●	○		
4,5	0045	○	○		
5	0050	●	○		
6	0060	●	○		
7	0070	○	○		
8	0080	●	○		
9	0090	○	○		
10	0100	●	○		
12	0120	●	○		
14	0140	●	○		
16	0160	●	○		
18	0180	●	○		
20	0200	●	○		
22	0220	●	○		
24	0240	●	○		
25	0250	●	○		
26	0260	○	○		
27	0270	○	○		
28	0280	●	○		
30	0300	●	○		
32	0320	●	○		
33	0330	●	○		
34	0340	●	○		
35	0350	●	○		
36	0360	●	○		
37	0370	●	○		
38	0380	●	○		
40	0400	●	○		
42	0420	●	○		
44	0440	○	○		
45	0450	●	○		
46	0460	○	○		
47	0470	●	○		
48	0480	○	○		
50	0500	●	○		
52	0520	○	○		

Powyżej Ø52 sprawdziany przechodnie mają symbol MSCb, a nieprzechodnie MSCc i wykonywane są z rękojeściami oddzielnymi

Go gauges above Ø52 are called MSCb and no go MSCc and they are produced with separate handle

Bei dem Durchmesser über Ø52 mm Gut-Lehrdorn unter Bezeichnung MSCb und Ausschuss-Lehrdorn unter Bezeichnung MSCc, mit einseitigen Handgriffen



Przykład zamawiania / Example of order / Beispiel einer Bestellung:

S3-100111-0100
MSBa 10 H7

● Dostępne z magazynu, cena w cenniku

Available from stock, the price in the price list / Ab Lager lieferbar, der Preis in der Preisliste

○ Do szybkiej dostawy, cena na zapytanie

For quick delivery, price on request / Für die schnelle Lieferung, Preis auf Anfrage

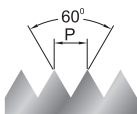
Gwint metryczny zwykły ISO DIN-13ISO Metric coarse thread DIN-13
Metrisches ISO-Regelgewinde DIN-13**Zestaw sprawdzianów**Set of gauges
Satz der Gewindelehrdörne**CZD-8 MSBg M3+M12**

Index: Z3-302161-0312

**Typ sprawdzianu / Type of gauge / Lehrentyp:****Sp - Przechodni / Go / Gut****Sn - Nieprzechodni / No go / Ausschuss**

Symbol / Symbol / Symbol			MSBg	MSBg LH	MSBg	MSRh	MSRk
Typ / Type / Typ			Sp / Sn	Sp / Sn	Sp / Sn	Sp	Sn
Tolerancja / Tolerance / Toleranz			6H	6H	6G	6g	6g
M	P	INDEX	S3-302161	S3-301161	S3-302162	Y3-412162	Y3-422162
M 1	0,25	0010	●	○	○	●	●
M 1,2	0,25	0012	●	○	○	●	●
M 1,4	0,3	0014	●	○	○	●	●
M 1,6	0,35	0016	●	○	○	●	●
M 1,7	0,35	0017	●	○	○	●	●
M 1,8	0,35	0018	●	○	○	●	●
M 2	0,4	0020	●	○	○	●	●
M 2,2	0,45	0022	●	○	○	●	●
M 2,5	0,45	0025	●	○	○	●	●
M 2,6	0,45	0026	●	○	○	●	●
M 3	0,5	0030	●	○	○	●	●
M 3,5	0,6	0035	●	○	○	●	●
M 4	0,7	0040	●	○	○	●	●
M 4,5	0,75	0045	●	○	○	●	●
M 5	0,8	0050	●	○	○	●	●
M 6	1	0060	●	○	○	●	●
M 7	1	0070	●	○	○	●	●
M 8	1,25	0080	●	○	○	●	●
M 9	1,25	0090	●	○	○	●	●
M 10	1,5	0100	●	○	○	●	●
M 12	1,75	0120	●	○	○	●	●
M 14	2	0140	●	○	○	●	●
M 16	2	0160	●	○	○	●	●
M 18	2,5	0180	●	○	○	●	●
M 20	2,5	0200	●	○	○	●	●
M 22	2,5	0220	●	○	○	●	●
M 24	3	0240	●	○	○	●	●
M 27	3	0270	●	○	○	●	●
M 30	3,5	0300	●	○	○	●	●
M 33	3,5	0330	●	○	○	●	●
M 36	4	0360	●	○	○	●	●
M 39	4	0390	●	○	○	●	●
M 42	4,5	0420	●	○	○	●	●
M 45	4,5	0450	●	○	○	●	●
M 48	5	0480	●	○	○	●	●
M 52	5	0520	●	○	○	●	●

Powyżej M52 sprawdziany przechodnie mają symbol MSCh, a nieprzechodnie MSCk i wykonywane są z rękojeściami oddzielnymi

Go gauges above M52 are called MSCh and no go MSCk and they are produced with separate handle.

Bei dem Durchmesser über $\text{Æ}52$ mm Gut-Lehrdorn unter Bezeichnung MSCh und Ausschuss-Lehrdorn unter Bezeichnung MSCk, mit einseitigen Handgriffen.

Przykład zamawiania / Example of order / Beispiel einer Bestellung:

S3-302161-0030
MSBg M3 6H

● Dostępne z magazynu, cena w cenniku

Available from stock, the price in the price list / Ab Lager lieferbar, der Preis in der Preisliste

○ Do szybkiej dostawy, cena na zapytanie

For quick delivery, price on request / Für die schnelle Lieferung, Preis auf Anfrage

Gwint metryczny drobnozwojny ISO DIN-13

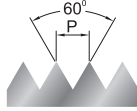
 ISO Metric fine thread DIN-13
 Metrisches ISO-Feingewinde DIN-13

Typ sprawdzianu / Type of gauge / Lehartyp:
Sp - Przechodni / Go / Gut
Sn - Nieprzechodni / No go / Ausschuss
Symbol / Symbol / Symbol
Typ / Type / Typ
Tolerancja / Tolerance / Toleranz

(LH)

MF	P	INDEX	S3-302161	S3-301161	S3-302162	Y3-412162	Y3-422162
M 3 x 0,35	0,35	0031	o	o	o	o	o
M 3,5 x 0,35	0,35	0036	o	o	o	o	o
M 4 x 0,35	0,35	0043	o	o	o	o	o
M 4x0,5	0,5	0041	o	o	o	o	o
M 4,5 x 0,5	0,5	0046	o	o	o	o	o
M 5 x 0,5	0,5	0051	o	o	o	o	o
M 6 x 0,5	0,5	0061	o	o	o	o	o
M 6 x 0,75	0,75	0062	o	o	o	o	o
M 8 x 0,5	0,5	0081	o	o	o	o	o
M 8 x 0,75	0,75	0082	o	o	o	o	o
M 8 x 1	1	0083	●	●	o	●	●
M 9 x 1	1	0093	o	o	o	o	o
M 10 x 0,75	0,75	0102	o	o	o	o	o
M 10 x 1	1	0103	●	●	o	●	●
M 10 x 1,25	1,25	0104	●	●	o	●	●
M 11 x 1	1	0113	o	o	o	o	o
M 12 x 1	1	0123	●	●	o	●	●
M 12 x 1,25	1,25	0124	●	●	o	●	●
M 12 x 1,5	1,5	0125	●	●	o	●	●
M 13 x 1	1	0133	o	o	o	o	o
M 14 x 1	1	0143	o	o	o	o	o
M 14 x 1,25	1,25	0144	o	o	o	o	o
M 14 x 1,5	1,5	0145	●	●	o	●	●
M 15 x 1	1	0153	o	o	o	o	o
M 15 x 1,5	1,5	0155	o	o	o	o	o
M 16 x 1	1	0163	●	●	o	●	●
M 16 x 1,5	1,5	0165	●	●	o	●	●
M 18 x 1	1	0183	o	o	o	o	o
M 18 x 1,5	1,5	0185	●	●	o	●	●
M 18 x 2	2	0186	o	o	o	o	o
M 20 x 1	1	0203	●	●	o	●	●
M 20 x 1,5	1,5	0205	●	●	o	●	●
M 20 x 2	2	0206	o	o	o	o	o
M 22 x 1	1	0223	o	o	o	o	o
M 22 x 1,5	1,5	0225	●	●	o	●	●
M 22 x 2	2	0226	●	●	o	●	●
M 24 x 1	1	0243	o	o	o	o	o
M 24 x 1,5	1,5	0245	●	●	o	●	●
M 24 x 2	2	0246	●	o	o	o	o
M 25 x 1,5	1,5	0255	●	o	o	o	o
M 26 x 1,5	1,5	0265	●	o	o	o	o
M 27 x 1,5	1,5	0275	●	o	o	o	o

Przykład zamawiania / Example of order / Beispiel einer Bestellung:

 S3-302162-0083
 MSBg M8x1 6G

● Dostępne z magazynu, cena w cenniku

Available from stock, the price in the price list / Ab Lager lieferbar, der Preis in der Preisliste

○ Do szybkiej dostawy, cena na zapytanie

For quick delivery, price on request / Für die schnelle Lieferung, Preis auf Anfrage

Gwint metryczny drobnozwojny ISO DIN-13

ISO Metric fine thread DIN-13
Metrisches ISO-Feingewinde DIN-13

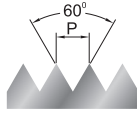

Typ sprawdzianu / Type of gauge / Lehrentyp:

Sp - Przechodni / Go / Gut

Sn - Nieprzechodni / No go / Ausschuss

Symbol / Symbol / Symbol

Typ / Type / Typ

Tolerancja / Tolerance / Toleranz



MSBg	MSBg LH	MSBg	MSRh	MSRk
Sp / Sn	Sp / Sn	Sp / Sn	Sp	Sn
6H	6H	6G	6g	6g

MF	P	INDEX	S3-302161	S3-301161	S3-302162	Y3-412162	Y3-422162
M 27 x 2	2	0276	●	○	○	○	○
M 28 x 1,5	1,5	0285	●	○	○	○	○
M 28 x 2	2	0286	○	○	○	○	○
M 30 x 1	1	0303	○	○	○	○	○
M 30 x 1,5	1,5	0305	●	○	○	○	○
M 30 x 2	2	0306	●	○	○	○	○
M 32 x 1,5	1,5	0325	●	○	○	○	○
M 33 x 1,5	1,5	0335	●	○	○	○	○
M 33 x 2	2	0336	●	○	○	○	○
M 33 x 3	3	0337	○	○	○	○	○
M 34 x 1,5	1,5	0345	○	○	○	○	○
M 35 x 1,5	1,5	0355	●	○	○	○	○
M 36 x 1,5	1,5	0365	●	○	○	○	○
M 36 x 2	2	0366	●	○	○	○	○
M 36 x 3	3	0367	○	○	○	○	○
M 38 x 1,5	1,5	0385	●	○	○	○	○
M 39 x 2	2	0396	●	○	○	○	○
M 39 x 3	3	0397	○	○	○	○	○
M 40 x 1,5	1,5	0405	●	○	○	○	○
M 40 x 2	2	0406	○	○	○	○	○
M 40 x 3	3	0407	○	○	○	○	○
M 42 x 1,5	1,5	0425	●	○	○	○	○
M 42 x 2	2	0426	●	○	○	○	○
M 42 x 3	3	0427	●	○	○	○	○
M 45 x 1,5	1,5	0455	●	○	○	○	○
M 45 x 2	2	0456	●	○	○	○	○
M 45 x 3	3	0457	○	○	○	○	○
M 48 x 1,5	1,5	0485	○	○	○	○	○
M 48 x 2	2	0486	●	○	○	○	○
M 48 x 3	3	0487	●	○	○	○	○
M 50 x 1,5	1,5	0505	○	○	○	○	○
M 50 x 2	2	0506	○	○	○	○	○
M 50 x 3	3	0507	○	○	○	○	○
M 52 x 1,5	1,5	0525	●	○	○	○	○
M 52 x 2	2	0526	●	○	○	○	○
M 52 x 3	3	0527	●	○	○	○	○

Powyżej M52 sprawdziany przechodnie mają symbol MSCh, a nieprzechodnie MSCk i wykonywane są z rękojeściami oddzielnymi

Go gauges above M52 are called MSCh and no go MSCk and they are produced with separate handle.

Bei dem Durchmesser über $\text{Æ}52$ mm Gut-Lehrdorn unter Bezeichnung MSCh und Ausschuss-Lehrdorn unter Bezeichnung MSCk, mit einseitigen Handgriffen.

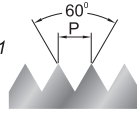

**Gwint amerykański
 zunifikowany UNC, ANSI B-1.1**

 American unified coarse thread UNC, ANSI B-1.1
 Amerikanisches Unified - Grobgewinde UNC, ANSI B-1.1

Typ sprawdzianu / Type of gauge / Lehrentyp:
Sp - Przechodni / Go / Gut
Sn - Nieprzechodni / No go / Ausschuss
Symbol / Symbol / Symbol
Typ / Type / Typ
Tolerancja / Tolerance / Toleranz

UNC	Ø d ₁	1"/P	INDEX	S3-302186	S3-302187	Y3-412182	Y3-422182
No 5 - 40	3,175	40	4105	●	○	○	○
No 6 - 32	3,505	32	4106	●	○	○	○
No 8 - 32	4,166	32	4108	●	○	○	○
No 10 - 24	4,826	24	4110	●	○	○	○
No 12 - 24	5,486	24	4112	●	○	○	○
1/4 - 20	6,350	20	4127	●	○	○	○
5/16 - 18	7,938	18	4128	●	○	○	○
3/8 - 16	9,525	16	4129	●	○	○	○
7/16 - 14	11,112	14	4130	●	○	○	○
1/2 - 13	12,700	13	4131	●	○	○	○
9/16 - 12	14,288	12	4132	●	○	○	○
5/8 - 11	15,875	11	4133	●	○	○	○
3/4 - 10	19,050	10	4135	●	○	○	○
7/8 - 9	22,225	9	4137	●	○	○	○
1 - 8	25,400	8	4139	●	○	○	○
1.1/8 - 7	28,575	7	4141	○	○	○	○
1.1/4 - 7	31,750	7	4143	○	○	○	○
1.3/8 - 6	34,925	6	4145	○	○	○	○
1.1/2 - 6	38,100	6	4147	○	○	○	○
1.3/4 - 5	44,450	5	4151	○	○	○	○
2 - 4.1/2	50,800	4.1/2	4155	○	○	○	○

Przykład zamawiania / Example of order / Beispiel einer Bestellung:

 S3-302187-4127
 MSBg 1/4-20 UNC 3B

 ● **Dostępne z magazynu, cena w cenniku**

Available from stock, the price in the price list / Ab Lager lieferbar, der Preis in der Preisliste

 ○ **Do szybkiej dostawy, cena na zapytanie**

For quick delivery, price on request / Für die schnelle Lieferung, Preis auf Anfrage

**Gwint amerykański zunifikowany
drobnozwojny UNF, ANSI B-1.1**

American unified fine thread UNF, ANSI B-1.1
Amerikanisches Unified - Feingewinde UNF, ANSI B-1.1

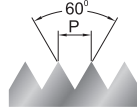

Typ sprawdzianu / Type of gauge / Lehrentyp:

Sp - Przechodni / Go / Gut

Sn - Nieprzechodni / No go / Ausschuss

Symbol / Symbol / Symbol

Typ / Type / Typ

Tolerancja / Tolerance / Toleranz



MSBg

MSBg

MSRh

MSRk

Sp / Sn

Sp / Sn

Sp

Sn

2B

3B

2A

2A

UNF	Ø d ₁	1"/P	INDEX	S3-302186	S3-302187	Y3-412182	Y3-422182
No 5 - 44	3,175	44	4205	○	○	○	○
No 6 - 40	3,505	40	4206	○	○	○	○
No 8 - 36	4,166	36	4208	○	○	○	○
No 10 - 32	4,826	32	4210	○	○	○	○
No 12 - 28	5,486	28	4212	○	○	○	○
1/4 - 28	6,350	28	4227	●	○	○	○
5/16 - 24	7,938	24	4228	●	○	○	○
3/8 - 24	9,525	24	4229	●	○	○	○
7/16 - 20	11,112	20	4230	●	○	○	○
1/2 - 20	12,700	20	4231	●	○	○	○
9/16 - 18	14,288	18	4232	●	○	○	○
5/8 - 18	15,875	18	4233	●	○	○	○
3/4 - 16	19,050	16	4235	●	○	○	○
7/8 - 14	22,225	14	4237	●	○	○	○
1 - 12	25,400	12	4239	●	○	○	○
1.1/8 - 12	28,575	12	4241	○	○	○	○
1.1/4 - 12	31,750	12	4243	○	○	○	○
1.3/8 - 12	34,925	12	4245	○	○	○	○
1.1/2 - 12	38,100	12	4247	○	○	○	○

Przykład zamawiania / Example of order / Beispiel einer Bestellung:

Y3-422182-4235
MSRk 3/4-16 UNF 2A

● Dostępne z magazynu, cena w cenniku

Available from stock, the price in the price list / Ab Lager lieferbar, der Preis in der Preisliste

○ Do szybkiej dostawy, cena na zapytanie

For quick delivery, price on request / Für die schnelle Lieferung, Preis auf Anfrage

Gwint rurowy walcowy G, DIN-ISO 228

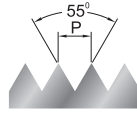
 Whitworth pipe thread G, DIN-ISO 228
 Whitworth Rohrgewinde G, DIN-ISO 228

Typ sprawdzianu / Type of gauge / Lehrentyp:
Sp - Przechodni / Go / Gut
Sn - Nieprzechodni / No go / Ausschuss
Symbol / Symbol / Symbol
Typ / Type / Typ
Tolerancja / Tolerance / Toleranz

MSBg

MSRh

MSRk

Sp / Sn

Sp

Sn

A

A

G	Ø d ₁	1"/P	INDEX	S3-302180	Y3-412180	Y3-422180
G-1/8"	9,73	28	3123	●	○	○
G-1/4"	13,16	19	3127	●	○	○
G-3/8"	16,66	19	3129	●	●	●
G-1/2"	20,96	14	3131	●	●	●
G-5/8"	22,91	14	3133	○	○	○
G-3/4"	26,44	14	3135	●	●	●
G-7/8"	30,20	14	3137	○	○	○
G-1"	33,25	11	3139	●	●	●
G-1.1/8"	37,90	11	3141	●	○	○
G-1.1/4"	41,91	11	3143	●	○	○

Przykład zamawiania / Example of order / Beispiel einer Bestellung:

 S3-302180-3127
 MSBg G-1/4"

 ● **Dostępne z magazynu, cena w cenniku**
Available from stock, the price in the price list / Ab Lager lieferbar, der Preis in der Preisliste

 ○ **Do szybkiej dostawy, cena na zapytanie**
For quick delivery, price on request / Für die schnelle Lieferung, Preis auf Anfrage

Gwint rurowy do połączeń ze szczelnością uzyskiwaną na gwincie

Pipe thread without dry seal material
Rohrgewinde für im Gewinde dichtende Verbindungen

**PN-EN 10226-1,
PN-EN 10226-2 (ISO7-1:2000)**

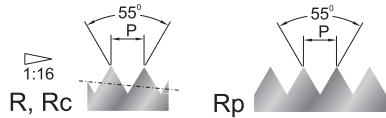

Typ sprawdzianu / Type of gauge / Lehrentyp:

Patrz strona 236
See page 266
Siehe Seite 296

PN-EN 10226-3 (ISO7-2:2000)



Symbol / Symbol / Symbol

MSXa MSXa MSXc MSXc MSXa MSXc

Typ / Type / Typ

Nr 1 Nr 2 Nr 3 Nr 4 Nr 5 Nr 6

Do gwintu / For thread / Für gewinde

Rc/Rp Rc/Rp R R R Rc

Rc	Ø d ₁	1"/P	INDEX	S3-332101	S3-332102	-	-	S3-332105	-
1/16"	7,72	28	3321	o	o			o	
1/8"	9,73	28	3323	o	o			o	
1/4"	13,16	19	3327	o	o			o	
3/8"	16,66	19	3329	o	o			o	
1/2"	20,96	14	3331	o	o			o	
3/4"	26,44	14	3335	o	o			o	
1"	32,25	11	3339	o	o			o	
1.1/4"	41,91	11	3343	o	o			o	
1.1/2"	47,80	11	3347	o	o			o	
2"	59,61	11	3355	o	o			o	
2.1/2"	75,18	11	3359	o	o			o	
3"	87,88	11	3363	o	o			o	
4"	113,03	11	3371	o	o			o	

R	Ø d ₁	1"/P	INDEX	-	-	Y3-432103	Y3-432104	-	Y3-432106
1/16"	7,72	28	3421			o	o		o
1/8"	9,73	28	3423			o	o		o
1/4"	13,16	19	3427			o	o		o
3/8"	16,66	19	3429			o	o		o
1/2"	20,96	14	3431			o	o		o
3/4"	26,44	14	3435			o	o		o
1"	32,25	11	3439			o	o		o
1.1/4"	41,91	11	3443			o	o		o
1.1/2"	47,80	11	3447			o	o		o
2"	59,61	11	3455			o	o		o
2.1/2"	75,18	11	3459			o	o		o
3"	87,88	11	3463			o	o		o
4"	113,03	11	3471			o	o		o

Informacje techniczne odnośnie konstrukcji oraz stosowania sprawdzianów R i Rc/Rp w części technicznej katalogu na stronie 266

Technical information concerning construction and use of gauges R and Rc / Rp in the technical part of the catalogue on page 266

Technische Informationen über den Konstruktion und die Verwendung von Lehren für R-, Rc- und Rp- Rohrgewinde – s. technischer Teil unseres Katalogs auf Seite 326

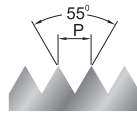

**Gwint calowy zwykły
Whitwortha BSW, BS-84:1956**

 Whitworth thread BSW, BS-84:1956
 Whitworth-Gewinde BSW, BS-84:1956

Typ sprawdzianu / Type of gauge / Lehrentyp:
Sp - Przechodni / Go / Gut
Sn - Nieprzechodni / No go / Ausschuss
Symbol / Symbol / Symbol
Typ / Type / Typ
Tolerancja / Tolerance / Toleranz

MSBg

MSRh

MSRk

Sp / Sn

Sp

Sn

medium

medium

medium

BSW	Ø d ₁	1"/P	INDEX	S3-302100	Y3-412100	Y3-422100
1/8 - 40	3,175	40	7123	○	○	○
3/16 - 24	4,762	24	7125	○	○	○
1/4 - 20	6,350	20	7127	○	○	○
5/16 - 18	7,938	18	7128	○	○	○
3/8 - 16	9,525	16	7129	○	○	○
7/16 - 14	11,112	14	7130	○	○	○
1/2 - 12	12,700	12	7131	○	○	○
9/16 - 12	14,288	12	7132	○	○	○
5/8 - 11	15,875	11	7133	○	○	○
3/4 - 10	19,050	10	7135	○	○	○
7/8 - 9	22,225	9	7137	○	○	○
1 - 8	25,400	8	7139	○	○	○
1.1/8 - 7	28,575	7	7141	○	○	○
1.1/4 - 7	31,750	7	7143	○	○	○
1.3/8 - 6	34,925	6	7145	○	○	○
1.1/2 - 6	38,100	6	7147	○	○	○
1.3/4 - 5	44,450	5	7151	○	○	○
2 - 4.1/2	50,800	4.1/2	7155	○	○	○

Przykład zamawiania / Example of order / Beispiel einer Bestellung:

 Y3-412100-7131
 MSRh 1/2-12 BSW

 ● **Dostępne z magazynu, cena w cenniku**

Available from stock, the price in the price list / Ab Lager lieferbar, der Preis in der Preisliste

 ○ **Do szybkiej dostawy, cena na zapytanie**

For quick delivery, price on request / Für die schnelle Lieferung, Preis auf Anfrage

**Gwint amerykański rurowy stożkowy
NPT 1:16, ANSI B-1.20.1**

American tapered pipe thread
NPT 1:16, ANSI B-1.20.1
Amerikanisches kegeliges Rohrgewinde
NPT 1:16, ANSI B-1.20.1

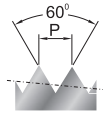

Symbol / Symbol / Symbol

MSXa

MSXc

Typ / Type / Typ

Tolerancja / Tolerance / Toleranz

NPT Ø d ₁	1"/P	INDEX	S3-332100	Y3-432100
1/16"	27	4621	○	○
1/8"	27	4623	○	○
1/4"	18	4627	○	○
3/8"	18	4629	●	○
1/2"	14	4631	●	○
3/4"	14	4635	●	○
1"	11.1/2	4639	●	○
1.1/4"	11.1/2	4643	○	○
1.1/2"	11.1/2	4647	○	○
2"	11.1/2	4655	○	○

Informacje techniczne odnośnie stosowania sprawdzianów NPT w części technicznej katalogu na stronie 265

Technical information concerning use of gauges NPT in the technical part of the catalogue on page 295

Technische Informationen über die Verwendung von Lehren für NPT Rohrgewinde – s. technischer Teil unseres Katalogs auf Seite 325

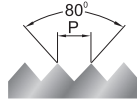
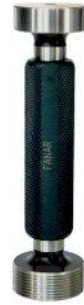

**Gwint do rurek instalacyjnych
 stalowych Pg, DIN-40430**

 Steel conduit thread Pg, DIN-40430
 Stahlpanzerrohr - Gewinde Pg, DIN-40430

Typ sprawdzianu / Type of gauge / Lehrentyp:
Sp - Przechodni / Go / Gut
Sn - Nieprzechodni / No go / Ausschuss

Symbol / Symbol / Symbol

MSBg

MSRh

MSRc

Typ / Type / Typ

Sp / Sn

Sp

Sn

Tolerancja / Tolerance / Toleranz

Pg	Ø d ₁	1"/P	INDEX	S3-832100	Y3-412100	Y3-450100
Pg 7	12,5	20	8807	o	o	o
Pg 9	15,2	18	8809	o	o	o
Pg 11	18,6	18	8811	o	o	o
Pg 13,5	20,4	18	8813	o	o	o
Pg 16	22,5	18	8816	o	o	o
Pg 21	28,3	16	8821	o	o	o
Pg 29	37	16	8829	o	o	o
Pg 36	47	16	8836	o	o	o

Gwint Pg jest zastępowany gwintem metrycznym drobnozwojnym MF wg normy DIN EN 60423 dostępnym na zapytanie

Pg thread is replaced by metric fine MF according to DIN EN 60423 available on request

Pg-Gewinde wird durch metrisches Feingewinde ersetzt nach Norm DIN EN 60423 auf Anfrage

Przykład zamawiania / Example of order / Beispiel einer Bestellung:

 S3-832100-8807
 MSBg Pg7

 ● **Dostępne z magazynu, cena w cenniku**

Available from stock, the price in the price list / Ab Lager lieferbar, der Preis in der Preisliste

 ○ **Do szybkiej dostawy, cena na zapytanie**

For quick delivery, price on request / Für die schnelle Lieferung, Preis auf Anfrage

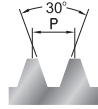
Gwint trapezowy Tr, DIN-103
 Trapezoidal thread Tr, DIN-103
 Trapezgewinde Tr, DIN-103

Typ sprawdzianu / Type of gauge / Lehrentyp:
Sp - Przechodni / Go / Gut
Sn - Nieprzechodni / No go / Ausschuss
Symbol / Symbol / Symbol

MSBg

MSRh

MSRk

Typ / Type / Typ

Sp / Sn

Sp

Sn

Tolerancja / Tolerance / Toleranz

7H

7e

7e

Tr Ø d ₁ [mm]	P [mm]	INDEX	S3-302171	Y3-412174	Y3-422174
Tr 10 x 2	2	8009	○	○	○
Tr 12 x 3	3	8015	○	○	○
Tr 14 x 3	3	8019	○	○	○
Tr 16 x 4	4	8024	○	○	○
Tr 18 x 4	4	8032	○	○	○
Tr 20 x 4	4	8034	○	○	○
Tr 22 x 5	5	8037	○	○	○
Tr 24 x 5	5	8042	○	○	○
Tr 26 x 5	5	8047	○	○	○
Tr 28 x 5	5	8052	○	○	○
Tr 30 x 6	6	8057	○	○	○
Tr 32 x 6	6	8062	○	○	○
Tr 36 x 6	6	8072	○	○	○

Przykład zamawiania / Example of order / Beispiel einer Bestellung:

 S3-302171-8009
 MSBg Tr 10x2 7H

● Dostępne z magazynu, cena w cenniku

Available from stock, the price in the price list / Ab Lager lieferbar, der Preis in der Preisliste

○ Do szybkiej dostawy, cena na zapytanie

For quick delivery, price on request / Für die schnelle Lieferung, Preis auf Anfrage