

Инструмент для резьбы

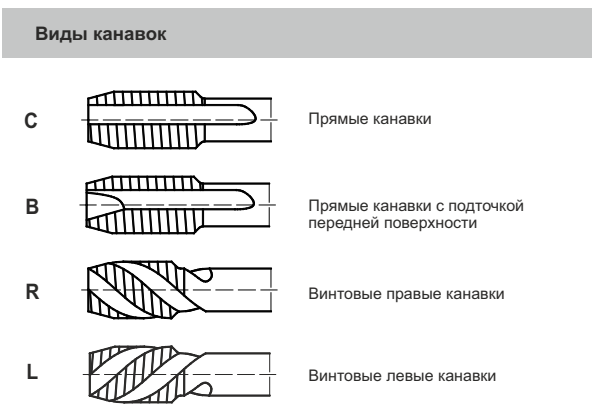



Смазочно-охлаждающие жидкости	Виды покрытий	Режущая скорость Vc (m/min)		
E Эмульсия	HL TiAlN + WC/C	TC TiN + TiCN	TB TiB ₂	10-15 Рекомендованный тип инструмента
O Масло				10-15 Применение возможно
P Паста для нарезания резьбы	TN2 TiAlN + TiN	AT AlTiN		Ручная обработка

Величина скорости резания указана ориентировочно. Оптимальные скорости подбираются экспериментально.

Пример материала	№ материала	Тип (длина) стружки	Группа материалов
11SMnPb30, 10SPb20, 35S20, 11SMn37	1.0718, 1.0722, 1.0726, 1.0736	Короткая P1	P
S235JR, S275JR, C22, C45	1.0038, 1.0044, 1.0402, 1.0503	Длинная P2	
C55, C60, C60E	1.0535, 1.0601, 1.1221	Длинная P3	
C25E, C53G, G18Mo5, 16Mo5	1.1158, 1.1213, 1.5422, 1.5423	Длинная P4	
C55, C55E, C60E	1.0535, 1.1203, 1.1221	Длинная P5	
36Mn5, 107CrV3, 100Cr6, 20NiCrMo2-2, 41Cr4	1.1167, 1.2210, 1.3505, 1.6523, 1.7035	Длинная P6	
34Cr4, 25CrMo4, Weldox 700, Weldox 900	1.7033, 1.7218	Длинная P7	
36NiCr6, 34CrNiMo6, 55Cr3, 51CrV4	1.5710, 1.6582, 1.7176, 1.8159	Длинная P8	
55Si7, 60SiCr7, 55NiCrMoV6, 40CrMoV13-9	1.0904, 1.0961, 1.2713, 1.8523	Длинная P9	
X210Cr12, X100CrMoV5-1, HS6-5-2-5, HS6-5-2	1.2080, 1.2363, 1.3243, 1.3343	Средняя P10	
HS6-5-2-5, HS18-1-2-5, HS 10-2-5-8, HS 6-5-3-8	1.3243, 1.3255, 1.3253, 1.3294	Средняя P11	
X30WCrV9-3	1.2581	Средняя P12	
X6Cr13, X12Cr13, X14CrMoS17, X6CrMo17-1	1.4000, 1.4006, 1.4104, 1.4113	Длинная P13	
X12Cr13, GX20Cr14, X19CrNi17-2, X45CrSi9-3-1	1.4006, 1.4027, 1.4057, 1.4718	Длинная P14	
X5CrNi18-10, X5CrNiMo17-12-2, X2CrNiMo18-14-3, X12NiCrSi36-16	1.4301, 1.4401, 1.4435, 1.4864	Длинная M1	M
X9CrNi18-8, X53CrMnNiN21-9	1.4310, 1.4871	Длинная M2	
X2CrNiN23-4, X2CrNiMoN17-13-3, X2CrNiMoN22-5-3, X2CrNiMoCuN25-6-3	1.4362, 1.4429, 1.4462, 1.4507	Длинная M3	
EN-GJL-100, EN-GJL-200, EN-GJL-300, EN-GJL-400	0.6010, 0.6020, 0.6030, 0.6040	Очень короткая K1	K
EN-GJV-300, EN-GJV-400, EN-GJV-500, EN-GJV-550	-	Короткая/Средняя K2	
EN-GJMW-300-26, EN-GJMB-350-10, EN-GJMB-450-6	0.8035, 0.8135, 0.8145	Короткая/Средняя K3	
EN-GJMB-550-4, EN-GJMB-700-2, EN-GJMB-800-1	0.8155, 0.8170, 0.8180	short/Средняя K4	
EN-GJS-400-15, EN-GJS-500-7, EN-GJS-700-2	0.7040, 0.7050, 0.7070	short/Средняя K5	
EN-GJS-800-8, EN-GJS-1200-2, EN-GJS-1400-1	-	short/Средняя K6	
ENAW-AI99.5, ENAW-AISi1MgMn (PA4), ENAW-AIMg0.7Si (PA38), ENAW-AIMg3 (PA11)	3.0255, 3.2315, 3.3206, 3.3535	Длинная N1	N
ENAW-AICu6BiPb, ENAW-AICu4MgSi(A) (PA6), ENAW-AIZn5.5MgCu (PA9) ENAW-AIMg4.5Mn0.7 (PA13)	3.1655, 3.1325, 3.4365, 3.3547	Длинная N2	
ENAC-AISi12, ENAC-AISi12(Fe), ENAC-AISi12(Cu), ENAC-AIMg5	3.2581, 3.2582, 3.2583, 3.3561	Короткая/Средняя N3	
ENAC-AICu4MgTi, ENAC-AISi7Mg0.3, ENAC-AISi9Mg, ENAC-AISi10Mg(a)	3.1371, 3.2371, 3.2373, 3.2381	Короткая/Средняя N4	
ENAC-AISi17Cu4Mg	-	Короткая N5	
EN-MAMgMn1, EN-MCMgRE3Zn2Zr, EN-MCMgRE2Ag2Zr, EN-MCMgAl4Si	3.5101, 3.5103, 3.3506, 3.5470	Короткая N6	
Cu-OF, Cu-DHP, CuZn35Mn2Al1Fe1-C, CuAl10Ni5Fe4	2.0040, 2.0090, 2.0592, 2.0966	Очень длинная N7	
CuZn37 (M63), CuAl10Ni5Fe4, CuSn8P	2.0321, 2.0966, 2.1030	Длинная N8	
CuZn40Pb2 (M58)(MO58), CuSn7Zn4Pb7-C, CuSn5Zn5Pb5-C, CuSn10Pb10-C	2.0402, 2.1090, 2.1096, 2.1176	Короткая N9	
AMPCO 8, AMPCO 21, AMPCO M4	-	Длинная N10	
Incoloy 909, Multimet 155, X10NiCrAlTi3220 (Incoloy 800), X40CoCrNi2020	1.4876, 1.4977	Длинная S1	S
Incoloy A-286, Unitemp 212	-	Длинная S2	
Incoloy 864, Nimocast 713	-	Длинная S3	
Inconel 718, Nimonic 80A	-	Длинная S4	
GMR 235*, Jessop G81*	-	Длинная S5	
Ti 99.8, TiCu2	3.7025, 3.7124	Очень длинная S6	
Ti-6Al-4V, Ti-6Al-2Mo-2Cr, Ti-6Al-6Mo-4Zr-2Sn	3.7165	Короткая/Средняя S7	
Ti-10V-2Fe-3Al, Ti-13V-11Cr-3Al	-	Короткая/Средняя S8	
Weldox 1100, Weldox 1300, Hardox 500	-	Короткая H1	H
Hardox 550, Hardox 600, Armax 600 T	-	Короткая H2	
Hardox Extreme	-	Короткая H3	
GX260NiCr42, GX330NiCr42, GX300CrMoNi15-2-1	0.9620, 0.9625, 0.9640	Короткая H4	

Инструментальный завод FANAR S.A. является одним из ведущих производителей режущего инструмента.

На протяжении многих лет, мы ориентируемся на инновации, качество и непрерывное развитие. Наши знания и опыт в совокупности с новейшими технологиями и современным парком оборудования позволяют нам предлагать нашим партнерам инновационные продукты, отвечающие самым высоким требованиям качества. Мы являемся надежным поставщиком инструмента на международном уровне. Мы сотрудничаем с крупнейшими

мировыми производителями автомобильной, аэрокосмической, медицинской, бытовой техники, а также в других отраслях промышленности. Широкий ассортимент продукции, качественный сервис, высокая квалификация наших специалистов и современный уровень IT решений позволяют максимально удовлетворять потребности наших партнеров.



Мы являемся производителями глобального уровня

Сегодня наш инструмент представлен более чем в 40 странах на всех континентах. Наш бренд становится все более узнаваем как бренд производителя инструмента высокого качества, что способствует дальнейшему расширению географии продаж. При поиске резьбообрабатывающего инструмента наивысшего качества воспользуйтесь нашей глобальной дилерской сетью. Текущий список официальных дилеров представлен на нашем сайте: www.fanar.pl

Группы применения высокопроизводительных инструментов и их назначение

MASTERTAP	Группа машинных метчиков предназначенных для высокопроизводительного нарезания резьбы в широком спектре материалов, таких как сталь, нержавеющая сталь, чугун, цветные металлы, жаропрочные сплавы и титановые сплавы. Нарезание резьбы может выполняться на современных высокоэффективных обрабатывающих центрах с высокими скоростями резания, на старших типах станков с ЧПУ и на обычных машинах с более низкими параметрами обработки.	GG	Для серого и сфероидального чугуна
800X	Группа 800X имеет улучшенные характеристики группы 800. - Значительно повышена производительность и стойкость. - Шире спектр использования: позволяет дополнительно обрабатывать нержавеющую сталь,	GAL	Для алюминиевых сплавов с содержанием Si max. 12%
800	Для конструкционных, углеродистых, автоматных, низколегированных сталей 600MPa \pm Rm \pm 800 MPa	HRC	Для твердых сталей. Цифровой индекс соответствует твердости обрабатываемого материала по шкале HRC
FAN-200	Для инструментальных, труднообрабатываемых сталей 800 MPa \pm Rm \pm 1200 MPa и для сталей с твердостью до 38 HRC	S-NC	Для синхронного нарезания резьбы на станках с ЧПУ с функцией "soft-synchr" для широкго спектра материалов
1400	Для труднообрабатываемых, кислотостойких сталей 1000 MPa \pm Rm \pm 1400 MPa и для сталей с твердостью до 44 HRC	Ms	Для латуни и короткостружечной бронзы
INOX	Для высоколегированных, нержавеющих, кислотостойких сталей Rm \pm 1000 MPa	WGN	Метчики-раскатники для обработки материалов с показателем пластичности A5I10%

Типы резьбовых отверстий

отметка



Повсеместно

● Доступно со склада































Слепой

○ По запросу





























Отжиг	A		
Улучшаемая температурой	QT		
Закалённая мартенситная сталь	HT		
Дисперсионное твердение	PH		

Обрабатываемые материалы

			Rm	HB	HRC		
Сталь							
P	P1	Автоматные	A	750	220		
	P2		A	650	190	-	
	P3		A	650	190	-	
	P4		QT	700	210	-	
	P5		QT	1000	300	32	
	P6	Низколегированные стали	A	600	175	-	
	P7		QT	1000	300	32	
	P8		QT	1200	380	41	
	P9		QT	1400	420	45	
	P10	Высоколегированные стали	A	700	210	-	
	P11		A	1000	300	32	
	P12		HT	1400	420	45	
	P13		Ферритные/мартенситные	A	700	210	-
	P14	Мартенситная		QT	1100	330	34
Нержавеющая сталь							
M	M1	Аустенитные		700	210	-	
	M2		PH	1000	300	32	
	M3			800	240	23	
Чугун							
K	K1	Чугун серый(GJL)		400	120	-	
	K2	Чугун с вермикулярным графитом (GJV) CGI		550	160	-	
	K3	податливый чугун (GJMW / GJMB)		500	150	-	
	K4	податливый чугун (GJMB)		800	240	-	
	K5	чугун с сфероидальным графит (GJS)		700	210	-	
	K6	чугун с сфероидальным графит (GJS) ADI		1400	420	45	
Цветные металлы							
N	N1	Сплав алюминия для пластической обработки		200	-	-	
	N2		PH	500	152	-	
	N3	Алюминиевый литейный сплав		250	75	-	
	N4		PH	300	90	-	
	N5			450	130	-	
	N6	Магниеые сплавы		250	70	-	
	N7	Медь и её сплавы	Технически чистая медь		350	100	-
	N8		Латунь , бронза		600	180	-
	N9		Сплав меди(короткая стружка)		400	120	-
	N10		Высокая выносливость		1000	300	32
Огнеупорные сплавы и сплавы титана							
S	S1	На основе - Fe	A	675	200	-	
	S2		PH	950	280	29	
	S3		A	850	250	25	
	S4		PH	1200	350	38	
	S5	PH	1100	320	34		
	S6	Сплавы титана	Чистый титан		675	200	-
	S7		Сплавы α и β		1250	375	40
	S8		Сплав - β		1400	410	44
S8							
Твердые материалы							
H	H1	Закаленная сталь	HT			50	
	H2		HT			55	
	H3		HT			60	
	H4		HT			55	















MASTER TAP						800X			800			FAN-I200		Наименование
B-HL	B-IKR-HL	C-R45-HL	C-R45-IK-HL	E-R45-HL	E-R45-IK-HL	C-TN2	B-TN2	C-R40-TN2	C	B	C-R40	B-TC	C-R40-TC	
														
15 / 16 35 / 36	15 / 16 35 / 36	15 / 16 35 / 36	15 / 16 35 / 36	15 / 16 35 / 36	15 / 16 35 / 36	17 / 18 37 / 38 / 39	17 / 18 37 / 38 / 39	17 / 18 37 / 38 / 39	19 / 20 40 / 41	19 / 20 / 23 40 / 41 / 42	21 / 22 / 23 40 / 41 / 42	24 43 / 44	24 43 / 44	M MF UNC UNF UN-8 UNEF G Rp RC NPT NPTF NPSF BSW BSF EG M EG UNC EG UNF Pg Tr
58 62		58 62					59 63	59 63		60 64	60 64			Страница
		68				69	69	69	70 74	67 70 74	67 70			
79 80 81				79 80 81						75 76 77	78			
HSSE-PM	HSSE-PM	HSSE-PM	HSSE-PM	HSSE-PM	HSSE-PM	HSSE	HSSE	HSSE	HSSE	HSSE	HSSE	HSSE-PM	HSSE-PM	Материал
B/4-5P	B/4-5P	C/2-3P	C/2-3P	E/1,5-2P	E/1,5-2P	C/2-3P	B/4-5P	C/2-3P	C/2-3P	B/4-5P	C/2-3P	B/4-5P	C/2-3P	Сбег резьбы
														Тип отверстия
< 3xD	< 3xD	< 2,5xD	< 2,5xD	< 2,5xD	< 2,5xD	< 1,5xD	< 3xD	< 2,5xD	< 1,5xD	< 3xD	< 2,5xD	< 3xD	< 2,5xD	Охлаждение
E/O/P	E/O/MQL	E/O/P	E/O/MQL	E/O/P	E/O/MQL	E/O/P	E/O/P	E/O/P	E/O/P	E/O/P	E/O/P	E/O/P	E/O/P	
Vc (m/min)														
10-40	20-50	10-40	20-50	10-40	20-50	10-35	10-35	10-35	5-20	5-20	5-20	10-35	10-35	P1
10-40	20-50	10-40	20-50	10-40	20-50	10-35	10-35	10-35	5-20	5-20	5-20	10-35	10-35	P2
10-40	20-50	10-40	20-50	10-40	20-50	10-35	10-35	10-35	5-20	5-20	5-20	10-35	10-35	P3
10-40	20-50	10-40	20-50	10-40	20-50	10-35	10-35	10-35	5-20	5-20	5-20	10-35	10-35	P4
10-40	20-50	10-40	20-50	10-40	20-50	5-20	5-20	5-20				5-20	5-20	P5
10-40	20-50	10-40	20-50	10-40	20-50	10-35	10-35	10-35	5-20	5-20	5-20	10-35	10-35	P6
10-40	20-50	10-40	20-50	10-40	20-50	5-20	5-20	5-20				5-20	5-20	P7
10-40	20-50	10-40	20-50	10-40	20-50							5-20	5-20	P8
5-15 ¹⁾	5-15 ¹⁾													P9
10-40	20-50	10-40	20-50	10-40	20-50	10-35	10-35	10-35	5-20	5-20	5-20	10-35	10-35	P10
10-40	20-50	10-40	20-50	10-40	20-50							5-20	5-20	P11
5-15 ¹⁾	5-15 ¹⁾													P12
5-15	5-25	5-15	5-25	5-15	5-25	5-15	5-15	5-15				5-15	5-15	P13
5-15	5-25	5-15	5-25	5-15	5-25	5-15	5-15	5-15				5-15	5-15	P14
5-15	5-25	5-15	5-25	5-15	5-25	5-15	5-15	5-15						M1
5-15	5-25	5-15	5-25	5-15	5-25	5-15	5-15	5-15				5-10	5-10	M2
5-15	5-25	5-15	5-25	5-15	5-25	5-15	5-15	5-15				5-10	5-10	M3
10-30	10-50	10-30	10-50	10-30	10-50	5-15	5-15		5-15	5-15		5-15	5-15	K1
10-30	10-50	10-30	10-50	10-30	10-50	5-15	5-15		5-15	5-15		5-15	5-15	K2
10-30	10-50	10-30	10-50	10-30	10-50	10-25	10-25	10-25	5-15	5-15	5-15	10-25	10-25	K3
10-30	10-50	10-30	10-50	10-30	10-50	10-25	10-25	10-25	5-15	5-15	5-15	10-25	10-25	K4
10-30	10-50	10-30	10-50	10-30	10-50	10-25	10-25	10-25	5-15	5-15	5-15	10-25	10-25	K5
5-15 ¹⁾	5-15 ¹⁾	5-15 ¹⁾	5-15 ¹⁾	5-15 ¹⁾	5-15 ¹⁾									K6
10-30	10-50	10-30	10-50	10-30	10-50									N1
10-30	10-50	10-30	10-50	10-30	10-50									N2
10-30	10-50	10-30	10-50	10-30	10-50	10-30	10-30		10-25	10-25		10-30	10-30	N3
10-30	10-50	10-30	10-50	10-30	10-50	10-30	10-30		10-25	10-25		10-30	10-30	N4
10-30	10-50	10-30	10-50	10-30	10-50	10-30	10-30		5-20	5-20		10-30	10-30	N5
10-30	10-50	10-30	10-50	10-30	10-50									N6
10-30	10-50	10-30	10-50	10-30	10-50	10-30	10-30	10-30	5-20	5-20	5-20	10-30	10-30	N7
10-30	10-50	10-30	10-50	10-30	10-50	10-30	10-30	10-30	5-20	5-20	5-20	10-30	10-30	N8
10-30	10-50	10-30	10-50	10-30	10-50									N9
5-25	5-25	5-25	5-25	5-25	5-25							10-30	10-30	N10
1-8 ¹⁾	1-8 ¹⁾	1-8 ¹⁾	1-8 ¹⁾	1-8 ¹⁾	1-8 ¹⁾									S1
1-8 ¹⁾	1-8 ¹⁾	1-8 ¹⁾	1-8 ¹⁾	1-8 ¹⁾	1-8 ¹⁾									S2
														S3
														S4
														S5
1-8 ¹⁾	1-8 ¹⁾	1-8 ¹⁾	1-8 ¹⁾	1-8 ¹⁾	1-8 ¹⁾									S6
														S7
														S8
														H1
														H2
														H3
														H4



















































Высокопроизводительные машинные метчики

Наименование		I400			INOX				GG					GAL			
		C-TC	B-TC	C-R15-TC	B	B-HL	C-R40	C-R40-HL	C-TC	C-IK-TC	E-TC	E-IK-TC	E-IKR-TC	C-R15-TC	E-R15-IK-TC		
																	
M		24	24	24	25 / 26	25 / 26	25 / 26	25 / 26	27	27	27	27	27	27	27		
MF		43 / 44	43 / 44	43 / 44	45 / 46 / 47	45 / 46 / 47	45 / 46 / 47	45 / 46 / 47	49	49	49	49	49	49	49		
UNC																	
UNF																	
UN-8																	
UNEF																	
G																	
Rp																	
RC																	
NPT																	
NPTF																	
NPSF																	
BSW																	
BSF																	
EG M																	
EG UNC																	
EG UNF																	
Pg																	
Tr																	
Страница																	
Материал		HSSE-PM	HSSE-PM	HSSE-PM	HSSE	HSSE	HSSE	HSSE	HSSE-PM	HSSE-PM	HSSE-PM	HSSE-PM	HSSE-PM	HSSE-PM	HSSE-PM		
Сбег резьбы		C/2-3P	B/4-5P	C/2-3P	B/4-5P	B/4-5P	C/2-3P	C/2-3P	C/2-3P	C/2-3P	E/1,5-2P	E/1,5-2P	E/1,5-2P	C/2-3P	E/1,5-2P		
Тип отверстия																	
Охлаждение		E/O/P	E/O	E/O/P	E/O/P	E/O/P	E/O/P	E/O/P	E/O	E/O/MQL	E/O	E/O/MQL	E/O/MQL	E/O/P	E/O/MQL		
Vc (m/min)																	
P		P1															
		P2															
		P3															
		P4															
		P5	5-20	5-20	5-20												
		P6															
		P7	5-20	5-20	5-20												
		P8	5-20	5-20	5-20												
		P9	1-5	1-5	1-5												
		P10															
		P11	5-20	5-20	5-20												
		P12	1-5	1-5	1-5												
		P13															
		P14															
M		M1			5-15	5-25	5-15	5-25									
		M2	5-10	5-10	5-10	5-15	5-25	5-15	5-25								
		M3	1-8	1-8	1-8	5-10	5-10	5-10	5-10								
K		K1	10-20	10-20	10-20				20-60	20-60	20-60	20-60	20-60				
		K2							15-30	15-30	15-30	15-30	15-30				
		K3	10-20	10-20	10-20					15-30	15-30	15-30	15-30	15-30			
		K4	10-20	10-20	10-20					15-30	15-30	15-30	15-30	15-30			
		K5	10-20	10-20	10-20					15-30	15-30	15-30	15-30	15-30			
		K6	1-5	1-5	1-5					5-10	5-10	5-10	5-10	5-10			
N		N1															
		N2															
		N3															
		N4												10-30	10-30		
		N5												10-30	10-30		
		N6												10-30	10-30		
		N7															
		N8															
		N9	10-20	10-20	10-20												
		N10															
S		S1															
		S2															
		S3															
		S4															
		S5															
		S6															
		S7															
		S8															
H		H1															
		H2															
		H3															
		H4															

HRC60				S-NC			DIN-352	Ms	NUTAP	NGMF	NGST	KOMBI	BIT	Наименование
C-HM-TC	C-IK-HM-TC	D-HM-TC	D-IK-HM-TC	B-TC	C-R45-TC	C-R45-IK-TC					трапеция			
28	28	28	28	29 50 / 51	29 50 / 51	29 50 / 51	30 52 / 53 / 54 61 65		31 55	32 56 / 57		33	34	M MF UNC UNF UN-8 UNEF G Rp RC NPT NPTF NPSF BSW BSF EG M EG UNC EG UNF Pg Tr
							72	71						
VHM C/2-3P	VHM C/2-3P	VHM D/3,5-5P	VHM D/3,5-5P	HSSE-PM B/4-5P	HSSE-PM C/2-3P	HSSE-PM C/2-3P	HSS ~3P	HSSE F/1P	HSSE 12P	HSS 12P	HSS 24P	HSS D/4P	HSS D/4P	Материал Сбег резьбы
														Тип отверстия
< 1,5xD	< 1,5xD	< 1,5xD	< 1,5xD	< 2,5xD	< 3xD	< 3xD	< 1,5xD	< 2xD	< 1,5xD	< 1,5xD	< 2xD	< 1,5xD	< 1,5xD	Охлаждение
E/O/P	E/O/MQL	E/O/P	E/O/MQL	E/O/P	E/O/P	E/O/MQL	E/O/P	E/O/P	E/O/P	E/O/P	E/O/P	E/O/P	E/O/P	
				Vc (m/min)										
				10-50	10-50	20-60	5-20		5-20	5-20	5-20	5-15	5-15	P1
				10-50	10-50	20-60	5-20		5-20	5-20	5-20	5-15	5-15	P2
				10-50	10-50	20-60	5-20		5-20	5-20	5-20	5-15	5-15	P3
				10-50	10-50	20-60	5-20		5-20	5-20	5-20	5-15	5-15	P4
				10-50	10-50	20-60			5-15					P5
				10-50	10-50	20-60	5-20		5-20	5-20	5-20	5-15	5-15	P6
				10-50	10-50	20-60			5-15					P7
				10-50	10-50	20-60			5-10					P8
				5-15 ¹⁾										P9
				10-50	10-50	20-60	5-20		5-20	5-20	5-20	5-15	5-15	P10
				10-50	10-50	20-60			5-15					P11
				5-15 ¹⁾										P12
				5-20	5-20	5-30								P13
				5-15	5-15	5-25								P14
				5-20	5-20	5-30								M1
				5-15	5-15	5-25								M2
				5-20	5-20	5-30								M3
				10-40	10-40	10-60				6-15	6-15			K1
				10-40	10-40	10-60								K2
				10-40	10-40	10-60								K3
				10-40	10-40	10-60								K4
				10-40	10-40	10-60								K5
				5-15 ¹⁾	5-15 ¹⁾	5-15 ¹⁾								K6
				10-40	10-40	10-60								N1
				10-40	10-40	10-60								N2
				10-40	10-40	10-60								N3
				10-40	10-40	10-60								N4
				10-40	10-40	10-60								N5
				10-40	10-40	10-60								N6
				10-40	10-40	10-60								N7
				10-40	10-40	10-60		10-25		6-15	6-15	6-15	6-15	N8
				10-40	10-40	10-60								N9
				5-25	5-25	5-30								N10
				1-8 ¹⁾	1-8 ¹⁾	1-8 ¹⁾								S1
				1-8 ¹⁾	1-8 ¹⁾	1-8 ¹⁾								S2
														S3
														S4
														S5
				1-8 ¹⁾	1-8 ¹⁾	1-8 ¹⁾								S6
														S7
														S8
1-4	1-4	1-4	1-4											H1
1-4	1-4	1-4	1-4											H2
1-4	1-4	1-4	1-4											H3
1-4	1-4	1-4	1-4											H4

Страница

Наименование		WGN					CTM	
		C-TN2	C-SR-TN2	C-SR-TC	E-SR-TC	E-SR-IK-TC	E-SR-IKR-TC	
								
Страница	M	85	85	85	85	85	85	92
	MF		86	86				92
	UNC		87					
	UNF		88					
	UNEF							
	G		89					
Материал		PM/HSSE	PM/HSSE	PM/HSSE	PM/HSSE	PM/HSSE	PM/HSSE	VHM
Сбег резьбы		C/2-3P	C/2-3P	C/2-3P	E/1,5-2P	E/1,5-2P	E/1,5-2P	-
Тип отверстия		 < 3xD	 < 3xD	 < 3xD	 < 3xD	 < 3xD	 < 3xD	 < 3xD
Охлаждение		E/O	E/O	E/O	E/O	E/O/MQL	E/O/MQL	E/O
		Vc (m/min)						
P	P1	10-30	10-30	10-30	10-30	15-50	15-50	100-250
	P2	10-30	10-30	10-30	10-30	15-50	15-50	100-250
	P3	10-30	10-30	10-30	10-30	15-50	15-50	100-250
	P4	10-30	10-30	10-30	10-30	15-50	15-50	100-250
	P5	10-25	10-25	10-25	10-25	10-30	10-30	100-250
	P6	10-30	10-30	10-30	10-30	15-50	15-50	110-180
	P7	10-25	10-25	10-25	10-25	10-30	10-30	110-180
	P8							110-180
	P9							110-180
	P10	10-30	10-30	10-30	10-30	15-50	15-50	90-160
	P11			10-25	10-25	10-30	10-30	90-160
	P12							90-160
	P13			10-25	10-25	10-30	10-30	60-160
	P14							60-160
M	M1	10-25	10-25	10-25	10-25	10-25	10-25	60-120
	M2	10-25	10-25	10-25	10-25	10-25	10-25	60-120
	M3			10-25	10-25	10-25	10-25	60-120
K	K1							70-150
	K2							70-150
	K3							70-150
	K4							70-150
	K5							70-150
	K6							70-150
N	N1	20-40	20-40	20-60	20-60	20-60	20-60	150-350
	N2	20-40	20-40	20-60	20-60	20-60	20-60	150-350
	N3	20-40	20-40	20-60	20-60	20-60	20-60	150-350
	N4			20-60	20-60	20-60	20-60	150-350
	N5			20-60	20-60	20-60	20-60	150-350
	N6							150-350
	N7	20-40	20-40	20-60	20-60	20-60	20-60	150-350
	N8	20-40	20-40	20-60	20-60	20-60	20-60	150-350
	N9							
	N10							
S	S1							20-80
	S2							20-80
	S3							20-80
	S4							20-80
	S5							20-80
	S6							20-80
	S7							20-80
	S8							20-80
H	H1							
	H2							
	H3							
	H4							

		INOX		HRC40		Наименование
KPL/2	KPL/3	KPL/3-P	KPL/3-P-TN2	KPL/3-P-TC		
						
95 / 96 / 97	95 / 96 / 97	98	99	100		M
101 / 102 / 103				104		MF
	105					UNC
106						UNF
107		108		109		G
	110					BSW
111						BSF
112						Pg
HSS C/2-3P	HSS C/2-3P	HSSE C/2-3P	HSSE C/2-3P	HSSE-PM C/2-3P		Материал
 < 2,5xD	 < 2,5xD	 < 2,5xD	 < 2,5xD	 < 1,5xD		Сбег резьбы
E/O/P	E/O/P	E/O/P	E/O/P	E/O/P		Тип отверстия
						P1
						P2
						P3
						P4
						P5
						P6
						P7
						P8
						P9
						P10
						P11
						P12
						P13
						P14
						M1
						M2
						M3
						K1
						K2
						K3
						K4
						K5
						K6
						N1
						N2
						N3
						N4
						N5
						N6
						N7
						N8
						N9
						N10
						S1
						S2
						S3
						S4
						S5
						S6
						S7
						S8
						H1
						H2
						H3
						H4

Страница

P





M

K

N

S

H

Наименование		800	800 SPN	Ms	INOX
					
Странлица	M	115	115	115	115
	MF	116 / 117 / 118	116 / 117 / 118	116 / 117 / 118	116 / 117 / 118
	UNC	119			
	UNF	120			
	G	121	121	121	121
	R	122			
	BSW	123			
	BSF	124			
	NPT	125			
Исполнение		Подточка передней поверхности	Специальная геометрия	Специальная геометрия	
Материал	HSS	HSS	HSS	HSSE	
Сбег резьбы	1,75P	1,75P	1,25P	2,25P	
Охлаждение	E/O/P	E/O/P	E/O/P	E/O/P	
P	P1	4-8	4-8		4-8
	P2	3-6	3-6		3-6
	P3	3-6	3-6		3-6
	P4	2-5	2-5		3-6
	P5	2-5	2-5		3-6
	P6				
	P7				
	P8				
	P9				
	P10	1-3	1-3		1-5
	P11				1-5
	P12				
	P13				2-6
	P14				2-6
M	M1				2-6
	M2				2-6
	M3				
K	K1			5-8	
	K2			5-8	
	K3			5-8	
	K4			2-5	
	K5			2-5	
	K6				
N	N1				
	N2				
	N3	10-20	10-20		10-20
	N4	10-20	10-20		10-20
	N5				5-15
	N6				1-5
	N7	7-12	7-12	10-15	10-15
	N8	10-15	10-15	12-18	10-15
	N9			20-30	15-25
	N10			6-10	8-12
S	S1				
	S2				
	S3				
	S4				
	S5				
	S6				
	S7				
	S8				
H	H1				
	H2				
	H3				
	H4				

MASTERDRILL		I300						I300 micro	AL	INOX				
DIN-6537 3xD	DIN-6537 5xD	DIN-6597 3xD	DIN-6597 3xD	DIN-6537 5xD	DIN-6537 5xD	DIN-6537 8xD	DIN-6537	DIN-6539	DIN-6597 5xD	DIN-6597 5xD	DIN-338	DIN-338	Стандарт	
m7	m7	m7	m7	m7	m7	m7	m7	h7	m7	m7	h8	h8	Точность	
129 / 130 / 131	132 / 133 / 134	129 / 130 / 131	129-131	132-134	132-134	135 / 136 / 137	139 / 140 / 141	138	142 / 143 / 144	142 / 143 / 144	145 / 146 / 147	145 / 146 / 147	Страница	
λ35°±40° δ140°	λ35°±40° δ140°	λ35°±40° δ140°	λ35°±40° δ140°	λ35°±40° δ140°	λ35°±40° δ140°	λ35°±40° δ140°	λ35°±40° δ140°	λ35°±40° δ118°	λ15° δ130°	λ15° δ130°	λ36° δ130°	λ36° δ130°	Геометрия	
IK	IK		IK		IK	IK			IK	IK			Внешнее охлаждение	
VHM	VHM	VHM	VHM	VHM	VHM	VHM	VHM	VHM	VHM	VHM	HSSE	HSSE	Материал	
AT	AT	AT	AT	AT	AT	AT	AT	-	-	TB	-	TN2	Покрытие	
3+20	3+20	3+20	3+20	3+20	3+20	3+20	2,35+14	0,75+2,9	3+20	3+20	1+16	1+16	Диапазон диаметров	
													Vc (m/min)	
110 c	100 c	70 c	90 c	60 c	80 c	50 c	70 a	55 a	-	-	35 c	40 c	P1	
110 c	100 c	70 c	90 c	60 c	80 c	50 c	70 a	55 a	-	-	28 b	32 b	P2	
100 c	90 c	70 c	90 c	60 c	80 c	50 c	70 a	55 a	-	-	28 b	32 b	P3	
110 c	100 c	50 b	70 b	45 b	60 b	40 b	50 a	40 a	-	-	18 b	21 b	P4	
100 c	90 c	50 b	70 b	45 b	60 b	40 b	50 a	40 a	-	-	18 b	21 b	P5	
95 c	85 c	50 b	70 b	45 b	60 b	40 b	50 a	40 a	-	-	18 b	21 b	P6	
85 c	75 c	40 b	50 b	35 b	40 b	30 b	40 a	30 a	-	-	-	-	P7	
65 c	55 c	40 b	50 b	35 b	40 b	30 b	40 a	30 a	-	-	-	-	P8	
65 c	55 c	30 b	40 b	30 b	35 b	25 b	30 a	25 a	-	-	-	-	P9	
60 c	50 c	50 b	70 b	45 b	60 b	40 b	50 a	40 a	-	-	18 b	21 b	P10	
55 c	45 c	40 b	50 b	35 b	40 b	30 b	40 a	30 a	-	-	-	-	P11	
55 c	45 c	30 b	40 b	30 b	35 b	25 b	30 a	25 a	-	-	-	-	P12	
60 c	50 c	50 b	60 b	45 b	55 b	40 b	50 a	40 a	-	-	13 b	15 b	P13	
60 c	50 c	50 b	60 b	45 b	55 b	40 b	50 a	40 a	-	-	13 b	15 b	P14	
60 b	50 b	30 b	40 b	30 b	35 b	25 b	30 a	25 a	-	-	10 b	12 b	M1	
60 b	50 b	-	-	-	-	-	-	-	-	-	-	-	M2	
60 b	50 b	30 b	40 b	30 b	35 b	25 b	30 a	25 a	-	-	-	-	M3	
120 d	110 d	100 d	120 d	90 d	110 d	80 d	100 b	80 b	-	-	35 d	40 d	K1	
95 d	85 d	-	-	-	-	-	-	-	-	-	-	-	K2	
120 d	110 d	80 d	100 d	70 d	90 d	60 d	80 b	60 b	-	-	-	-	K3	
100 d	90 d	80 d	100 d	70 d	90 d	60 d	80 b	60 b	-	-	-	-	K4	
85 d	75 d	65 d	80 d	60 d	70 d	50 d	65 b	50 b	-	-	-	-	K5	
85 d	75 d	65 d	80 d	60 d	70 d	50 d	65 b	50 b	-	-	-	-	K6	
250 e	220 e	200 e	250 e	180 e	220 e	160 e	200 b	160 b	250 e	250 e	37 d	43 d	N1	
250 e	220 e	200 e	250 e	180 e	220 e	160 e	200 b	160 b	250 e	250 e	37 d	43 d	N2	
250 e	220 e	200 e	250 e	180 e	220 e	160 e	200 b	160 b	250 e	250 e	27 c	31 c	N3	
250 e	220 e	200 e	250 e	180 e	220 e	160 e	200 b	160 b	250 e	250 e	27 c	31 c	N4	
200 e	180 e	160 e	200 e	150 e	180 e	130 e	160 a	125 a	200 e	200 e	32 d	37 d	N5	
200 e	180 e	-	-	-	-	-	-	-	150 d	150 d	-	-	N6	
120 c	110 d	100 c	120 c	90 c	110 c	80 c	100 b	80 b	200 c	200 c	38 c	44 c	N7	
150 c	135 c	120 c	150 c	110 c	135 c	100 c	120 b	100 b	200 c	200 c	41 b	47 b	N8	
150 c	135 c	120 c	150 c	110 c	135 c	100 c	120 b	100 b	200 c	200 c	41 b	47 b	N9	
150 c	135 c	-	-	-	-	-	-	-	200 c	200 c	-	-	N10	
25 a	22 a	20 a	25 a	18 a	22 a	15 a	20 a	16 a	-	-	9 b	10 b	S1	
25 a	22 a	20 a	25 a	18 a	22 a	15 a	20 a	16 a	-	-	9 b	10 b	S2	
25 a	22 a	-	-	-	-	-	-	-	-	-	-	-	S3	
25 a	22 a	-	-	-	-	-	-	-	-	-	-	-	S4	
25 a	22 a	-	-	-	-	-	-	-	-	-	-	-	S5	
60 b	50 b	40 b	50 b	35 b	45 b	30 b	40 a	30 a	-	-	24 b	28 b	S6	
60 b	50 b	30 b	40 b	30 b	35 b	25 b	30 a	25 a	-	-	12 a	14 a	S7	
60 b	50 b	30 b	40 b	30 b	35 b	25 b	30 a	25 a	-	-	12 a	14 a	S8	
-	-	-	-	-	-	-	-	-	-	-	-	-	H1	
-	-	-	-	-	-	-	-	-	-	-	-	-	H2	
-	-	-	-	-	-	-	-	-	-	-	-	-	H3	
-	-	-	-	-	-	-	-	-	-	-	-	-	H4	













	WST	WDG	Центровочные сверла			Инструмент для снятия фасок и заусенцев		Зенкеры					Конические развертки
	 Ступенчатое сверло	 Сверла для извлечения сломанных метчиков											
Стандарт			NC	NC	DIN-333A	DIN-6537L	DIN-6537L	DIN-335	DIN-335	DIN-335		DIN-373	
Точность													
Страница	148	149	150	150	151	152	152	153	153	153	155	156	157
Геометрия			δ90°	δ120°		δ60°	δ90°	δ90°	δ90°	δ90°	δ30/45/60°		
Внешнее охлаждение													
Материал	HSS	VHM	HSSE	HSSE	HSS	VHM	VHM	HSS/HSSE	HSS/HSSE	HSSE-Co8		HSS	HSS
Покрытие	-	AT	TN2	TN2	-	AT	AT	-	TN2	TC	-	-	-
Диапазон диаметров		2,5+10,2	3+16	2,5+10,2	0,8+10	4+20	4+20						

ТАБЛИЦА РЕКОМЕНДОВАННЫХ ПОДАЧ ММ/ОБОРОТ В ЗАВИСИМОСТИ ОТ ДИАМЕТРА ИНСТРУМЕНТА

Группа	Диаметр сверла											
	1	2	3	4	5	6	8	10	12	14	16	20
a	0,015	0,030	0,038	0,047	0,053	0,060	0,075	0,090	0,100	0,120	0,127	0,160
b	0,020	0,050	0,070	0,085	0,100	0,120	0,150	0,180	0,200	0,230	0,250	0,270
c	0,023	0,080	0,100	0,130	0,150	0,180	0,250	0,270	0,280	0,300	0,330	0,370
d	0,030	0,100	0,160	0,180	0,220	0,240	0,300	0,370	0,400	0,450	0,480	0,500
e	0,035	0,120	0,200	0,250	0,270	0,300	0,350	0,450	0,470	0,500	0,530	0,550
f	0,050	0,150	0,220	0,250	0,320	0,400	0,490	0,620	0,650	0,720	0,850	0,900
g	0,070	0,160	0,250	0,270	0,360	0,470	0,620	0,830	0,900	0,950	1,100	1,200
h	0,090	0,200	0,270	0,300	0,400	0,520	0,750	1,000	1,100	1,200	1,300	1,350

Обозначение группы подачи в зависимости от диаметра инструмента дает рекомендованную скорость резания



		MASTER TAP						SBOXX						BOO				FAN-I200				Название / Name
		B-HL	B-NR-HL	C-R45-HL	C-R45-K-HL	E-R45-HL	E-R45-K-HL	C-TN	B-TN	C-R40-TN	C	B	C-R40	B-TC	C-R40-TC							
Steel	P1	15/16	15/16	15/16	15/16	15/16	15/16	17/18	17/18	17/18	19/20	19/20	21/22	23/24	24					M		
	P2	37/36	35/36	35/36	35/36	35/36	35/36	37/39	37/39	37/39	38/41	38/41	38/41	42/44	43/44					MF		
	P3	58	58	58	58	58	58	58	58	58	60	60	60	60	60					UNF		
	P4	62	62	62	62	62	62	63	63	63	64	64	64	64	64					LINEF		
	P5	68	68	68	68	68	68	66	66	66	67	67	67	67	67					UNF		
	P6	74	74	74	74	74	74	66	66	66	67	67	67	67	67					UNF		
	P7	79	79	79	79	79	79	69	69	69	70	70	70	70	70					NPT		
	P8	80	80	80	80	80	80	66	66	66	67	67	67	67	67					NPT		
	P9	81	81	81	81	81	81	79	79	79	77	77	77	77	77					NPT		
	P10	81	81	81	81	81	81	79	79	79	77	77	77	77	77					NPT		



Range of application - material

	Steel	Stainless steel	Cast iron	Nonferrous metals	Superalloys and titanium	Hard materials
P1	Free cutting steel C ≤ 0.55 %	Ferritic/martensitic	Gray cast iron (GJL)	Aluminum wrought alloys	Fe-based	H1
P2	Free cutting steel C > 0.55 %	Martensitic	Malleable cast iron (GJMB)	Cast aluminum alloys	Ni / Co base	H2
P3	Free cutting steel C ≤ 0.55 %		Malleable cast iron (GJMB)	Magnesium alloys	Pure titanium	H3
P4	Free cutting steel C > 0.55 %		Cast iron with spherical graphite (GJS)	Copper and copper alloys	α and β alloys	H4
P5	Low alloyed steel		Cast iron with nodular graphite (GJS)	High strength		H5
P6	High alloyed steel and high alloyed tool steel		Nonferrous metals			H6
P7						H7
P8						H8
P9						H9
P10						H10
P11						H11
P12						H12
P13						H13
P14						H14



ISO Metric thread DIN-13		BOO					
		C	C-LH	B	B-LH	B	B
Material	HSSE	HSSE	HSSE	HSSE	HSSE	HSSE	HSSE
Hole type							
Material	HSSE	HSSE	HSSE	HSSE	HSSE	HSSE	HSSE
Coating							
Chamfer	C / 2-3P	C / 2-3P	B / 4-5P	B / 4-5P	B / 4-5P	B / 4-5P	B / 4-5P
M	P	I ₁	I ₂	I ₃	d ₂	a	INDEX
Tolerancia / Tolerance		C4-121102	C4-111102				
M1	0.25 40 6	-	2.5	2.1	0.75	0010	●
M1.1	0.25 40 6	-	2.5	2.1	0.85	0011	●
M1.2	0.25 40 6	-	2.5	2.1	0.95	0012	●
M1.4	0.30 40 7	-	2.5	2.1	1.10	0014	●
M1.6	0.35 40 8	-	2.5	2.1	1.25	0016	●
M1.7	0.35 40 8	-	2.5	2.1	1.35	0017	●
M1.8	0.35 40 8	-	2.5	2.1	1.45	0018	●
M2	0.40 45 10	-	2.8	2.1	1.60	0020	●
M2.2	0.45 45 10	-	2.8	2.1	1.75	0022	●
M2.3	0.40 45 10	-	2.8	2.1	1.90	0023	●
M2.5	0.45 50 9	-	2.8	2.1	2.05	0025	●
M2.6	0.45 50 9	-	2.8	2.1	2.15	0026	●
M3	0.50 56 10	-	18	3.5	2.7	2.50	0030
M3.5	0.60 56 12	-	20	4.0	3.0	2.90	0035
M4	0.70 63 12	-	21	4.5	3.4	3.30	0040
M4.5	0.75 70 14	-	25	6.0	4.9	3.80	0045
M5	0.80 70 14	-	25	6.0	4.9	4.20	0050
M6	1.00 80 18	-	30	7.0	5.5	5.00	0060
M7	1.00 80 18	-	30	7.0	5.5	6.00	0070
M8	1.25 90 20	-	35	8.0	6.2	6.80	0080
M9	1.25 90 20	-	35	9.0	7.0	7.80	0090
M10	1.50 100 20	-	39	10.0	8.0	8.50	0100



ISO	M4.5	0.75	70	14	-	25	6.0	4.9	3.80	0045	●	●	●	●	●	●
M5	0.80	70	14	-	25	6.0	4.9	4.20	0050	●	●	●	●	●	●	●
M6	1.00	80	18	-	30	6.0	4.9	5.00	0060	●	●	●	●	●	●	●
M7	1.00	80	18	-	30	7.0	5.5	6.00	0070	●	●	●	●	●	●	●
M8	1.25	90	20	-	35	8.0	6.2	6.80	0080	●	●	●	●	●	●	●
M9	1.25	90	20	-	35	9.0	7.0	7.80	0090	●	●	●	●	●	●	●
M10	1.50	100	20	-	39	10.0	8.0	8.50	0100	●	●	●	●	●	●	●

ISO	5-35	5-20	5-20	5-20	5-20	5-20
P	5-35	5-20	5-20	5-20	5-20	5-20
M	5-15	-	-	-	-	-
K	10-25	5-15	5-15	5-15	5-15	5-15
N	10-35	5-25	5-25	5-25	5-25	5-25
S						

1. Выберите в таблице обрабатываемый материал
2. Выберите вариант исполнения инструмента
3. Найдите в таблице номер страницы для выбранного типа метчика
4. Найдите на указанной странице требуемое исполнение инструмента
5. Выберите требуемый размер резьбы и ее шаг
6. Запишите обозначение и индекс (артикул) инструмента
7. Read recommended cutting data

6 Пример
C2-221101-0080
800 M8-6H DIN-371 C LH HSSE

СОДЕРЖАНИЕ

МАШИННЫЕ МЕТЧИКИ



13-82

1

МЕТЧИКИ-РАСКАТНИКИ



84-89

2

РЕЗЬБОВЫЕ ФРЕЗЫ



91-92

3

РУЧНЫЕ МЕТЧИКИ



93-112

4

КРУГЛЫЕ ПЛАШКИ



113-125

5

ИНСТРУМЕНТ ДЛЯ СВЕРЛЕНИЯ

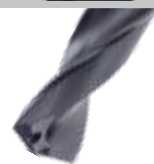

127-157

6

КАЛИБРЫ



159-173

7

ДЕРЖАТЕЛИ ИНСТРУМЕНТА



175-200

8

НАБОРЫ ИНСТРУМЕНТОВ



201-210

9

СПЕЦИАЛЬНЫЕ СРЕДСТВА, ПРИСПОСОБЛЕНИЯ,
СТАНКИ



211-220

10

ТЕХНИЧЕСКАЯ ИНФОРМАЦИЯ



221-284

11

Машинные метчики



ТАБЛИЦА ПОДБОРА ИНСТРУМЕНТА

1-8

СТРАНИЦА КАТАЛОГА

15-82

M	DIN-371 DIN-376	Высокопроизводительные машинные метчики	MASTER TAP 800X 800	15-22
	DIN-371 EL DIN-376 EL	Высокопроизводительные машинные метчики, экстра-длинные	800	23
	DIN-371 DIN-376	Высокопроизводительные машинные метчики	FAN-1200 1400 INOX GG GAL HRC60 S-NC	24-29
	DIN-352	Короткие машинные метчики		30
	NUT-TAP NGMf KOMBI BIT	Гаечные метчики Комбинированные метчики (метчики-сверла) Машинные метчики-биты	NUT-TAP BIT KOMBI	31-34
MF	DIN-371 DIN-374	Высокопроизводительные машинные метчики	MASTER TAP 800X 800 FAN-1200 1400 INOX GG GAL S-NC	35-57
	DIN-2181	Короткие машинные метчики		52-54
	NUT-TAP NGMf	Гаечные метчики	NUT-TAP NGMf	55-57
UNC	DIN-371 DIN-376	Высокопроизводительные машинные метчики	MASTER TAP 800X 800	58-60
	DIN-352	Короткие машинные метчики		61
UNF	DIN-371 DIN-374	Высокопроизводительные машинные метчики	MASTER TAP 800X 800	62-64
	DIN-2181	Короткие машинные метчики		65
UNEF	~DIN-374	Высокопроизводительные машинные метчики	800X 800	66-67
G	DIN-5156	Высокопроизводительные машинные метчики	MASTER TAP 800X 800	68-70
	~DIN-5157	Короткие машинные метчики	Ms	71
	DIN-5157	Короткие машинные метчики		72
	NGRf	Короткие машинные метчики	NGRf	73
Rp/Rc	DIN-5156	Высокопроизводительные машинные метчики	800	74
	~DIN-5156	Высокопроизводительные машинные метчики	800	74
NPT	~DIN-371 ~DIN-374	Высокопроизводительные машинные метчики	800	75
NPTF	~DIN-374	Высокопроизводительные машинные метчики	800	76
NPSF	~DIN-5156	Высокопроизводительные машинные метчики	800	77
BSW	DIN-371 DIN-376	Высокопроизводительные машинные метчики	800	78
EG ^M _{STI}	~DIN-371 ~DIN-376	Высокопроизводительные машинные метчики	MASTER TAP	79
EG ^{UNC} _{STI}	~DIN-371 ~DIN-376	Высокопроизводительные машинные метчики	MASTER TAP	80
EG ^{UNF} _{STI}	~DIN-371 ~DIN-376	Высокопроизводительные машинные метчики	MASTER TAP	81
TR	NGSt	Короткие машинные метчики	NGSt	82

MASTER TAP

Основная метрическая резьба ISO DIN-13									MASTER TAP						
									B-HL	B-IKR-HL	C-R45-HL	C-R45-IK-HL	E-R45-HL	E-R45-IK-HL	
Обрабатываемые материалы															
Тип отверстия															
Изготовлен из									HSSE-PM HSSE-PM HSSE-PM HSSE-PM HSSE-PM HSSE-PM						
Покрытие									HL HL HL HL HL HL						
Сбег резьбы									B / 4-5P B / 4-5P C / 2-3P C / 2-3P E / 1,5-2P E / 1,5-2P						
M _{d1}	P	l ₁	l ₂	l ₃	d ₂	a		норма	DIN-371						
									Точность	ISO1(4H)		ISO1(4H)			
									INDEX C4-118M02						
M1	0,25	40	6	13	2,5	2,1	0,75	0010	●		●				
M1,1	0,25	40	6	13	2,5	2,1	0,85	0011	●		●				
M1,2	0,25	40	6	13	2,5	2,1	0,95	0012	●		●				
M1,4	0,30	40	8	13	2,5	2,1	1,10	0014	●		●				
M _{d1}	P	l ₁	l ₂	l ₃	d ₂	a		норма	DIN-371						
									Точность	ISO2 (6H)		ISO2 (6H)			
									INDEX C4-118M01						
M1,6	0,35	40	8	13	2,5	2,1	1,25	0016	●		●				
M1,7	0,35	40	8	13	2,5	2,1	1,35	0017	●		●				
M1,8	0,35	40	8	13	2,5	2,1	1,45	0018	●		●				
M2	0,40	45	10	13	2,8	2,1	1,60	0020	●		●				
M2,2	0,45	45	10	13	2,8	2,1	1,75	0022	●		●				
M2,3	0,40	45	10	13	2,8	2,1	1,90	0023	●		●				
M2,5	0,45	50	9	14	2,8	2,1	2,05	0025	●		●				
M2,6	0,45	50	9	14	2,8	2,1	2,15	0026	●		●				
M _{d1}	P	l ₁	l ₂	l ₃	d ₂	a		норма	DIN-371						
									Точность	6HX	6HX	6HX	6HX	6HX	6HX
									INDEX C4-118M01 C4-118M61 C4-528M01 C4-528M51 C4-718M01 C4-718M51						
M3	0,50	56	5	18	3,5	2,7	2,50	0030	●	-	●	-	●	-	
M3,5	0,60	56	6	20	4,0	3,0	2,90	0035	●	-	●	-	●	-	
M4	0,70	63	7	21	4,5	3,4	3,30	0040	●	-	●	-	●	-	
M4,5	0,75	70	7,5	25	6,0	4,9	3,80	0045	●	-	●	-	●	-	
M5	0,80	70	8	25	6,0	4,9	4,20	0050	●	●	●	●	●	○	
M6	1,00	80	10	30	6,0	4,9	5,00	0060	●	●	●	●	●	○	
M7	1,00	80	10	30	7,0	5,5	6,00	0070	●	○	○	○	○	○	
M8	1,25	90	13	35	8,0	6,2	6,80	0080	●	●	●	●	●	○	
M9	1,25	90	13	35	9,0	7,0	7,80	0090	○	○	○	○	○	○	
M10	1,50	100	15	39	10,0	8,0	8,50	0100	●	●	●	●	●	○	
									ISO Vc (m/min)						
									P	5-40	5-50	5-40	5-50	5-40	5-50
									M	5-15	5-25	5-15	5-25	5-15	5-25
									K	10-30	10-50	10-30	10-50	10-30	10-50
									N	10-30	10-50	10-30	10-50	10-30	10-50
									S	1-8	1-8	1-8	1-8	1-8	1-8

- Доступно со склада
- По запросу

Пример заказа
C4-118M01-0100
MasterTAP M10-6HX DIN-371 B HSSE-PM HL

Основная метрическая резьба ISO DIN-13

HSSE
PM

HL

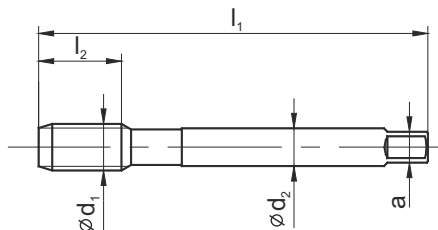
DIN
376

MASTER TAP

B-HL B-IKR-HL C-R45-HL C-R45-IK-HL E-R45-HL E-R45-IK-HL



Обрабатываемые материалы



Тип отверстия



Изготовлен из

HSSE-PM HSSE-PM HSSE-PM HSSE-PM HSSE-PM HSSE-PM

Покрытие

HL HL HL HL HL HL

Сбег резьбы

B / 4-5P B / 4-5P C / 2-3P C / 2-3P E / 1,5-2P E / 1,5-2P

M d ₁	P	l ₁	l ₂	l ₃	d ₂	a		норма	DIN-376						
									Точность	6HX	6HX	6HX	6HX	6HX	6HX
									INDEX	D4-118M01	D4-118M61	D4-528M01	D4-528M51	D4-718M01	D4-718M51
M8	1,25	90	15	-	6,0	4,9	6,80	0080	●	○	●	○	○	○	
M10	1,50	100	17	-	7,0	5,5	8,50	0100	●	○	●	○	○	○	
M12	1,75	110	18	-	9,0	7,0	10,20	0120	●	●	●	●	●	○	
M14	2,00	110	20	-	11,0	9,0	12,00	0140	●	●	●	●	●	○	
M16	2,00	110	20	-	12,0	9,0	14,00	0160	●	●	●	●	●	○	
M18	2,50	125	25	-	14,0	11,0	15,50	0180	●	○	●	○	○	○	
M20	2,50	140	25	-	16,0	12,0	17,50	0200	●	○	●	○	○	○	
M22	2,50	140	25	-	18,0	14,5	19,50	0220	●	○	●	○	○	○	
M24	3,00	160	30	-	18,0	14,5	21,00	0240	●	○	●	○	○	○	
M27	3,00	160	30	-	20,0	16,0	24,00	0270	●	○	●	○	○	○	
M30	3,50	180	35	-	22,0	18,0	26,50	0300	●	○	●	○	○	○	
M33	3,50	180	35	-	25,0	20,0	29,50	0330	●	○	●	○	○	○	
M36	4,00	200	40	-	28,0	22,0	32,00	0360	●	○	●	○	○	○	

ISO	V _c (m/min)					
P	5-40	5-50	5-40	5-50	5-40	5-50
M	5-15	5-25	5-15	5-25	5-15	5-25
K	10-30	10-50	10-30	10-50	10-30	10-50
N	10-30	10-50	10-30	10-50	10-30	10-50
S	1-8	1-8	1-8	1-8	1-8	1-8

Пример заказа

D4-118M01-0120
MasterTAP M12-6H DIN-376 B HSSE-PM HL● Доступно со склада
○ По запросу



Основная метрическая резьба ISO DIN-13										800X							
										C-TN2	B-TN2	C-R40-TN2					
Обрабатываемые материалы																	
Тип отверстия																	
Изготовлен из										HSSE							
Покрытие										TN2							
Сбег резьбы										C / 2-3P B / 4-5P C / 2-3P							
M d ₁	P	l ₁	l ₂	l ₂ R40	l ₃	d ₂	a		норма	DIN-371							
										Точность	ISO2 (6H)	ISO2 (6H)	ISO2 (6H)				
										INDEX	C2-123X01	C2-113X01	C2-513X01				
M 3	0,50	56	10	5	18	3,5	2,7	2,50	0030	●	●	●					
M 3,5	0,60	56	12	6	20	4,0	3,0	2,90	0035	●	●	●					
M 4	0,70	63	12	7	21	4,5	3,4	3,30	0040	●	●	●					
M 4,5	0,75	70	14	7,5	25	6,0	4,9	3,80	0045	●	●	●					
M 5	0,80	70	14	8	25	6,0	4,9	4,20	0050	●	●	●					
M 6	1,00	80	18	10	30	6,0	4,9	5,00	0060	●	●	●					
M 7	1,00	80	18	10	30	7,0	5,5	6,00	0070	●	●	●					
M 8	1,25	90	20	13	35	8,0	6,2	6,80	0080	●	●	●					
M 9	1,25	90	20	13	35	9,0	7,0	7,80	0090	●	●	●					
M10	1,50	100	20	15	39	10,0	8,0	8,50	0100	●	●	●					
										ISO	Vc (m/min)						
										P	5-35	5-35	5-35				
										M	5-15	5-15	5-15				
										K	5-25	5-25	10-25				
										N	10-30	10-30	10-30				
										S	-	-	-				

Основная метрическая резьба ISO DIN-13



HSSE

TN2

DIN 376

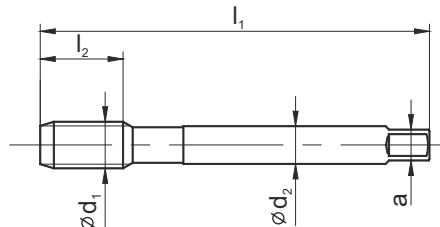

800X

C-TN2

B-TN2

C-R40-TN2



Обрабатываемые материалы

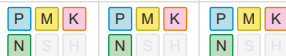

Тип отверстия

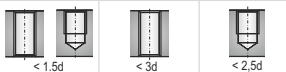

Изготовлен из

HSSE

HSSE

HSSE

Покрытие

TN2

TN2

TN2

Сбег резьбы

C / 2-3P

B / 4-5P

C / 2-3P

M d ₁	P	l ₁	l ₂	l ₂ R40	l ₃	d ₂	a		норма	DIN-376		
									Точность	ISO2 (6H)	ISO2 (6H)	ISO2 (6H)
									INDEX	D2-123X01	D2-113X01	D2-513X01
M3	0,50	56	11	5	-	2,2	1,8	2,50	0030	○	○	○
M4	0,70	63	12	8	-	2,8	2,1	3,30	0040	●	●	●
M5	0,80	70	14	10	-	3,5	2,7	4,20	0050	●	●	●
M6	1,00	80	18	12	-	4,5	3,4	5,00	0060	●	●	●
M8	1,25	90	20	15	-	6,0	4,9	6,80	0080	●	●	●
M10	1,50	100	20	17	-	7,0	5,5	8,50	0100	●	●	●
M12	1,75	110	24	18	-	9,0	7,0	10,20	0120	●	●	●
M14	2,00	110	25	20	-	11,0	9,0	12,00	0140	●	●	●
M16	2,00	110	32	20	-	12,0	9,0	14,00	0160	●	●	●
M18	2,50	125	32	25	-	14,0	11,0	15,50	0180	●	●	●
M20	2,50	140	32	25	-	16,0	12,0	17,50	0200	●	●	●
M22	2,50	140	32	25	-	18,0	14,5	19,50	0220	●	●	●
M24	3,00	160	38	30	-	18,0	14,5	21,00	0240	●	●	●
M27	3,00	160	38	30	-	20,0	16,0	24,00	0270	●	●	●
M30	3,50	180	40	35	-	22,0	18,0	26,50	0300	●	●	●
M33	3,50	180	45	35	-	25,0	20,0	29,50	0330	●	●	●
M36	4,00	200	50	40	-	28,0	22,0	32,00	0360	●	●	●
M39	4,00	200	55	40	-	32,0	24,0	35,00	0390	●	●	●
M42	4,50	200	60	45	-	32,0	24,0	37,50	0420	●	●	●
M45	4,50	220	60	45	-	36,0	29,0	40,50	0450	○	○	○
M48	5,00	250	65	50	-	36,0	29,0	43,00	0480	○	○	○
M52	5,00	250	65	50	-	40,0	32,0	47,00	0520	○	○	○

ISO	Vc (m/min)		
P	5-35	5-35	5-35
M	5-15	5-15	5-15
K	5-25	5-25	10-25
N	10-30	10-30	10-30
S	-	-	-

Пример заказа

D2-123X01-0390
800X M39-6H DIN-376 C HSSE TN2● Доступно со склада
○ По запросу



Основная метрическая резьба ISO DIN-13										800									
										C	C-LH	B	B-LH	B	B				
Обрабатываемые материалы																			
Тип отверстия																			
Изготовлен из										HSSE		HSSE		HSSE		HSSE			
Покрытие																			
Сбег резьбы										C / 2-3P		C / 2-3P		B / 4-5P		B / 4-5P			
M d ₁	P	l ₁	l ₂	l ₂ R40	l ₃	d ₂	a		норма	DIN-371									
										Точность	ISO1(4H)		ISO1(4H)						
										INDEX	C4-121102		C4-111102						
M1	0,25	40	6	-	13	2,5	2,1	0,75	0010	●		●							
M1,1	0,25	40	6	-	13	2,5	2,1	0,85	0011	●		●							
M1,2	0,25	40	6	-	13	2,5	2,1	0,95	0012	●		●							
M1,4	0,30	40	7	-	13	2,5	2,1	1,10	0014	●		●							
M d ₁	P	l ₁	l ₂	l ₂ R40	l ₃	d ₂	a		норма	DIN-371									
										Точность	ISO2 (6H)		ISO2 (6H)						
										INDEX	C4-121101		C4-111101						
M1,6	0,35	40	8	-	13	2,5	2,1	1,25	0016	●		●							
M1,7	0,35	40	8	-	13	2,5	2,1	1,35	0017	●		●							
M1,8	0,35	40	8	-	13	2,5	2,1	1,45	0018	●		●							
M2	0,40	45	10	-	13	2,8	2,1	1,60	0020	●		●							
M2,2	0,45	45	10	-	13	2,8	2,1	1,75	0022	●		●							
M2,3	0,40	45	10	-	13	2,8	2,1	1,90	0023	●		●							
M2,5	0,45	50	9	-	14	2,8	2,1	2,05	0025	●		●							
M2,6	0,45	50	9	-	14	2,8	2,1	2,15	0026	●		●							
M d ₁	P	l ₁	l ₂	l ₂ R40	l ₃	d ₂	a		норма	DIN-371									
										Точность	ISO2 (6H)	ISO2 (6H)	ISO2 (6H)	ISO2 (6H)	ISO3 (6G)	7G			
										INDEX	C2-121101	C2-221101	C2-111101	C2-211101	C2-111103	C2-111104			
M3	0,50	56	10	-	18	3,5	2,7	2,50	0030	●	●	●	●	●	○				
M3,5	0,60	56	12	-	20	4,0	3,0	2,90	0035	●	○	●	○	○	○				
M4	0,70	63	12	-	21	4,5	3,4	3,30	0040	●	●	●	●	●	○				
M4,5	0,75	70	14	-	25	6,0	4,9	3,80	0045	●	○	●	○	○	○				
M5	0,80	70	14	-	25	6,0	4,9	4,20	0050	●	●	●	●	●	○				
M6	1,00	80	18	-	30	6,0	4,9	5,00	0060	●	●	●	●	●	○				
M7	1,00	80	18	-	30	7,0	5,5	6,00	0070	●	○	●	○	○	○				
M8	1,25	90	20	-	35	8,0	6,2	6,80	0080	●	●	●	●	●	○				
M9	1,25	90	20	-	35	9,0	7,0	7,80	0090	●	○	●	○	○	○				
M10	1,50	100	20	-	39	10,0	8,0	8,50	0100	●	●	●	●	●	○				
										ISO	Vc (m/min)								
										P	5-20	5-20	5-20	5-20	5-20	5-20			
										M	-	-	-	-	-	-			
										K	5-15	5-15	5-15	5-15	5-15	5-15			
										N	5-25	5-25	5-25	5-25	5-25	5-25			
										S	-	-	-	-	-	-			

- Доступно со склада
- По запросу

Пример заказа
C4-121101-0100
800 M10-6H DIN-371 C HSSE

Основная метрическая резьба ISO DIN-13



HSSE

DIN 376

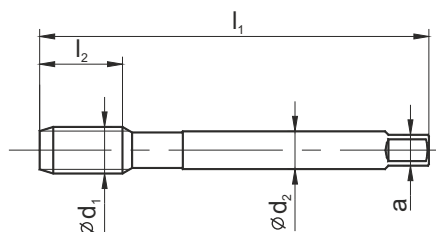

800

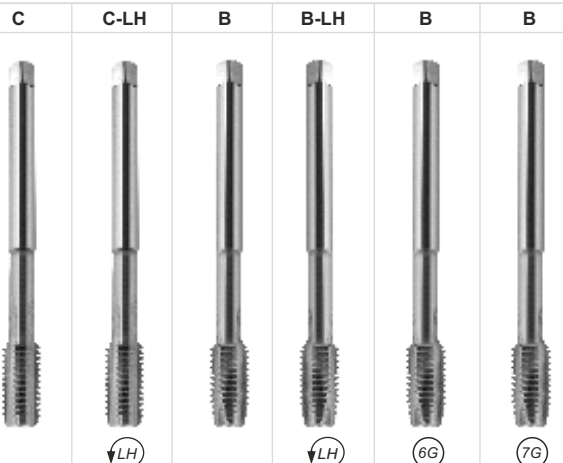

Обрабатываемые материалы



Тип отверстия



Изготовлен из

HSSE HSSE HSSE HSSE HSSE HSSE

Покрытие

Сбег резьбы

C / 2-3P C / 2-3P B / 4-5P B / 4-5P B / 4-5P B / 4-5P

M d ₁	P	l ₁	l ₂	l ₂ R40	l ₃	d ₂	a		норма	DIN-376						
										Точность	ISO2 (6H)	ISO2 (6H)	ISO2 (6H)	ISO2 (6H)	ISO3 (6G)	7G
											INDEX	D2-121101	D2-221101	D2-111101	D2-211101	D2-111103
M3	0,50	56	11	-	-	2,2	1,8	2,50	0030	●	○	●	○	○	○	
M4	0,70	63	12	-	-	2,8	2,1	3,30	0040	●	○	●	○	○	○	
M5	0,80	70	14	-	-	3,5	2,7	4,20	0050	●	○	●	○	○	○	
M6	1,00	80	18	-	-	4,5	3,4	5,00	0060	●	○	●	○	○	○	
M8	1,25	90	20	-	-	6,0	4,9	6,80	0080	●	○	●	○	○	○	
M10	1,50	100	20	-	-	7,0	5,5	8,50	0100	●	○	●	○	○	○	
M12	1,75	110	24	-	-	9,0	7,0	10,20	0120	●	●	●	●	●	○	
M14	2,00	110	25	-	-	11,0	9,0	12,00	0140	●	○	●	○	○	○	
M16	2,00	110	32	-	-	12,0	9,0	14,00	0160	●	●	●	●	●	○	
M18	2,50	125	32	-	-	14,0	11,0	15,50	0180	●	○	●	○	○	○	
M20	2,50	140	32	-	-	16,0	12,0	17,50	0200	●	●	●	●	●	○	
M22	2,50	140	32	-	-	18,0	14,5	19,50	0220	●	○	●	○	○	○	
M24	3,00	160	38	-	-	18,0	14,5	21,00	0240	●	●	●	●	○	○	
M27	3,00	160	38	-	-	20,0	16,0	24,00	0270	●	○	●	○	○	○	
M30	3,50	180	40	-	-	22,0	18,0	26,50	0300	●	○	●	○	○	○	
M33	3,50	180	45	-	-	25,0	20,0	29,50	0330	●	○	●	○	○	○	
M36	4,00	200	50	-	-	28,0	22,0	32,00	0360	●	○	●	○	○	○	
M39	4,00	200	55	-	-	32,0	24,0	35,00	0390	●	○	●	○	○	○	
M42	4,50	200	60	-	-	32,0	24,0	37,50	0420	●	○	●	○	○	○	
M45	4,50	220	60	-	-	36,0	29,0	40,50	0450	●	○	●	○	○	○	
M48	5,00	250	65	-	-	36,0	29,0	43,00	0480	●	○	●	○	○	○	
M52	5,00	250	65	-	-	40,0	32,0	47,00	0520	●	○	●	○	○	○	

ISO	V _c (m/min)					
P	5-35	5-20	5-20	5-20	5-20	5-20
M	-	-	-	-	-	-
K	10-25	5-15	5-15	5-15	5-15	5-15
N	10-35	5-25	5-25	5-25	5-25	5-25
S	-	-	-	-	-	-

Пример заказа

D2-221101-0120
800 M12-6H DIN-376 C LH HSSE● Доступно со склада
○ По запросу



Основная метрическая резьба ISO DIN-13										800							
										C-R40	C-LH-L40	C-R40	C-R40				
Обрабатываемые материалы																	
Тип отверстия																	
Изготовлен из										HSSE							
Покрытие																	
Сбег резьбы										C / 2-3P							
M d ₁	P	l ₁	l ₂	l ₂ R40	l ₃	d ₂	a		норма	DIN-371							
									Точность	ISO1(4H)							
									INDEX	C4-511102							
M1	0,25	40	-	6	13	2,5	2,1	0,75	0010	●							
M1,1	0,25	40	-	6	13	2,5	2,1	0,85	0011	●							
M1,2	0,25	40	-	6	13	2,5	2,1	0,95	0012	●							
M1,4	0,30	40	-	8	13	2,5	2,1	1,10	0014	●							
M d ₁	P	l ₁	l ₂	l ₂ R40	l ₃	d ₂	a		норма	DIN-371							
									Точность	ISO2 (6H)							
									INDEX	C4-511101							
M1,6	0,35	40	-	8	13	2,5	2,1	1,25	0016	●							
M1,7	0,35	40	-	8	13	2,5	2,1	1,35	0017	●							
M1,8	0,35	40	-	8	13	2,5	2,1	1,45	0018	●							
M2	0,40	45	-	10	13	2,8	2,1	1,60	0020	●							
M2,2	0,45	45	-	10	13	2,8	2,1	1,75	0022	●							
M2,3	0,40	45	-	10	13	2,8	2,1	1,90	0023	●							
M2,5	0,45	50	-	5	14	2,8	2,1	2,05	0025	●							
M2,6	0,45	50	-	5	14	2,8	2,1	2,15	0026	●							
M d ₁	P	l ₁	l ₂	l ₂ R40	l ₃	d ₂	a		норма	DIN-371		DIN-371					
									Точность	C2-511101	C2-591101	C2-511103	C2-511104				
									INDEX	ISO2 (6H)	ISO2 (6H)	ISO3 (6G)	7G				
M3	0,50	56	-	5	18	3,5	2,7	2,50	0030	●	●	●	○				
M3,5	0,60	56	-	6	20	4,0	3,0	2,90	0035	●	○	○	○				
M4	0,70	63	-	7	21	4,5	3,4	3,30	0040	●	●	●	○				
M4,5	0,75	70	-	7,5	25	6,0	4,9	3,80	0045	●	○	○	○				
M5	0,80	70	-	8	25	6,0	4,9	4,20	0050	●	●	●	○				
M6	1,00	80	-	10	30	6,0	4,9	5,00	0060	●	●	●	○				
M7	1,00	80	-	10	30	7,0	5,5	6,00	0070	●	○	○	○				
M8	1,25	90	-	13	35	8,0	6,2	6,80	0080	●	●	●	○				
M9	1,25	90	-	13	35	9,0	7,0	7,80	0090	●	○	○	○				
M10	1,50	100	-	15	39	10,0	8,0	8,50	0100	●	●	●	○				
● Доступно со склада ○ По запросу										ISO Vc (m/min)							
P										5-20	5-20	5-20	5-20				
M										-	-	-	-				
K										5-15	5-15	5-15	5-15				
N										5-25	5-25	5-25	5-25				
S										-	-	-	-				

Основная метрическая резьба ISO DIN-13										800								
										C-R40	C-LH-L40	C-R40	C-R40					
Обрабатываемые материалы																		
Тип отверстия																		
Изготовлен из										HSSE	HSSE	HSSE	HSSE					
Покрытие																		
Сбег резьбы										C / 2-3P	C / 2-3P	C / 2-3P	C / 2-3P					
M d ₁	P	l ₁	l ₂	l ₂ R40	l ₃	d ₂	a		норма	DIN-376								
										Точность	ISO2 (6H)	ISO2 (6H)	ISO3 (6G)	7G				
										INDEX	D2-511101	D2-591101	D2-511103	D2-511104				
M3	0,50	56	-	5	-	2,2	1,8	2,50	0030	●	○	○	○					
M4	0,70	63	-	8	-	2,8	2,1	3,30	0040	●	○	○	○					
M5	0,80	70	-	10	-	3,5	2,7	4,20	0050	●	○	○	○					
M6	1,00	80	-	12	-	4,5	3,4	5,00	0060	●	○	○	○					
M8	1,25	90	-	15	-	6,0	4,9	6,80	0080	●	○	○	○					
M10	1,50	100	-	17	-	7,0	5,5	8,50	0100	●	○	○	○					
M12	1,75	110	-	18	-	9,0	7,0	10,20	0120	●	●	●	○					
M14	2,00	110	-	20	-	11,0	9,0	12,00	0140	●	○	○	○					
M16	2,00	110	-	20	-	12,0	9,0	14,00	0160	●	●	●	○					
M18	2,50	125	-	25	-	14,0	11,0	15,50	0180	●	○	○	○					
M20	2,50	140	-	25	-	16,0	12,0	17,50	0200	●	●	●	○					
M22	2,50	140	-	25	-	18,0	14,5	19,50	0220	●	○	○	○					
M24	3,00	160	-	30	-	18,0	14,5	21,00	0240	●	●	○	○					
M27	3,00	160	-	30	-	20,0	16,0	24,00	0270	●	○	○	○					
M30	3,50	180	-	35	-	22,0	18,0	26,50	0300	●	○	○	○					
M33	3,50	180	-	35	-	25,0	20,0	29,50	0330	●	○	○	○					
M36	4,00	200	-	40	-	28,0	22,0	32,00	0360	●	○	○	○					
M39	4,00	200	-	40	-	32,0	24,0	35,00	0390	●	○	○	○					
M42	4,50	200	-	45	-	32,0	24,0	37,50	0420	●	○	○	○					
M45	4,50	220	-	45	-	36,0	29,0	40,50	0450	●	○	○	○					
M48	5,00	250	-	50	-	36,0	29,0	43,00	0480	●	○	○	○					
M52	5,00	250	-	50	-	40,0	32,0	47,00	0520	●	○	○	○					
										ISO	V _c (m/min)							
										P	5-20	5-20	5-20	5-20				
										M	-	-	-	-				
										K	5-15	5-15	5-15	5-15				
										N	5-25	5-25	5-25	5-25				
										S	-	-	-	-				



Основная метрическая резьба ISO DIN-13										800					
										B	C-R40				
Обрабатываемые материалы															
Тип отверстия															
Изготовлен из										HSSE					
Покрытие															
Сбег резьбы										B / 4-5P		C / 2-3P			
M d ₁	P	l ₁	l ₂	l ₂ R40	l ₃	d ₂	a		норма	DIN-371-EL					
									Точность	ISO2 (6H)	ISO2 (6H)				
									INDEX	C2-111121	C2-511121				
M3	0,50	100	10	5	18	3,5	2,7	2,50	0030	●	●				
M3,5	0,60	100	12	6	20	4,0	3,0	2,90	0035	○	○				
M4	0,70	125	12	7	21	4,5	3,4	3,30	0040	●	●				
M4,5	0,75	140	14	7,5	25	6,0	4,9	3,80	0045						
M5	0,80	140	14	8	25	6,0	4,9	4,20	0050	●	●				
M6	1,00	160	18	10	30	6,0	4,9	5,00	0060	●	●				
M d ₁	P	l ₁	l ₂	l ₂ R40	l ₃	d ₂	a		норма	DIN-376-EL					
									Точность						
									INDEX	D2-111121	D2-511121				
M8	1,25	180	20	15	-	6,0	4,9	6,80	0080	●	●				
M10	1,50	200	20	17	-	7,0	5,5	8,50	0100	●	●				
M12	1,75	220	24	18	-	9,0	7,0	10,20	0120	●	●				
M14	2,00	220	25	20	-	11,0	9,0	12,00	0140	○	○				
M16	2,00	220	32	20	-	12,0	9,0	14,00	0160	●	●				
M20	2,50	250	-	25	-	16,0	12,0	17,50	0200	○	○				
ISO										V _c (m/min)					
P										5-20	5-20				
M										-	-				
K										5-15	5-15				
N										5-25	5-25				
S										-	-				

Основная метрическая резьба ISO DIN-13										FAN-1200		1400				
										B-TC	C-R40-TC	C-TC	B-TC	C-R15-TC		
Обрабатываемые материалы																
Тип отверстия																
Изготовлен из										HSSE-PM		HSSE-PM		HSSE-PM		
Покрытие										TC		TC		TC		
Сбег резьбы										B / 4-5P		C / 2-3P		C / 2-3P		
M d ₁	P	l ₁	l ₂	l ₂ R40	l ₃	d ₂	a		норма	DIN-371						
										Точность	ISO2 (6H)	ISO2 (6H)	6HX	6HX	6HX	
										INDEX	C4-115001	C4-565001	C4-125901	C4-115901	C4-505901	
M 3	0,50	56	10	5	18	3,5	2,7	2,50	0030	●	●	●	●	●		
M 4	0,70	63	12	7	21	4,5	3,4	3,30	0040	●	●	●	●	●		
M 5	0,80	70	14	8	25	6,0	4,9	4,20	0050	●	●	●	●	●		
M 6	1,00	80	18	10	30	6,0	4,9	5,00	0060	●	●	●	●	●		
M 8	1,25	90	20	13	35	8,0	6,2	6,80	0080	●	●	●	●	●		
M10	1,50	100	20	15	39	10,0	8,0	8,50	0100	●	●	●	●	●		

M d ₁	P	l ₁	l ₂	l ₂ R40	l ₃	d ₂	a		норма	DIN-376					
										Точность	ISO2 (6H)	ISO2 (6H)	6HX	6HX	6HX
										INDEX	D4-115001	D4-565001	D4-125901	D4-115901	D4-505901
M8	1,25	90	20	15	-	6,0	4,9	6,80	0080	●	●	●	●	●	
M10	1,50	100	20	17	-	7,0	5,5	8,50	0100	●	●	●	●	●	
M12	1,75	110	24	18	-	9,0	7,0	10,20	0120	●	●	●	●	●	
M14	2,00	110	25	20	-	11,0	9,0	12,00	0140	●	●	●	●	●	
M16	2,00	110	32	20	-	12,0	9,0	14,00	0160	●	●	●	●	●	
M18	2,50	125	32	25	-	14,0	11,0	15,50	0180	●	●	○	○	○	
M20	2,50	140	32	25	-	16,0	12,0	17,50	0200	●	●	●	●	●	
M22	2,50	140	32	25	-	18,0	14,5	19,50	0220	●	●	○	○	○	
M24	3,00	160	38	30	-	18,0	14,5	21,00	0240	●	●	●	●	●	
M27	3,00	160	38	30	-	20,0	16,0	24,00	0270	●	●	○	○	○	
M30	3,50	180	40	35	-	22,0	18,0	26,50	0300	●	●	○	○	○	
M33	3,50	180	45	35	-	25,0	20,0	29,50	0330	●	●	○	○	○	
M36	4,00	200	50	40	-	28,0	22,0	32,00	0360	●	●	○	○	○	

ISO	Vc (m/min)				
P	5-35	5-35	1-20	1-20	1-20
M	5-15	5-10	1-10	1-10	1-10
K	5-25	5-25	1-20	1-20	1-20
N	10-30	10-30	10-20	10-20	10-20
S	-	-	-	-	-

Основная метрическая резьба ISO DIN-13										INOX																																																																																																																																																					
										B	B-HL	C-R40	C-R40-HL																																																																																																																																																		
Обрабатываемые материалы										P M K N S H	P M K N S H	P M K N S H	P M K N S H																																																																																																																																																		
Тип отверстия																																																																																																																																																															
Изготовлен из										HSSE	HSSE	HSSE	HSSE																																																																																																																																																		
Покрытие											HL		HL																																																																																																																																																		
Сбег резьбы										B / 4-5P	B / 4-5P	C / 2-3P	C / 2-3P																																																																																																																																																		
<table border="1"> <thead> <tr> <th rowspan="2">M d_i</th> <th rowspan="2">P</th> <th rowspan="2">l₁</th> <th rowspan="2">l₂</th> <th rowspan="2">l₂ R40</th> <th rowspan="2">l₃</th> <th rowspan="2">d₂</th> <th rowspan="2">a</th> <th rowspan="2"></th> <th colspan="4">DIN-371</th> <th colspan="3"></th> </tr> <tr> <th>Точность</th> <th>ISO2 (6H)</th> <th>ISO2 (6H)</th> <th>ISO2 (6H)</th> <th>ISO2 (6H)</th> <th></th> <th></th> <th></th> </tr> <tr> <th colspan="10"></th> <th>INDEX</th> <th>C2-111801</th> <th>C2-118801</th> <th>C2-511801</th> <th>C2-518801</th> <th></th> <th></th> <th></th> </tr> </thead> <tbody> <tr> <td>M3</td> <td>0,50</td> <td>56</td> <td>10</td> <td>5</td> <td>18</td> <td>3,5</td> <td>2,7</td> <td>2,50</td> <td>0030</td> <td>●</td> <td>●</td> <td>●</td> <td>●</td> <td></td> <td></td> <td></td> </tr> <tr> <td>M4</td> <td>0,70</td> <td>63</td> <td>12</td> <td>7</td> <td>21</td> <td>4,5</td> <td>3,4</td> <td>3,30</td> <td>0040</td> <td>●</td> <td>●</td> <td>●</td> <td>●</td> <td></td> <td></td> <td></td> </tr> <tr> <td>M5</td> <td>0,80</td> <td>70</td> <td>14</td> <td>8</td> <td>25</td> <td>6,0</td> <td>4,9</td> <td>4,20</td> <td>0050</td> <td>●</td> <td>●</td> <td>●</td> <td>●</td> <td></td> <td></td> <td></td> </tr> <tr> <td>M6</td> <td>1,00</td> <td>80</td> <td>18</td> <td>10</td> <td>30</td> <td>6,0</td> <td>4,9</td> <td>5,00</td> <td>0060</td> <td>●</td> <td>●</td> <td>●</td> <td>●</td> <td></td> <td></td> <td></td> </tr> <tr> <td>M8</td> <td>1,25</td> <td>90</td> <td>20</td> <td>13</td> <td>35</td> <td>8,0</td> <td>6,2</td> <td>6,80</td> <td>0080</td> <td>●</td> <td>●</td> <td>●</td> <td>●</td> <td></td> <td></td> <td></td> </tr> <tr> <td>M10</td> <td>1,50</td> <td>100</td> <td>20</td> <td>15</td> <td>39</td> <td>10,0</td> <td>8,0</td> <td>8,50</td> <td>0100</td> <td>●</td> <td>●</td> <td>●</td> <td>●</td> <td></td> <td></td> <td></td> </tr> </tbody> </table>										M d _i	P	l ₁	l ₂	l ₂ R40	l ₃	d ₂	a		DIN-371							Точность	ISO2 (6H)	ISO2 (6H)	ISO2 (6H)	ISO2 (6H)														INDEX	C2-111801	C2-118801	C2-511801	C2-518801				M3	0,50	56	10	5	18	3,5	2,7	2,50	0030	●	●	●	●				M4	0,70	63	12	7	21	4,5	3,4	3,30	0040	●	●	●	●				M5	0,80	70	14	8	25	6,0	4,9	4,20	0050	●	●	●	●				M6	1,00	80	18	10	30	6,0	4,9	5,00	0060	●	●	●	●				M8	1,25	90	20	13	35	8,0	6,2	6,80	0080	●	●	●	●				M10	1,50	100	20	15	39	10,0	8,0	8,50	0100	●	●	●	●									
																			M d _i	P	l ₁	l ₂	l ₂ R40	l ₃	d ₂	a		DIN-371																																																																																																																																			
Точность	ISO2 (6H)	ISO2 (6H)	ISO2 (6H)	ISO2 (6H)																																																																																																																																																											
										INDEX	C2-111801	C2-118801	C2-511801	C2-518801																																																																																																																																																	
M3	0,50	56	10	5	18	3,5	2,7	2,50	0030	●	●	●	●																																																																																																																																																		
M4	0,70	63	12	7	21	4,5	3,4	3,30	0040	●	●	●	●																																																																																																																																																		
M5	0,80	70	14	8	25	6,0	4,9	4,20	0050	●	●	●	●																																																																																																																																																		
M6	1,00	80	18	10	30	6,0	4,9	5,00	0060	●	●	●	●																																																																																																																																																		
M8	1,25	90	20	13	35	8,0	6,2	6,80	0080	●	●	●	●																																																																																																																																																		
M10	1,50	100	20	15	39	10,0	8,0	8,50	0100	●	●	●	●																																																																																																																																																		
										ISO	V _c (m/min)																																																																																																																																																				
										P	-	-	-	-																																																																																																																																																	
										M	5-15	5-15	5-15	5-15																																																																																																																																																	
										K	-	-	-	-																																																																																																																																																	
										N	-	-	-	-																																																																																																																																																	
										S	-	-	-	-																																																																																																																																																	

Основная метрическая резьба ISO DIN-13

INOX



HSSE

HL

DIN 376

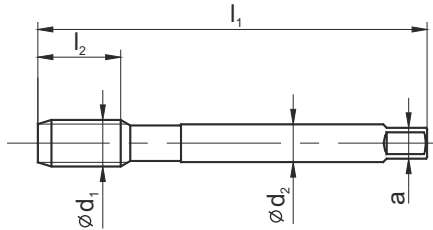

Обрабатываемые материалы



Тип отверстия



Изготовлен из

HSSE HSSE HSSE HSSE

Покрытие

- HL - HL

Сбег резьбы

B / 4-5P B / 4-5P C / 2-3P C / 2-3P

M d ₁	P	l ₁	l ₂	l _{R40}	l ₃	d ₂	a		DIN-376							
									норма							
									Точность	ISO2 (6H)	ISO2 (6H)	ISO2 (6H)	ISO2 (6H)			
									INDEX	D2-111801	D2-118801	D2-511801	D2-518801			
M8	1,25	90	20	15	-	6,0	4,9	6,80	0080	●	●	●	●			
M10	1,50	100	20	17	-	7,0	5,5	8,50	0100	●	●	●	●			
M12	1,75	110	24	18	-	9,0	7,0	10,20	0120	●	●	●	●			
M14	2,00	110	25	20	-	11,0	9,0	12,00	0140	●	●	●	●			
M16	2,00	110	32	20	-	12,0	9,0	14,00	0160	●	●	●	●			
M18	2,50	125	32	25	-	14,0	11,0	15,50	0180	●	●	●	●			
M20	2,50	140	32	25	-	16,0	12,0	17,50	0200	●	●	●	●			
M22	2,50	140	32	25	-	18,0	14,5	19,50	0220	●	●	●	●			
M24	3,00	160	38	30	-	18,0	14,5	21,00	0240	●	●	●	●			
M27	3,00	160	38	30	-	20,0	16,0	24,00	0270	●	○	●	○			
M30	3,50	180	40	35	-	22,0	18,0	26,50	0300	●	○	●	○			
M33	3,50	180	45	35	-	25,0	20,0	29,50	0330	●	○	●	○			
M36	4,00	200	50	40	-	28,0	22,0	32,00	0360	●	○	●	○			

ISO	V _c (m/min)			
P	-	-	-	-
M	5-15	5-15	5-15	5-15
K	-	-	-	-
N	-	-	-	-
S	-	-	-	-

Пример заказа

D2-111801-0080
INOX M8-6H DIN-376 B HSSE● Доступно со склада
○ По запросу



Основная метрическая резьба ISO DIN-13									GG					GAL						
									C-TC	C-IK-TC	E-TC	E-IK-TC	E-IKR-TC	C-R15-TC	E-R15-IK-TC					
Обрабатываемые материалы									P M K		P M K		P M K		P M K		P M K		P M K	
Тип отверстия																				
Изготовлен из									HSSE-PM		HSSE-PM		HSSE-PM		HSSE-PM		HSSE-PM		HSSE-PM	
Покрытие									TC		TC		TC		TC		TC		TC	
Сбег резьбы									C / 2-3P		C / 2-3P		E / 1,5-2P		E / 1,5-2P		C / 2-3P		E / 1,5-2P	
M d ₁	P	l ₁	l ₂	l ₃	d ₂	a		норма	DIN-371											
									Точность	6HX	6HX	6HX	6HX	6HX	6HX	6HX				
									INDEX	C2-125501	C4-125551	C2-145501	C4-145551	C4-145561	C2-505601	C4-655651				
M 3	0,50	56	10	18	3,5	2,7	2,50	0030	●	-	○	-	-	●	-					
M 4	0,70	63	12	21	4,5	3,4	3,30	0040	●	-	●	-	-	●	-					
M 5	0,80	70	14	25	6,0	4,9	4,20	0050	●	●	●	●	●	●	○					
M 6	1,00	80	18	30	6,0	4,9	5,00	0060	●	●	●	●	●	●	○					
M 7	1,00	80	18	30	7,0	5,5	6,00	0070	○	○	○	○	○	○	○					
M 8	1,25	90	20	35	8,0	6,2	6,80	0080	●	●	●	●	●	●	○					
M 9	1,25	90	20	35	9,0	7,0	7,80	0090	○	○	○	○	○	○	○					
M10	1,50	100	20	39	10,0	8,0	8,50	0100	●	●	●	●	●	●	○					

M d ₁	P	l ₁	l ₂	l ₃	d ₂	a		норма	DIN-376							
									Точность	6HX	6HX	6HX	6HX	6HX	6HX	6HX
									INDEX	D2-125501	D4-125551	D2-145501	D4-145551	D4-145561	D2-505601	D4-655651
M6	1,00	80	18	-	4,5	3,4	5,00	0060	●	○	●	○	○	●	○	
M8	1,25	90	20	-	6,0	4,9	6,80	0080	●	●	●	●	○	●	○	
M10	1,50	100	20	-	7,0	5,5	8,50	0100	●	●	●	●	○	●	○	
M12	1,75	110	24	-	9,0	7,0	10,20	0120	●	●	●	●	●	●	●	
M14	2,00	110	25	-	11,0	9,0	12,00	0140	●	○	○	○	○	●	○	
M16	2,00	110	32	-	12,0	9,0	14,00	0160	●	●	○	●	●	●	●	
M18	2,50	125	32	-	14,0	11,0	15,50	0180	●	○	○	○	○	●	○	
M20	2,50	140	32	-	16,0	12,0	17,50	0200	●	○	○	○	○	●	○	

ISO	V _c (m/min)						
P	-	-	-	-	-	-	-
M	-	-	-	-	-	-	-
K	1-60	5-60	1-60	5-60	5-60	-	-
N	-	-	-	-	-	10-30	10-30
S	-	-	-	-	-	-	-

Основная метрическая резьба ISO DIN-13

HRC60

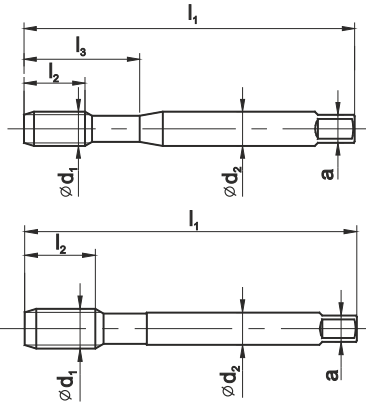

Обрабатываемые материалы

P M K	P M K	P M K	P M K
N S H	N S H	N S H	N S H

Тип отверстия

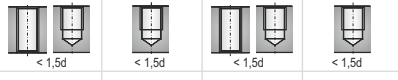

Изготовлен из

VHM VHM VHM VHM

Покрытие

TC TC TC TC

Сбег резьбы

C / 2-3P C / 2-3P D / 4-5P D / 4-5P

M d ₁	P	l ₁	l ₂	l ₃	d ₂	a		норма	DIN-371			
								Точность	6HX			
								INDEX	C9-125F01	C9-125F51	C9-135F01	C9-135F51
M3	0,50	56	5	18	3,5	2,7	2,50	0030	●	-	●	-
M4	0,70	63	7	21	4,5	3,4	3,30	0040	●	-	●	-
M5	0,80	70	8	25	6,0	4,9	4,20	0050	●	-	●	-
M6	1,00	80	10	30	6,0	4,9	5,00	0060	●	●	●	●
M8	1,25	90	13	35	8,0	6,2	6,80	0080	●	●	●	●
M10	1,50	100	15	39	10,0	8,0	8,50	0100	●	●	●	●

M d ₁	P	l ₁	l ₂	l ₃	d ₂	a		норма	DIN-376			
								Точность	6HX			
								INDEX	D9-125F01	D9-125F51	D9-135F01	D9-135F51
M12	1,75	110	18	-	9,0	7,0	10,20	0120	●	●	●	●
M14	2,00	110	20	-	11,0	9,0	12,00	0140	●	●	●	●
M16	2,00	110	20	-	12,0	9,0	14,00	0160	●	●	●	●

ISO	Vc (m/min)			
P	-	-	-	-
M	-	-	-	-
K	-	-	-	-
N	-	-	-	-
S	-	-	-	-
H	1-4	1-4	1-4	1-4

Основная метрическая резьба ISO DIN-13										S-NC							
										B-TC	C-R45-TC	C-R45-IK-TC					
Тип отверстия																	
Изготовлен из										HSSE-PM							
Покрытие										TC							
Сбег резьбы										B / 4-5P							
										DIN-371							
M	P	l ₁	l ₂	l ₃	d ₂	a		норма	DIN-371								
d ₁								Точность	6HX	6HX	6HX						
								INDEX	C4-115301	C4-525301	C4-525351						
M3	0,50	56	5	18	3,5	2,7	2,50	0030	●	●	-						
M4	0,70	63	7	21	4,5	3,4	3,30	0040	●	●	-						
M5	0,80	70	8	25	6,0	4,9	4,20	0050	●	●	●						
M6	1,00	80	10	30	6,0	4,9	5,00	0060	●	●	●						
M8	1,25	90	13	35	8,0	6,2	6,80	0080	●	●	●						
M10	1,50	100	15	39	10,0	8,0	8,50	0100	●	●	●						
										DIN-376							
M	P	l ₁	l ₂	l ₃	d ₂	a		норма	DIN-376								
d ₁								Точность	6HX	6HX	6HX						
								INDEX	D4-115301	D4-525301	D4-525351						
M12	1,75	110	18	-	9,0	7,0	10,20	0120	●	●	●						
M14	2,00	110	20	-	11,0	9,0	12,00	0140	●	●	●						
M16	2,00	110	20	-	12,0	9,0	14,00	0160	●	●	●						
										V _c (m/min)							
										P	5-50	5-50	5-60				
										M	5-20	5-20	5-30				
										K	10-40	10-40	10-60				
										N	10-40	10-40	10-60				
										S	1-8	1-8	1-8				

Основная метрическая резьба ISO DIN-13

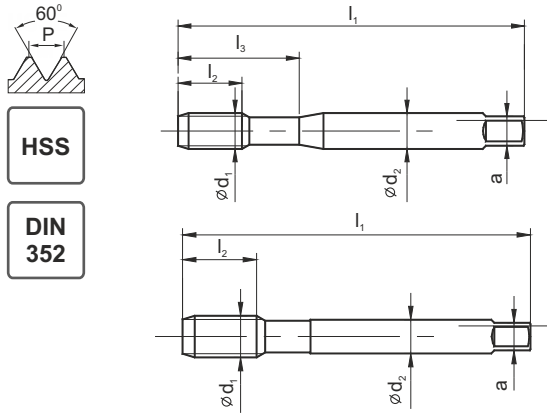

HSS

DIN 352



LH

LH

Обрабатываемые материалы



Тип отверстия

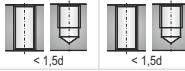

Изготовлен из

HSS HSS

Покрытие

Сбег резьбы

~3P ~3P

M d ₁	P	l ₁	l ₂	l ₃	d ₂	a		норма						
								DIN-352						
								Точность	ISO2 (6H)	ISO2 (6H)				
INDEX	E1-131001	E1-231001												
M3	0,50	40	11	18,0	3,5	2,7	2,5	0030	●	○				
M3,5	0,60	45	13	21,0	4,0	3,0	2,9	0035	●	○				
M4	0,70	45	13	21,0	4,5	3,4	3,3	0040	●	○				
M4,5	0,75	50	16	25,0	6,0	4,9	3,7	0045	○	○				
M5	0,80	52	16	26,0	6,0	4,9	4,2	0050	●	○				
M6	1,00	56	18	27,0	6,0	4,9	5,0	0060	●	○				
M7	1,00	56	18	-	6,0	4,9	6,0	0070	○	○				
M8	1,25	63	20	-	6,0	4,9	6,8	0080	●	○				
M9	1,25	63	20	-	7,0	5,5	7,8	0090	○	○				
M10	1,50	70	22	-	7,0	5,5	8,5	0100	●	○				
M11	1,50	70	22	-	8,0	6,2	9,5	0110	○	○				
M12	1,75	80	24	-	9,0	7,0	10,2	0120	●	○				
M14	2,00	80	26	-	11,0	9,0	12,0	0140	●	○				
M16	2,00	80	27	-	12,0	9,0	14,0	0160	●	○				
M18	2,50	95	30	-	14,0	11,0	15,5	0180	●	○				
M20	2,50	95	32	-	16,0	12,0	17,5	0200	●	○				
M22	2,50	100	32	-	18,0	14,5	19,5	0220	●	○				
M24	3,00	110	34	-	18,0	14,5	21,0	0240	●	○				
M27	3,00	110	36	-	20,0	16,0	24,0	0270	●	○				
M30	3,50	125	40	-	22,0	18,0	26,5	0300	●	○				
M33	3,50	125	40	-	25,0	20,0	29,5	0330	○	○				
M36	4,00	150	50	-	28,0	22,0	32,0	0360	●	○				
M39	4,00	150	50	-	32,0	24,0	35,0	0390	○	○				
M42	4,50	150	56	-	32,0	24,0	37,5	0420	●	○				
M45	4,50	160	58	-	36,0	29,0	40,5	0450	○	○				
M48	5,00	180	65	-	36,0	29,0	43,0	0480	○	○				
M52	5,00	180	65	-	40,0	32,0	47,0	0520	○	○				
M56	5,50	180	70	-	40,0	32,0	50,5	0560	○	○				
M60	5,50	200	70	-	45,0	35,0	54,5	0600	○	○				
M64	6,00	220	75	-	50,0	39,0	58,0	0640	○	○				
M68	6,00	220	75	-	50,0	39,0	62,0	0680	○	○				

- Доступно со склада
- По запросу

ISO	V _c (m/min)						
P	5-20	5-20					
M	-	-					
K	-	-					
N	-	-					
S	-	-					

Пример заказа
E1-131001-0060
M6-6H DIN-352 HSS

Основная метрическая резьба ISO DIN-13					NUT-TAP				
					soldered	torsioned			
Обрабатываемые материалы									
Тип отверстия									
Изготовлен из					HSSE				
Покрытие					TC				
Сбег резьбы					12P				
M	P	Габаритные размеры		норма	NUT-TAP				
d_1				INDEX	Под заказ				
M12	1,75	Под заказ	10,2	0030	○	○			
M14	2,00		12,0	0035	○	○			
M16	2,00		14,0	0040	○	○			
M18	2,50		15,5	0045	○	○			
M20	2,50		17,5	0050	○	○			
M22	2,50		19,5	0060	○	○			
M24	3,00		21,0	0070	○	○			
M27	3,00		24,0	0080	○	○			
M30	3,50		26,5	0090	○	○			
M33	3,50		29,5	0100	○	○			
M36	4,00		32,0	0110	○	○			
ISO	Vc (m/min)								
P	5-20	5-20							
M	-	-							
K	-	-							
N	-	-							
S	-	-							

1

Основная метрическая резьба ISO DIN-13



HSS

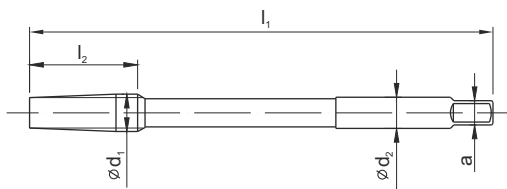

NGMf

LH



Обрабатываемые материалы



Тип отверстия



Изготовлен из

HSS HSS

Покрытие

Сбег резьбы

12P 12P

M d ₁	P	l ₁	l ₂	d ₂	a		норма	NGMf					
							Точность	ISO2 (6H)	ISO2 (6H)				
							INDEX	F1-151001	F1-251001				
M3	0,5	70	10	2,2	1,8	2,50	0030	○	○				
M4	0,70	90	14	2,8	2,2	3,30	0040	●	●				
M4,5	0,75	100	16	3,2	2,5	3,80	0045	○	○				
M5	0,80	110	16	3,5	2,8	4,20	0050	●	●				
M6	1,00	120	20	4,5	3,6	5,00	0060	●	●				
M7	1,00	120	20	5,6	4,5	6,00	0070	○	○				
M8	1,25	140	25	6,3	5,0	6,80	0080	●	●				
M10	1,50	160	30	8,0	6,3	8,50	0100	●	●				
M12	1,75	180	36	9,0	7,1	10,20	0120	●	●				
M14	2,00	180	40	10,0	8,0	12,00	0140	●	○				
M16	2,00	200	40	12,5	10,0	14,00	0160	●	●				
M18	2,50	200	50	14,0	11,2	15,50	0180	●	○				
M20	2,50	220	50	16,0	12,5	17,50	0200	●	●				
M22	2,50	220	50	18,0	14,0	19,50	0220	●	○				
M24	3,00	250	60	18,0	14,0	21,00	0240	●	●				
M27	3,00	250	60	20,0	16,0	24,00	0270	●	○				
M30	3,50	280	70	22,4	18,0	26,50	0300	●	●				
M33	3,50	280	70	25,0	20,0	29,50	0330	●	●				
M36	4,00	320	80	28,0	22,4	32,00	0360	●	●				

ISO	Vc (m/min)					
P	5-20	5-20				
M	-	-				
K	6-15	6-15				
N	6-15	6-15				
S	-	-				

Основная метрическая резьба ISO DIN-13									KOMBI							
									D-R30							
Обрабатываемые материалы									<table border="1"> <tr> <td>P</td> <td>M</td> <td>K</td> </tr> <tr> <td>N</td> <td>S</td> <td>H</td> </tr> </table>		P	M	K	N	S	H
P	M	K														
N	S	H														
Тип отверстия									 $< 1,5d$							
Изготовлен из									HSS							
Покрытие									-							
Сбег резьбы									D/4P							
M d ₁	P	l ₁	l ₂	l ₃	d ₂	a		норма	KOMBI							
								Точность	ISO2 (6H)							
								INDEX	G1-051001							
M 3	0,50	56	11	16	3	2,4	2,5	0030	●							
M 4	0,70	63	14	18	4	3,0	3,3	0040	●							
M 5	0,80	71	18	20	5	3,8	4,2	0050	●							
M 6	1,00	80	22	22	6	4,9	5,0	0060	●							
M 8	1,25	95	25	26	8	6,2	6,8	0080	●							
M 10	1,50	106	31	30	10	8,0	8,5	0100	●							
M 12	1,75	115	35	32	12	9,0	10,2	0120	●							

ISO	Vc (m/min)					
P	5-15					
M	-					
K	-					
N	6-15					
S	-					

1

Основная метрическая резьба ISO DIN-13

BIT



HSS

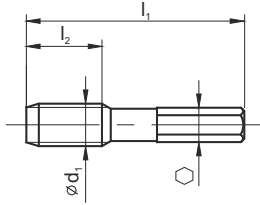

Обрабатываемые материалы



Тип отверстия



Изготовлен из

HSS

Покрытие

-

Сбег резьбы

D/4P

M d ₁	P	l ₁	l ₂	l ₃	d ₂	Hex	Diagram	норма	BIT	
									Точность	ISO2 (6H)
								INDEX	G1-031001	
M3	0,50	33	11	-	-	1/4"	2,5	0030	●	
M4	0,70	35	12	-	-	1/4"	3,3	0040	●	
M5	0,80	36	15	-	-	1/4"	4,2	0050	●	
M6	1,00	39	18	-	-	1/4"	5,0	0060	●	
M8	1,25	40	19	-	-	1/4"	6,8	0080	●	
M10	1,50	41	21	-	-	1/4"	8,5	0100	●	

ISO	Vc (m/min)				
P	5-15				
M	-				
K	-				
N	6-15				
S	-				

Бит набор страниц 119



Основная метрическая резьба ISO DIN-13										MASTER TAP											
										B-HL	B-IKR-HL	C-R45-HL	C-R45-IK-HL	E-R45-HL	E-R45-IK-HL						
Обрабатываемые материалы										P M K N S		P M K N S		P M K N S		P M K N S		P M K N S			
Тип отверстия																					
Изготовлен из										HSSE-PM		HSSE-PM		HSSE-PM		HSSE-PM		HSSE-PM			
Покрытие										HL		HL		HL		HL		HL			
Сбег резьбы										B / 4-5P		B / 4-5P		C / 2-3P		C / 2-3P		E / 1,5-2P			
MF d_1	P	l_1	l_2	l_3	d_2	a		Норма	DIN-371												
									Точность	6HX	6HX	6HX	6HX	6HX	6HX						
									INDEX	C4-118M01	C4-118M61	C4-528M01	C4-528M51	C4-718M01	C4-718M51						
M3x0,35	0,35	56	5	18	3,5	2,7	2,65	0031	●	-	●	-	○	-							
M3,5x0,35	0,35	56	5	20	4,0	3,0	3,15	0036	●	-	●	-	○	-							
M4x0,5	0,50	63	7	21	4,5	3,4	3,50	0041	●	-	●	-	○	-							
M5x0,5	0,50	70	8	25	6,0	4,9	4,50	0051	●	○	●	○	○	○							
M6x0,5	0,50	80	10	30	6,0	4,9	5,50	0061	●	○	●	○	○	○							
M6x0,75	0,75	80	10	30	6,0	4,9	5,20	0062	●	○	●	○	○	○							
M8x0,75	0,75	80	10	30	8,0	6,2	7,20	0082	●	○	●	○	○	○							
M8x1	1,00	90	13	35	8,0	6,2	7,00	0083	●	●	●	●	●	●							
M10x0,75	0,75	90	13	35	10,0	8,0	9,20	0102	●	○	●	○	○	○							
M10x1	1,00	90	13	35	10,0	8,0	9,00	0103	●	●	●	●	●	●							
M10x1,25	1,25	100	15	39	10,0	8,0	8,80	0104	●	○	●	○	○	○							
									Vc (m/min)												
									P	5-40	5-50	5-40	5-50	5-40	5-50						
									M	5-15	5-25	5-15	5-25	5-15	5-25						
									K	10-30	10-50	10-30	10-50	10-30	10-50						
									N	10-30	10-50	10-30	10-50	10-30	10-50						
									S	1-8	1-8	1-8	1-8	1-8	1-8						

1

Основная метрическая резьба ISO DIN-13

MASTER TAP



HSSE
PM

HL

DIN
374

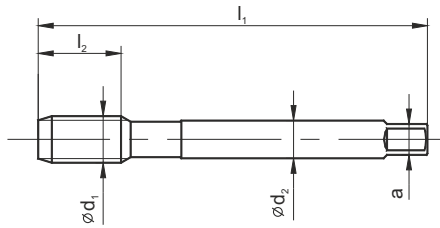

B-HL B-IKR-HL C-R45-HL C-R45-IK-HL E-R45-HL E-R45-IK-HL



Обрабатываемые материалы

P	M	K	P	M	K	P	M	K	P	M	K	P	M	K	P	M	K
N	S	H	N	S	H	N	S	H	N	S	H	N	S	H	N	S	H

Тип отверстия



Изготовлен из

HSSE-PM HSSE-PM HSSE-PM HSSE-PM HSSE-PM HSSE-PM

Покрытие

HL HL HL HL HL HL

Сбег резьбы

B / 4-5P B / 4-5P C / 2-3P C / 2-3P E / 1,5-2P E / 1,5-2P

MF d ₁	P	l ₁	l ₂	l ₃	d ₂	a		Норма	DIN-374						
									Точность	6HX	6HX	6HX	6HX	6HX	6HX
									INDEX	D4-118M01	D4-118M61	D4-528M01	D4-528M51	D4-718M01	D4-718M51
M8x1	1,00	90	10	-	6,0	4,9	7,00	0083	●	●	●	●	●	○	
M10x0,75	0,75	90	10	-	7,0	5,5	9,20	0102	○	○	○	○	○	○	
M10x1	1,00	90	10	-	7,0	5,5	9,00	0103	●	●	●	●	●	○	
M10x1,25	1,25	100	15	-	7,0	5,5	8,80	0104	○	○	○	○	○	○	
M12x1	1,00	100	10	-	9,0	7,0	11,00	0123	●	○	●	○	○	○	
M12x1,25	1,25	100	15	-	9,0	7,0	10,80	0124	●	○	●	○	○	○	
M12x1,5	1,50	100	15	-	9,0	7,0	10,50	0125	●	●	●	●	●	○	
M14x1	1,00	100	10	-	11,0	9,0	13,00	0143	○	○	○	○	○	○	
M14x1,25	1,25	100	15	-	11,0	9,0	12,80	0144	○	○	○	○	○	○	
M14x1,5	1,50	100	15	-	11,0	9,0	12,50	0145	●	●	●	●	●	○	
M15x1	1,00	100	10	-	12,0	9,0	14,00	0153	○	○	○	○	○	○	
M16x1	1,00	100	10	-	12,0	9,0	15,00	0163	○	○	○	○	○	○	
M16x1,5	1,50	100	15	-	12,0	9,0	14,50	0165	●	●	●	●	●	○	
M18x1	1,00	110	13	-	14,0	11,0	17,00	0183	○	○	○	○	○	○	
M18x1,5	1,50	110	17	-	14,0	11,0	16,50	0185	●	○	●	○	○	○	
M18x2	2,00	125	20	-	14,0	11,0	16,00	0186	○	○	○	○	○	○	
M20x1	1,00	125	13	-	16,0	12,0	19,00	0203	○	○	○	○	○	○	
M20x1,5	1,50	125	17	-	16,0	12,0	18,50	0205	●	○	●	○	○	○	
M20x2	2,00	140	20	-	16,0	12,0	18,00	0206	○	○	○	○	○	○	
M22x1	1,00	125	13	-	18,0	14,5	21,00	0223	○	○	○	○	○	○	
M22x1,5	1,50	125	17	-	18,0	14,5	20,50	0225	●	○	●	○	○	○	
M22x2	2,00	140	20	-	18,0	14,5	20,00	0226	○	○	○	○	○	○	
M24x1	1,00	140	13	-	18,0	14,5	23,00	0243	○	○	○	○	○	○	
M24x1,5	1,50	140	20	-	18,0	14,5	22,50	0245	●	○	●	○	○	○	
M24x2	2,00	140	20	-	18,0	14,5	22,00	0246	○	○	○	○	○	○	

ISO	Vc (m/min)					
P	5-40	5-50	5-40	5-50	5-40	5-50
M	5-15	5-25	5-15	5-25	5-15	5-25
K	10-30	10-50	10-30	10-50	10-30	10-50
N	10-30	10-50	10-30	10-50	10-30	10-50
S	1-8	1-8	1-8	1-8	1-8	1-8

MASTER TAP

Основная метрическая резьба ISO DIN-13										800X							
										C-TN2	B-TN2	C-R40-TN2					
Обрабатываемые материалы																	
Тип отверстия																	
Изготовлен из										HSSE	HSSE	HSSE					
Покрытие										TN2	TN2	TN2					
Сбег резьбы										C / 2-3P	B / 4-5P	C / 2-3P					
MF d_1	P	l_1	l_2	l_2 R40	l_3	d_2	a		Норма								
									DIN-371								
									Точность	ISO2 (6H)	ISO2 (6H)	ISO2 (6H)					
									INDEX	C2-123X01	C2-113X01	C2-513X01					
M4x0,5	0,50	63	12	7	21	4,5	3,4	3,50	0041	○	○	○					
M5x0,5	0,50	70	14	8	25	6,0	4,9	4,50	0051	○	○	○					
M6x0,75	0,75	80	14	10	30	6,0	4,9	5,20	0062	○	○	○					
M8x0,75	0,75	80	18	10	30	8,0	6,2	7,20	0082	○	○	○					
M8x1	1,00	90	20	13	35	8,0	6,2	7,00	0083	●	●	●					
M10x0,75	0,75	90	20	13	35	10,0	8,0	9,20	0102	○	○	○					
M10x1	1,00	90	20	13	35	10,0	8,0	9,00	0103	●	●	●					
M10x1,25	1,25	100	20	15	39	10,0	8,0	8,80	0104	○	●	●					
										ISO			Vc (m/min)				
										P	5-35	5-35	5-35				
										M	5-15	5-15	5-15				
										K	5-25	5-25	5-25				
										N	10-30	10-30	10-30				
										S	-	-	-				

1

Основная метрическая резьба ISO DIN-13



HSSE

TN2

DIN 374

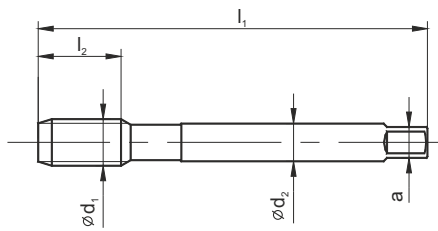

800X

C-TN2

B-TN2

C-R40-TN2



Обрабатываемые материалы

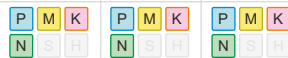

Тип отверстия

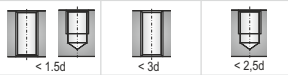

Изготовлен из

HSSE

HSSE

HSSE

Покрытие

TN2

TN2

TN2

Сбег резьбы

C / 2-3P

B / 4-5P

C / 2-3P

MF d ₁	P	l ₁	l ₂	l ₂ R40	l ₃	d ₂	a		Норма	DIN-374			
										Точность	ISO2 (6H)	ISO2 (6H)	ISO2 (6H)
											INDEX	D2-123X01	D2-113X01
M8x1	1,00	90	20	10	-	6,0	4,9	7,00	0083	●	●	●	
M9x1	1,00	90	20	10	-	7,0	5,5	8,00	0093	○	○	○	
M10x0,75	0,75	90	18	10	-	7,0	5,5	9,20	0102	●	●	●	
M10x1	1,00	90	20	10	-	7,0	5,5	9,00	0103	●	●	●	
M10x1,25	1,25	100	20	15	-	7,0	5,5	8,80	0104	●	●	●	
M11x1	1,00	90	20	10	-	8,0	6,2	10,00	0113	○	○	○	
M12x1	1,00	100	20	10	-	9,0	7,0	11,00	0123	●	●	●	
M12x1,25	1,25	100	20	15	-	9,0	7,0	10,80	0124	●	●	●	
M12x1,5	1,50	100	20	15	-	9,0	7,0	10,50	0125	●	●	●	
M14x1	1,00	100	20	10	-	11,0	9,0	13,00	0143	●	●	●	
M14x1,25	1,25	100	20	15	-	11,0	9,0	12,80	0144	●	●	●	
M14x1,5	1,50	100	20	15	-	11,0	9,0	12,50	0145	●	●	●	
M15x1	1,00	100	20	10	-	12,0	9,0	14,00	0153	○	○	○	
M16x1	1,00	100	20	10	-	12,0	9,0	15,00	0163	●	●	●	
M16x1,5	1,50	100	20	15	-	12,0	9,0	14,50	0165	●	●	●	
M18x1	1,00	110	24	13	-	14,0	11,0	17,00	0183	○	○	○	
M18x1,5	1,50	110	24	17	-	14,0	11,0	16,50	0185	●	●	●	
M18x2	2,00	125	27	20	-	14,0	11,0	16,00	0186	●	●	●	
M20x1	1,00	125	24	13	-	16,0	12,0	19,00	0203	○	○	○	
M20x1,5	1,50	125	24	17	-	16,0	12,0	18,50	0205	●	●	●	
M20x2	2,00	140	27	20	-	16,0	12,0	18,00	0206	●	●	●	
M22x1	1,00	125	24	13	-	18,0	14,5	21,00	0223	○	○	○	
M22x1,5	1,50	125	24	17	-	18,0	14,5	20,50	0225	●	●	●	
M22x2	2,00	140	27	20	-	18,0	14,5	20,00	0226	●	●	●	
M24x1	1,00	140	27	13	-	18,0	14,5	23,00	0243	○	○	○	
M24x1,5	1,50	140	27	20	-	18,0	14,5	22,50	0245	●	●	●	
M24x2	2,00	140	27	20	-	18,0	14,5	22,00	0246	●	●	●	
M25x1,5	1,50	140	27	20	-	18,0	14,5	23,50	0253	○	○	○	
M26x1,5	1,50	140	27	20	-	18,0	14,5	24,50	0265	○	○	○	
M27x1,5	1,50	140	27	20	-	20,0	16,0	25,50	0275	●	●	●	
M27x2	2,00	140	27	20	-	20,0	16,0	25,00	0276	●	●	●	
M28x1,5	1,50	140	27	20	-	20,0	16,0	26,50	0285	○	○	○	

● Доступно со склада

○ По запросу

ISO	Vc (m/min)		
P	5-35	5-35	5-35
M	5-15	5-15	5-15
K	5-25	5-25	5-25
N	10-30	10-30	10-30
S	-	-	-

Пример заказа

D2-123X01-0083
800X M8x1-6H DIN-374 C HSSE TN2

Основная метрическая резьба ISO DIN-13										800X					
										C-TN2	B-TN2	C-R40-TN2			
Обрабатываемые материалы															
Тип отверстия															
Изготовлен из										HSSE HSSE HSSE					
Покрытие										TN2 TN2 TN2					
Сбег резьбы										C / 2-3P B / 4-5P C / 2-3P					
MF d ₁	P	l ₁	l ₂	l ₂ R40	l ₃	d ₂	a		Норма Точность INDEX	DIN-374					
										ISO2 (6H)	ISO2 (6H)	ISO2 (6H)			
M28x2	2,0	140	27	20	-	20,0	16,0	26,00	0286	○	○	○			
M30x1,5	1,5	150	27	22	-	22,0	18,0	28,50	0305	●	●	●			
M30x2	2,0	150	27	22	-	22,0	18,0	28,00	0306	●	●	●			
M32x1,5	1,5	150	27	22	-	22,0	18,0	30,50	0325	○	○	○			
M32x2	2,0	150	27	22	-	22,0	18,0	30,00	0326	○	○	○			
M33x1,5	1,5	160	30	22	-	25,0	20,0	31,50	0335	○	○	○			
M33x2	2,0	160	30	24	-	25,0	20,0	31,00	0336	○	○	○			
M34x1,5	1,5	170	30	22	-	28,0	22,0	32,50	0345	○	○	○			
M35x1,5	1,5	170	30	22	-	28,0	22,0	33,50	0355	○	○	○			
M36x1,5	1,5	170	30	22	-	28,0	22,0	34,50	0365	○	○	○			
M36x2	2,0	170	30	24	-	28,0	22,0	34,00	0366	○	○	○			
M36x3	3,0	200	50	30	-	28,0	22,0	33,00	0367	○	○	○			
M38x1,5	1,5	170	30	24	-	28,0	22,0	36,50	0385	○	○	○			
M39x1,5	1,5	170	30	25	-	32,0	24,0	37,50	0395	○	○	○			
M39x2	2,0	170	30	25	-	32,0	24,0	37,00	0396	○	○	○			
M39x3	3,0	200	50	30	-	32,0	24,0	36,00	0397	○	○	○			
M40x1,5	1,5	170	30	25	-	32,0	24,0	38,50	0405	○	○	○			
M40x2	2,0	170	30	25	-	32,0	24,0	38,00	0406	○	○	○			
M42x1,5	1,5	170	30	25	-	32,0	24,0	40,50	0425	○	○	○			
M42x2	2,0	170	30	25	-	32,0	24,0	40,00	0426	○	○	○			
M42x3	3,0	200	50	30	-	32,0	24,0	39,00	0427	○	○	○			
M45x1,5	1,5	180	30	27	-	36,0	29,0	43,50	0455	○	○	○			
M45x2	2,0	180	30	27	-	36,0	29,0	43,00	0456	○	○	○			
M45x3	3,0	200	50	30	-	36,0	29,0	42,00	0457	○	○	○			
M48x1,5	1,5	190	30	27	-	36,0	29,0	46,50	0485	○	○	○			
M48x2	2,0	190	30	27	-	36,0	29,0	46,00	0486	○	○	○			
M48x3	3,0	225	50	33	-	36,0	29,0	45,00	0487	○	○	○			
M50x1,5	1,5	190	30	27	-	36,0	29,0	48,50	0505	○	○	○			
M50x2	2,0	190	30	33	-	36,0	29,0	48,00	0506	○	○	○			
M52x1,5	1,5	190	32	27	-	40,0	32,0	50,50	0525	○	○	○			
M52x2	2,0	190	32	33	-	40,0	32,0	50,00	0526	○	○	○			
M52x3	3,0	225	50	33	-	40,0	32,0	49,00	0527	○	○	○			

- Доступно со склада
- По запросу

ISO	V _c (m/min)					
P	5-35	5-35	5-35			
M	5-15	5-15	5-15			
K	5-25	5-25	5-25			
N	10-30	10-30	10-30			
S	-	-	-			

Пример заказа

 D2-123X01-0305
 800X M30x1,5-6H DIN-374 C HSSE TN2

1

Основная метрическая резьба ISO DIN-13										800						
										C	B	C-R40				
Обрабатываемые материалы																
Тип отверстия																
Изготовлен из										HSSE	HSSE	HSSE				
Покрытие																
Сбег резьбы										C / 2-3P	B / 4-5P	C / 2-3P				
MF d ₁	P	l ₁	l ₂	l ₂ R40	l ₃	d ₂	a		Норма	DIN-371						
									Точность	ISO2 (6H)	ISO2 (6H)	ISO2 (6H)				
									INDEX	C2-121101	C2-111101	C2-511101				
M3x0,35	0,35	56	10	5	18	3,5	2,7	2,65	0031	●	●	●				
M3,5x0,35	0,35	56	10	5	20	4,0	3,0	3,15	0036	●	●	●				
M4x0,5	0,50	63	12	7	21	4,5	3,4	3,50	0041	●	●	●				
M5x0,5	0,50	70	14	8	25	6,0	4,9	4,50	0051	●	●	●				
M6x0,75	0,75	80	14	10	30	6,0	4,9	5,20	0062	●	●	●				
M8x0,75	0,75	80	18	10	30	8,0	6,2	7,20	0082	●	●	●				
M8x1	1,00	90	20	13	35	8,0	6,2	7,00	0083	●	●	●				
M10x0,75	0,75	90	20	13	35	10,0	8,0	9,20	0102	●	●	●				
M10x1	1,00	90	20	13	35	10,0	8,0	9,00	0103	●	●	●				
M10x1,25	1,25	100	20	15	39	10,0	8,0	8,80	0104	●	●	●				
										ISO			Vc (m/min)			
										P	5-20	5-20	5-20			
										M	-	-	-			
										K	5-15	5-15	5-15			
										N	5-25	5-25	5-25			
										S	-	-	-			

Основная метрическая резьба ISO DIN-13										800							
Обрабатываемые материалы																	
Тип отверстия																	
Изготовлен из										HSSE	HSSE	HSSE					
Покрытие																	
Сбег резьбы										C / 2-3P	B / 4-5P	C / 2-3P					
MF d ₁	P	l ₁	l ₂	l ₂ R40 R45	l ₃	d ₂	a		Норма Точность INDEX	DIN-374							
										ISO2 (6H)	ISO2 (6H)	ISO2 (6H)					
										D2-121101	D2-111101	D2-511101					
M8x1	1,00	90	20	10	-	6,0	4,9	7,00	0083	●	●	●					
M9x1	1,00	90	20	10	-	7,0	5,5	8,00	0093	○	○	○					
M10x0,75	0,75	90	18	10	-	7,0	5,5	9,20	0102	●	●	●					
M10x1	1,00	90	20	10	-	7,0	5,5	9,00	0103	●	●	●					
M10x1,25	1,25	100	20	15	-	7,0	5,5	8,80	0104	●	●	●					
M11x1	1,00	90	20	10	-	8,0	6,2	10,00	0113	○	○	○					
M12x1	1,00	100	20	10	-	9,0	7,0	11,00	0123	●	●	●					
M12x1,25	1,25	100	20	15	-	9,0	7,0	10,80	0124	●	●	●					
M12x1,5	1,50	100	20	15	-	9,0	7,0	10,50	0125	●	●	●					
M14x1	1,00	100	20	10	-	11,0	9,0	13,00	0143	●	●	●					
M14x1,25	1,25	100	20	15	-	11,0	9,0	12,80	0144	●	●	●					
M14x1,5	1,50	100	20	15	-	11,0	9,0	12,50	0145	●	●	●					
M15x1	1,00	100	20	10	-	12,0	9,0	14,00	0153	○	○	○					
M16x1	1,00	100	20	10	-	12,0	9,0	15,00	0163	●	●	●					
M16x1,5	1,50	100	20	15	-	12,0	9,0	14,50	0165	●	●	●					
M18x1	1,00	110	24	13	-	14,0	11,0	17,00	0183	○	○	○					
M18x1,5	1,50	110	24	17	-	14,0	11,0	16,50	0185	●	●	●					
M18x2	2,00	125	27	20	-	14,0	11,0	16,00	0186	●	●	●					
M20x1	1,00	125	24	13	-	16,0	12,0	19,00	0203	○	○	○					
M20x1,5	1,50	125	24	17	-	16,0	12,0	18,50	0205	●	●	●					
M20x2	2,00	140	27	20	-	16,0	12,0	18,00	0206	●	●	●					
M22x1	1,00	125	24	13	-	18,0	14,5	21,00	0223	○	○	○					
M22x1,5	1,50	125	24	17	-	18,0	14,5	20,50	0225	●	●	●					
M22x2	2,00	140	27	20	-	18,0	14,5	20,00	0226	●	●	●					
M24x1	1,00	140	27	13	-	18,0	14,5	23,00	0243	○	○	○					
M24x1,5	1,50	140	27	20	-	18,0	14,5	22,50	0245	●	●	●					
M24x2	2,00	140	27	20	-	18,0	14,5	22,00	0246	●	●	●					
M25x1,5	1,50	140	27	20	-	18,0	14,5	23,50	0253	○	○	○					
M26x1,5	1,50	140	27	20	-	18,0	14,5	24,50	0265	○	○	○					
M27x1,5	1,50	140	27	20	-	20,0	16,0	25,50	0275	●	●	●					
M27x2	2,00	140	27	20	-	20,0	16,0	25,00	0276	●	●	●					
M28x1,5	1,50	140	27	20	-	20,0	16,0	26,50	0285	○	○	○					

- Доступно со склада
- По запросу

Пример заказа
D2-121101-0083
800 M8x1-6H DIN-374 C HSSE

ISO	Vc (m/min)						
P	5-20	5-20	5-20				
M	-	-	-				
K	5-15	5-15	5-15				
N	5-25	5-25	5-25				
S	-	-	-				

1

Основная метрическая резьба ISO DIN-13

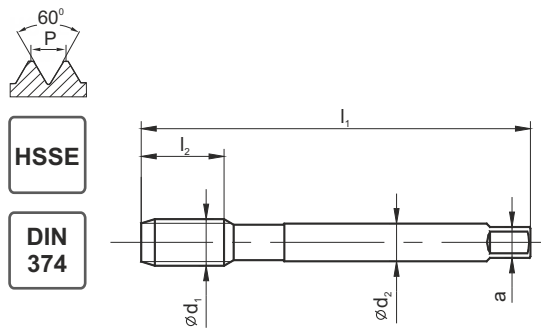

HSSE

DIN
374

800

C

B

C-R40



Обрабатываемые материалы



Тип отверстия

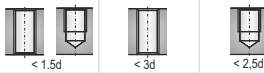

Изготовлен из

HSSE

HSSE

HSSE

Покрытие

Сбег резьбы

C / 2-3P

B / 4-5P

C / 2-3P

MF d ₁	P	l ₁	l ₂	l ₂ R40	l ₃	d ₂	a		Норма	DIN-374			
										Точность			
										ISO2 (6H)	ISO2 (6H)	ISO2 (6H)	
										INDEX	D2-121101	D2-111101	D2-511101
M28x2	2,0	140	27	20	-	20,0	16,0	26,00	0286	○	○	○	
M30x1,5	1,5	150	27	22	-	22,0	18,0	28,50	0305	●	●	●	
M30x2	2,0	150	27	22	-	22,0	18,0	28,00	0306	●	●	●	
M32x1,5	1,5	150	27	22	-	22,0	18,0	30,50	0325	○	○	○	
M32x2	2,0	150	27	22	-	22,0	18,0	30,00	0326	○	○	○	
M33x1,5	1,5	160	30	22	-	25,0	20,0	31,50	0335	●	●	●	
M33x2	2,0	160	30	24	-	25,0	20,0	31,00	0336	●	●	●	
M34x1,5	1,5	170	30	22	-	28,0	22,0	32,50	0345	○	○	○	
M35x1,5	1,5	170	30	22	-	28,0	22,0	33,50	0355	○	○	○	
M36x1,5	1,5	170	30	22	-	28,0	22,0	34,50	0365	●	●	●	
M36x2	2,0	170	30	24	-	28,0	22,0	34,00	0366	●	●	●	
M36x3	3,0	200	50	30	-	28,0	22,0	33,00	0367	○	○	○	
M38x1,5	1,5	170	30	24	-	28,0	22,0	36,50	0385	○	○	○	
M39x1,5	1,5	170	30	25	-	32,0	24,0	37,50	0395	○	○	○	
M39x2	2,0	170	30	25	-	32,0	24,0	37,00	0396	○	○	○	
M39x3	3,0	200	50	30	-	32,0	24,0	36,00	0397	○	○	○	
M40x1,5	1,5	170	30	25	-	32,0	24,0	38,50	0405	○	○	○	
M40x2	2,0	170	30	25	-	32,0	24,0	38,00	0406	○	○	○	
M42x1,5	1,5	170	30	25	-	32,0	24,0	40,50	0425	○	○	○	
M42x2	2,0	170	30	25	-	32,0	24,0	40,00	0426	○	○	○	
M42x3	3,0	200	50	30	-	32,0	24,0	39,00	0427	○	○	○	
M45x1,5	1,5	180	30	27	-	36,0	29,0	43,50	0455	○	○	○	
M45x2	2,0	180	30	27	-	36,0	29,0	43,00	0456	○	○	○	
M45x3	3,0	200	50	30	-	36,0	29,0	42,00	0457	○	○	○	
M48x1,5	1,5	190	30	27	-	36,0	29,0	46,50	0485	○	○	○	
M48x2	2,0	190	30	27	-	36,0	29,0	46,00	0486	○	○	○	
M48x3	3,0	225	50	33	-	36,0	29,0	45,00	0487	○	○	○	
M50x1,5	1,5	190	30	27	-	36,0	29,0	48,50	0505	○	○	○	
M50x2	2,0	190	30	33	-	36,0	29,0	48,00	0506	○	○	○	
M52x1,5	1,5	190	32	27	-	40,0	32,0	50,50	0525	○	○	○	
M52x2	2,0	190	32	33	-	40,0	32,0	50,00	0526	○	○	○	
M52x3	3,0	225	50	33	-	40,0	32,0	49,00	0527	○	○	○	

● Доступно со склада

○ По запросу

ISO	Vc (m/min)		
P	5-20	5-20	5-20
M	-	-	-
K	5-15	5-15	5-15
N	5-25	5-25	5-25
S	-	-	-

Основная метрическая резьба ISO DIN-13										<i>FAN-1200</i>		<i>1400</i>							
										B-TC	C-R40-TC	C-TC	B-TC	C-R15-TC					
Обрабатываемые материалы										P M K N S H		P M K N S H		P M K N S H		P M K N S H		P M K N S H	
Тип отверстия																			
Изготовлен из										HSSE-PM		HSSE-PM		HSSE-PM		HSSE-PM		HSSE-PM	
Покрытие										TC		TC		TC		TC		TC	
Сбег резьбы										B / 4-5P		C / 2-3P		C / 2-3P		B / 4-5P		C / 2-3P	
MF d ₁	P	l ₁	l ₂	l ₂ R40	l ₃	d ₂	a		Норма	DIN-371									
										Точность	ISO2 (6H)	ISO2 (6H)	6HX	6HX	6HX				
									INDEX	C4-115001	C4-565001	C4-125901	C4-115901	C4-505901					
M4x0,5	0,50	63	12	7	21	4,5	3,4	3,50	0041	○	○	○	○	○					
M5x0,5	0,50	70	14	8	25	6,0	4,9	4,50	0051	○	○	○	○	○					
M6x0,75	0,75	80	14	10	30	6,0	4,9	5,20	0062	○	○	○	○	○					
M8x0,75	0,75	80	18	10	30	8,0	6,2	7,20	0082	○	○	○	○	○					
M8x1	1,00	90	20	13	35	8,0	6,2	7,00	0083	●	●	●	●	●					
M10x0,75	0,75	90	20	13	35	10,0	8,0	9,20	0102	○	○	○	○	○					
M10x1	1,00	90	20	13	35	10,0	8,0	9,00	0103	●	●	●	●	●					
M10x1,25	1,25	100	20	15	39	10,0	8,0	8,80	0104	○	○	○	○	○					

ISO	Vc (m/min)				
P	5-35	5-35	1-20	1-20	1-20
M	5-15	5-15	1-10	1-10	1-10
K	5-25	5-25	1-20	1-20	1-20
N	10-30	10-30	10-20	10-20	10-20
S	-	-	-	-	-

1

Основная метрическая резьба ISO DIN-13										<i>FAN-1200</i>		<i>1400</i>									
										B-TC	C-R40-TC	C-TC	B-TC	C-R15-TC							
 <div style="display: flex; flex-direction: column; gap: 5px;"> <div style="border: 1px solid black; padding: 2px; width: fit-content;">HSSE PM</div> <div style="border: 1px solid black; padding: 2px; width: fit-content;">TC</div> <div style="border: 1px solid black; padding: 2px; width: fit-content;">DIN 374</div> </div>																					
Обрабатываемые материалы										P M K	P M K	P M K	P M K	P M K							
Тип отверстия																					
Изготовлен из										PM/HSSE	PM/HSSE	PM/HSSE	PM/HSSE	PM/HSSE							
Покрытие										TC	TC	TC	TC	TC							
Сбег резьбы										B / 4-5P	C / 2-3P	C / 2-3P	B / 4-5P	C / 2-3P							
MF d ₁	P	l ₁	l ₂	l ₂ R40	l ₃	d ₂	a		Норма	DIN-374											
										Точность	ISO2 (6H)	ISO2 (6H)	6HX	6HX			6HX				
										INDEX	D4-115001	D4-565001	D4-125901	D4-115901	D4-505901						
M8x1	1,00	90	20	10	-	6,0	4,9	7,00	0083	●	●	●	●	●							
M10x0,75	0,75	90	18	10	-	7,0	5,5	9,20	0102	○	○	○	○	○							
M10x1	1,00	90	20	10	-	7,0	5,5	9,00	0103	●	●	●	●	●							
M10x1,25	1,25	100	20	15	-	7,0	5,5	8,80	0104	○	○	○	○	○							
M12x1	1,00	100	20	10	-	9,0	7,0	11,00	0123	●	●	●	●	●							
M12x1,25	1,25	100	20	15	-	9,0	7,0	10,80	0124	●	●	●	●	●							
M12x1,5	1,50	100	20	15	-	9,0	7,0	10,50	0125	●	●	●	●	●							
M14x1	1,00	100	20	10	-	11,0	9,0	13,00	0143	○	○	○	○	●							
M14x1,25	1,25	100	20	15	-	11,0	9,0	12,80	0144	○	○	○	○	○							
M14x1,5	1,50	100	20	15	-	11,0	9,0	12,50	0145	●	●	●	●	●							
M16x1	1,00	100	20	10	-	12,0	9,0	15,00	0163	●	●	●	●	●							
M16x1,5	1,50	100	20	15	-	12,0	9,0	14,50	0165	●	●	●	●	●							
M18x1	1,00	110	24	13	-	14,0	11,0	17,00	0183	○	○	○	○	○							
M18x1,5	1,50	110	24	17	-	14,0	11,0	16,50	0185	●	●	●	●	●							
M18x2	2,00	125	32	27	-	14,0	11,0	16,00	0186	●	○	○	○	○							
M20x1	1,00	125	24	13	-	16,0	12,0	19,00	0203	○	○	○	○	○							
M20x1,5	1,50	125	24	17	-	16,0	12,0	18,50	0205	●	●	●	●	●							
M20x2	2,00	140	32	27	-	16,0	12,0	18,00	0206	○	○	○	○	○							
M22x1	1,00	125	24	13	-	18,0	14,5	21,00	0223	○	○	○	○	○							
M22x1,5	1,50	125	24	17	-	18,0	14,5	20,50	0225	○	○	○	○	○							
M22x2	2,00	140	32	27	-	18,0	14,5	20,00	0226	○	○	○	○	○							
M24x1	1,00	140	27	13	-	18,0	14,5	23,00	0243	○	○	○	○	○							
M24x1,5	1,50	140	27	20	-	18,0	14,5	22,50	0245	○	○	○	○	○							
M24x2	2,00	140	27	20	-	18,0	14,5	22,00	0246	○	○	○	○	○							
										Vc (m/min)											
										P	5-35	5-35	1-20	1-20	1-20						
										M	5-15	5-15	1-10	1-10	1-10						
										K	5-25	5-25	1-20	1-20	1-20						
										N	10-30	10-30	10-20	10-20	10-20						
										S	-	-	-	-	-						

Основная метрическая резьба ISO DIN-13										INOX																																						
										B	B-HL	C-R40	C-R40-HL																																			
Обрабатываемые материалы										<table border="1"> <tr> <td>P</td><td>M</td><td>K</td><td></td> <td>P</td><td>M</td><td>K</td><td></td> <td>P</td><td>M</td><td>K</td><td></td> <td>P</td><td>M</td><td>K</td><td></td> </tr> <tr> <td>N</td><td>S</td><td>H</td><td></td> <td>N</td><td>S</td><td>H</td><td></td> <td>N</td><td>S</td><td>H</td><td></td> <td>N</td><td>S</td><td>H</td><td></td> </tr> </table>				P	M	K		P	M	K		P	M	K		P	M	K		N	S	H		N	S	H		N	S	H		N	S	H				
P	M	K		P	M	K		P	M	K		P	M	K																																		
N	S	H		N	S	H		N	S	H		N	S	H																																		
Тип отверстия																																																
Изготовлен из										HSSE																																						
Покрытие														HL																																		
Сбег резьбы										B / 4-5P				B / 4-5P																																		
										DIN-371																																						
MF d_1	P	l_1	l_2	l_2 R40	l_3	d_2	a		Норма																																							
									Точность	ISO2 (6H)	ISO2 (6H)	ISO2 (6H)	ISO2 (6H)																																			
									INDEX	C2-111801	C2-118801	C2-511801	C2-518801																																			
M4x0,5	0,50	63	12	7	21	4,5	3,4	3,50	0041	●	●	●	●																																			
M5x0,5	0,50	70	14	8	25	6,0	4,9	4,50	0051	●	●	●	●																																			
M6x0,75	0,75	80	14	10	30	6,0	4,9	5,20	0062	●	●	●	●																																			
M8x0,75	0,75	80	18	10	30	8,0	6,2	7,20	0082	●	●	●	●																																			
M8x1	1,00	90	20	13	35	8,0	6,2	7,00	0083	●	●	●	●																																			
M10x0,75	0,75	90	20	13	35	10,0	8,0	9,20	0102	●	●	●	●																																			
M10x1	1,00	90	20	13	35	10,0	8,0	9,00	0103	●	●	●	●																																			
M10x1,25	1,25	100	20	15	39	10,0	8,0	8,80	0104	●	●	●	●																																			
										Vc (m/min)																																						
										P	-	-	-	-																																		
										M	5-15	5-15	5-15	5-15																																		
										K	-	-	-	-																																		
										N	-	-	-	-																																		
										S	-	-	-	-																																		

1

Основная метрическая резьба ISO DIN-13

INOX



HSSE

HL

DIN 374

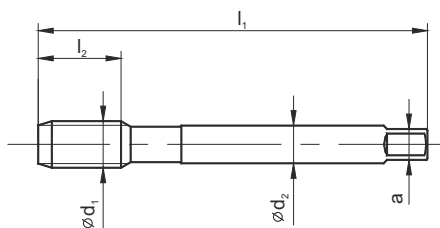

B B-HL C-R40 C-R40-HL



Обрабатываемые материалы

P	M	K	P	M	K	P	M	K	P	M	K
N	S	H	N	S	H	N	S	H	N	S	H

Тип отверстия

< 3d	< 3d	< 2.5d	< 2.5d
------	------	--------	--------

Изготовлен из

HSSE	HSSE	HSSE	HSSE
------	------	------	------

Покрытие

	HL		HL
--	----	--	----

Сбег резьбы

B / 4-5P	B / 4-5P	C / 2-3P	C / 2-3P
----------	----------	----------	----------

MF d ₁	P	l ₁	l ₂	l ₂ R40	l ₃	d ₂	a		Норма	DIN-374			
										Точность			
										ISO2 (6H)	ISO2 (6H)	ISO2 (6H)	ISO2 (6H)
INDEX	D2-111801	D2-118801	D2-511801	D2-518801									
M8x1	1,00	90	20	10	-	6,0	4,9	7,00	0083	●	○	●	○
M10x0,75	0,75	90	18	10	-	7,0	5,5	9,20	0102	●	○	●	○
M10x1	1,00	90	20	10	-	7,0	5,5	9,00	0103	●	●	●	●
M10x1,25	1,25	100	20	15	-	7,0	5,5	8,80	0104	●	○	●	○
M12x1	1,00	100	20	10	-	9,0	7,0	11,00	0123	●	○	●	○
M12x1,25	1,25	100	20	15	-	9,0	7,0	10,80	0124	●	○	●	○
M12x1,5	1,50	100	20	15	-	9,0	7,0	10,50	0125	●	●	●	●
M14x1	1,00	100	20	10	-	11,0	9,0	13,00	0143	○	○	○	○
M14x1,25	1,25	100	20	15	-	11,0	9,0	12,80	0144	○	○	○	○
M14x1,5	1,50	100	20	15	-	11,0	9,0	12,50	0145	●	○	●	○
M15x1	1,00	100	20	10	-	12,0	9,0	14,00	0153	○	○	○	○
M16x1	1,00	100	20	10	-	12,0	9,0	15,00	0163	●	○	●	○
M16x1,5	1,50	100	20	15	-	12,0	9,0	14,50	0165	●	●	●	●
M18x1	1,00	110	24	13	-	14,0	11,0	17,00	0183	○	○	○	○
M18x1,5	1,50	110	24	17	-	14,0	11,0	16,50	0185	●	○	●	○
M18x2	2,00	125	27	20	-	14,0	11,0	16,00	0186	○	○	○	○
M20x1	1,00	125	24	13	-	16,0	12,0	19,00	0203	○	○	○	○
M20x1,5	1,50	125	24	17	-	16,0	12,0	18,50	0205	●	●	●	●
M20x2	2,00	140	27	20	-	16,0	12,0	18,00	0206	○	○	○	○
M22x1	1,00	125	24	13	-	18,0	14,5	21,00	0223	○	○	○	○
M22x1,5	1,50	125	24	17	-	18,0	14,5	20,50	0225	●	○	●	○
M22x2	2,00	140	27	20	-	18,0	14,5	20,00	0226	○	○	○	○
M24x1	1,00	140	27	13	-	18,0	14,5	23,00	0243	○	○	○	○
M24x1,5	1,50	140	27	20	-	18,0	14,5	22,50	0245	○	○	○	○
M24x2	2,00	140	27	20	-	18,0	14,5	22,00	0246	○	○	○	○
M26x1,5	1,50	140	27	20	-	18,0	14,5	24,50	0265	○	○	○	○
M27x1,5	1,50	140	27	20	-	20,0	16,0	25,50	0275	○	○	○	○
M27x2	2,00	140	27	20	-	20,0	16,0	25,00	0276	○	○	○	○
M28x1,5	1,50	140	27	20	-	20,0	16,0	26,50	0285	○	○	○	○

- Доступно со склада
- По запросу

ISO	Vc (m/min)			
P	-	-	-	-
M	5-15	5-15	5-15	5-15
K	-	-	-	-
N	-	-	-	-
S	-	-	-	-

Основная метрическая резьба ISO DIN-13										INOX							
										B	B-HL	C-R40	C-R40-HL				
Обрабатываемые материалы																	
Тип отверстия																	
Изготовлен из										HSSE HSSE HSSE HSSE							
Покрытие										HL HL							
Сбег резьбы										B / 4-5P B / 4-5P C / 2-3P C / 2-3P							
MF d ₁	P	l ₁	l ₂	l ₂ R40	l ₃	d ₂	a		Норма Точность INDEX	DIN-374							
										ISO2 (6H)	ISO2 (6H)	ISO2 (6H)	ISO2 (6H)				
M28x2	2,0	140	27	20	-	20,0	16,0	26,00	0286	o	o	o	o				
M30x1,5	1,5	150	27	22	-	22,0	18,0	28,50	0305	o	o	o	o				
M30x2	2,0	150	27	22	-	22,0	18,0	28,00	0306	o	o	o	o				
M32x1,5	1,5	150	27	22	-	22,0	18,0	30,50	0325	o	o	o	o				
M32x2	2,0	150	27	22	-	22,0	18,0	30,00	0326	o	o	o	o				
M33x1,5	1,5	160	30	22	-	25,0	20,0	31,50	0335	o	o	o	o				
M33x2	2,0	160	30	24	-	25,0	20,0	31,00	0336	o	o	o	o				
M34x1,5	1,5	170	30	22	-	28,0	22,0	32,50	0345	o	o	o	o				
M35x1,5	1,5	170	30	22	-	28,0	22,0	33,50	0355	o	o	o	o				
M36x1,5	1,5	170	30	22	-	28,0	22,0	34,50	0365	o	o	o	o				
M36x2	2,0	170	30	24	-	28,0	22,0	34,00	0366	o	o	o	o				
M36x3	3,0	200	50	30	-	28,0	22,0	33,00	0367	o	o	o	o				
ISO										Vc (m/min)							
P										-							
M										5-15							
K										-							
N										-							
S										-							

1

Основная метрическая резьба ISO DIN-13										GG					GAL																																																																																																																				
										C-TC	C-IK-TC	E-TC	E-IK-TC	E-IKR-TC	C-R15-TC	E-R15-IK-TC																																																																																																																			
Обрабатываемые материалы																				P M K	P M K	P M K	P M K	P M K	P M K	P M K																																																																																																									
Тип отверстия										N S H	N S H	N S H	N S H	N S H	N S H	N S H	N S H																																																																																																																		
Изготовлен из										HSSE-PM	HSSE-PM	HSSE-PM	HSSE-PM	HSSE-PM	HSSE-PM	HSSE-PM																																																																																																																			
Покрытие										TC	TC	TC	TC	TC	TC	TC																																																																																																																			
Сбег резьбы										C / 2-3P	C / 2-3P	E / 1,5-2P	E / 1,5-2P	E / 1,5-2P	C / 2-3P	E / 1,5-2P																																																																																																																			
<table border="1"> <thead> <tr> <th rowspan="2">MF</th> <th rowspan="2">d₁</th> <th rowspan="2">P</th> <th rowspan="2">l₁</th> <th rowspan="2">l₂</th> <th rowspan="2">l₃</th> <th rowspan="2">d₂</th> <th rowspan="2">a</th> <th rowspan="2"> </th> <th colspan="7">Норма</th> </tr> <tr> <th colspan="7">DIN-371</th> <th>Точность</th> <th>6HX</th> <th>6HX</th> <th>6HX</th> <th>6HX</th> <th>6HX</th> <th>6HX</th> </tr> <tr> <th colspan="10"></th> <th>INDEX</th> <th>C2-125501</th> <th>C4-125551</th> <th>C2-145501</th> <th>C4-145551</th> <th>C4-145561</th> <th>C2-505601</th> <th>C4-655601</th> </tr> </thead> <tbody> <tr> <td>M8x1</td> <td>1,00</td> <td>90</td> <td>20</td> <td>35</td> <td>8,0</td> <td>6,2</td> <td>7,00</td> <td> </td> <td>0083</td> <td>●</td> <td>○</td> <td>●</td> <td>○</td> <td>○</td> <td>●</td> <td>○</td> </tr> <tr> <td>M10x0,75</td> <td>0,75</td> <td>90</td> <td>20</td> <td>35</td> <td>10,0</td> <td>8,0</td> <td>9,20</td> <td> </td> <td>0102</td> <td>○</td> <td>○</td> <td>○</td> <td>○</td> <td>○</td> <td>○</td> <td>○</td> </tr> <tr> <td>M10x1</td> <td>1,00</td> <td>90</td> <td>20</td> <td>35</td> <td>10,0</td> <td>8,0</td> <td>9,00</td> <td> </td> <td>0103</td> <td>●</td> <td>○</td> <td>●</td> <td>○</td> <td>○</td> <td>●</td> <td>○</td> </tr> <tr> <td>M10x1,25</td> <td>1,25</td> <td>100</td> <td>20</td> <td>39</td> <td>10,0</td> <td>8,0</td> <td>8,80</td> <td> </td> <td>0104</td> <td>○</td> <td>○</td> <td>●</td> <td>○</td> <td>○</td> <td>●</td> <td>○</td> </tr> </tbody> </table>										MF	d ₁	P	l ₁	l ₂	l ₃	d ₂	a		Норма							DIN-371							Точность	6HX	6HX	6HX	6HX	6HX	6HX											INDEX	C2-125501	C4-125551	C2-145501	C4-145551	C4-145561	C2-505601	C4-655601	M8x1	1,00	90	20	35	8,0	6,2	7,00		0083	●	○	●	○	○	●	○	M10x0,75	0,75	90	20	35	10,0	8,0	9,20		0102	○	○	○	○	○	○	○	M10x1	1,00	90	20	35	10,0	8,0	9,00		0103	●	○	●	○	○	●	○	M10x1,25	1,25	100	20	39	10,0	8,0	8,80		0104	○	○	●	○	○	●	○	Vc (m/min)	P	M	K	N	S
MF	d ₁	P	l ₁	l ₂	l ₃	d ₂	a		Норма																																																																																																																										
									DIN-371							Точность	6HX	6HX	6HX	6HX	6HX	6HX																																																																																																													
										INDEX	C2-125501	C4-125551	C2-145501	C4-145551	C4-145561	C2-505601	C4-655601																																																																																																																		
M8x1	1,00	90	20	35	8,0	6,2	7,00		0083	●	○	●	○	○	●	○																																																																																																																			
M10x0,75	0,75	90	20	35	10,0	8,0	9,20		0102	○	○	○	○	○	○	○																																																																																																																			
M10x1	1,00	90	20	35	10,0	8,0	9,00		0103	●	○	●	○	○	●	○																																																																																																																			
M10x1,25	1,25	100	20	39	10,0	8,0	8,80		0104	○	○	●	○	○	●	○																																																																																																																			
										P	-	-	-	-	-	-	-																																																																																																																		
										M	-	-	-	-	-	-	-																																																																																																																		
										K	1-60	1-60	1-60	1-60	1-60	-	-																																																																																																																		
										N	-	-	-	-	-	10-30	10-30																																																																																																																		
										S	-	-	-	-	-	-	-																																																																																																																		



Основная метрическая резьба ISO DIN-13								GG					GAL						
								C-TC	C-IK-TC	E-TC	E-IK-TC	E-IKR-TC	C-R15-TC	E-R15-IK-TC					
Обрабатываемые материалы								P M K		P M K		P M K		P M K		P M K		P M K	
Тип отверстия								N S H		N S H		N S H		N S H		N S H		N S H	
Изготовлен из								HSSE-PM		HSSE-PM		HSSE-PM		HSSE-PM		HSSE-PM		HSSE-PM	
Покрытие								TC		TC		TC		TC		TC		TC	
Сбег резьбы								C / 2-3P		C / 2-3P		E / 1,5-2P		E / 1,5-2P		C / 2-3P		E / 1,5-2P	
MF d ₁	P	l ₁	l ₂	d ₂	a		Норма	DIN-374											
								Точность	6HX	6HX	6HX	6HX	6HX	6HX	6HX				
							INDEX	D2-125501	D4-125551	D2-145501	D4-145551	D4-145561	D2-505601	D4-655601					
M8x1	1,00	90	20	6,0	4,9	7,00	0083	●	○	●	○	○	●	○					
M10x0,75	0,75	90	18	7,0	5,5	9,2	0102	○	○	○	○	○	○	○					
M10x1	1,00	90	20	7,0	5,5	9,00	0103	●	●	●	○	○	●	●					
M10x1,25	1,25	100	20	7,0	5,5	8,80	0104	○	○	○	○	○	○	○					
M12x1	1,00	100	20	9,0	7,0	11,00	0123	○	○	○	○	○	○	○					
M12x1,25	1,25	100	20	9,0	7,0	10,80	0124	○	○	○	○	○	○	○					
M12x1,5	1,50	100	20	9,0	7,0	10,50	0125	●	●	●	○	○	●	●					
M14x1	1,00	100	20	11,0	9,0	13,00	0143	○	○	○	○	○	○	○					
M14x1,25	1,25	100	20	11,0	9,0	12,80	0144	○	○	○	○	○	○	○					
M14x1,5	1,50	100	20	11,0	9,0	12,50	0145	●	●	●	○	○	●	●					
M16x1	1,00	100	20	12,0	9,0	15,00	0163	○	○	○	○	○	○	○					
M16x1,5	1,50	100	20	12,0	9,0	14,50	0165	●	●	●	○	○	●	●					
M18x1	1,00	110	24	14,0	11,0	17,00	0183	○	○	○	○	○	○	○					
M18x1,5	1,50	110	24	14,0	11,0	16,50	0185	●	○	●	○	○	○	○					
M18x2	2,00	125	27	14,0	11,0	16,00	0186	○	○	○	○	○	○	○					
M20x1	1,00	125	24	16,0	12,0	19,00	0203	○	○	○	○	○	○	○					
M20x1,5	1,50	125	24	16,0	12,0	18,50	0205	●	○	○	○	○	○	○					
M20x2	2,00	140	27	16,0	12,0	18,00	0206	○	○	○	○	○	○	○					
								Vc (m/min)											
ISO																			
P								-											
M								-											
K								1-60											
N								-											
S								-											

1

Основная метрическая резьба ISO DIN-13										S-NC							
										B-TC	C-R45-TC	C-R45-IK-TC					
Обрабатываемые материалы																	
Тип отверстия																	
Изготовлен из										HSSE-PM							
Покрытие										TC							
Сбег резьбы										B / 4-5P							
MF d ₁	P	l ₁	l ₂	l ₂ R45	l ₃	d ₂	a		Норма	DIN-371							
									Точность	6HX	6HX	6HX					
									INDEX	C4-115301	C4-525301	C4-525351					
M4x0,5	0,50	63	12	7	21	4,5	3,4	3,50	0041	○	○	○					
M5x0,5	0,50	70	14	8	25	6,0	4,9	4,50	0051	○	○	○					
M6x0,75	0,75	80	14	10	30	6,0	4,9	5,20	0062	○	○	○					
M8x0,75	0,75	80	18	10	30	8,0	6,2	7,20	0082	●	●	○					
M8x1	1,00	90	20	13	35	8,0	6,2	7,00	0083	○	○	○					
M10x0,75	0,75	90	20	13	35	10,0	8,0	9,20	0102	○	○	○					
M10x1	1,00	90	20	13	35	10,0	8,0	9,00	0103	●	●	○					
M10x1,25	1,25	100	20	15	39	10,0	8,0	8,80	0104	○	○	○					
										ISO			V _c (m/min)				
										P	5-50	5-50	5-60				
										M	5-20	5-20	5-30				
										K	5-40	5-40	5-60				
										N	5-40	5-40	5-60				
										S	1-8	1-8	1-8				

Основная метрическая резьба ISO DIN-13										S-NC							
										B-TC	C-R45-TC	C-R45-IK-TC					
Обрабатываемые материалы																	
Тип отверстия																	
Изготовлен из										PM/HSSE							
Покрытие										TC							
Сбег резьбы										B / 4-5P C / 2-3P C / 2-3P							
MF d ₁	P	l ₁	l ₂	l ₂ R45	l ₃	d ₂	a		Норма								
									DIN-374								
									Точность	6HX	6HX	6HX					
										INDEX	D4-115301	D4-525301	D4-525351				
M8x1	1,00	90	20	10	-	6,0	4,9	7,00	0083	○	○	○					
M10x1	1,00	90	20	10	-	7,0	5,5	9,00	0103	○	○	○					
M10x1,25	1,25	100	20	15	-	7,0	5,5	8,80	0104	○	○	○					
M11x1	1,00	90	20	10	-	8,0	6,2	10,00	0113	○	○	○					
M12x1	1,00	100	20	10	-	9,0	7,0	11,00	0123	○	○	○					
M12x1,25	1,25	100	20	15	-	9,0	7,0	10,80	0124	○	○	○					
M12x1,5	1,50	100	20	15	-	9,0	7,0	10,50	0125	●	●	○					
M14x1	1,00	100	20	10	-	11,0	9,0	13,00	0143	○	○	○					
M14x1,25	1,25	100	20	15	-	11,0	9,0	12,80	0144	○	○	○					
M14x1,5	1,50	100	20	15	-	11,0	9,0	12,50	0145	●	●	○					
M15x1	1,00	100	20	10	-	12,0	9,0	14,00	0153	○	○	○					
M16x1	1,00	100	20	10	-	12,0	9,0	15,00	0163	○	○	○					
M16x1,5	1,50	100	20	15	-	12,0	9,0	14,50	0165	●	●	○					
ISO										V _c (m/min)							
P										5-50	5-50	5-60					
M										5-20	5-20	5-30					
K										5-40	5-40	5-60					
N										5-40	5-40	5-60					
S										1-8	1-8	1-8					

1

Основная метрическая резьба ISO DIN-13

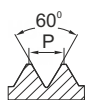

HSS

DIN 2181

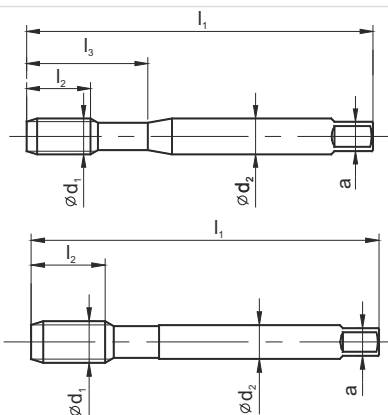

Обрабатываемые материалы



Тип отверстия



Изготовлен из

HSS

Покрытие

Сбег резьбы

~3P

MF d_1	P	l_1	l_2	l_3	d_2	a		Норма	Точность	INDEX
								DIN-2181		
M4x0,5	0,50	45	10	18,0	4,5	3,4	3,5	DIN-2181	ISO2 (6H)	E1-131001
M4,5x0,5	0,50	50	12	22,0	6,0	4,9	4,0	0046	○	
M5x0,5	0,50	52	13	22,0	6,0	4,9	4,5	0051	○	
M5,5x0,5	0,50	56	13	24,0	6,0	4,9	5,0	0056	○	
M6x0,75	0,75	56	14	24,0	6,0	4,9	5,2	0062	●	
M7x0,75	0,75	56	14	-	6,0	4,9	6,2	0072	○	
M8x0,75	0,75	63	14	-	6,0	4,9	7,2	0082	●	
M8x1	1,00	63	17	-	6,0	4,9	7,0	0083	●	
M9x0,75	0,75	63	14	-	7,0	5,5	8,2	0092	○	
M9x1	1,00	63	17	-	7,0	5,5	8,0	0093	○	
M10x0,75	0,75	63	18	-	7,0	5,5	9,2	0102	○	
M10x1	1,00	63	18	-	7,0	5,5	9,0	0103	●	
M10x1,25	1,25	70	22	-	7,0	5,5	8,8	0104	●	
M11x0,75	0,75	63	18	-	8,0	6,2	10,2	0112	○	
M11x1	1,00	63	18	-	8,0	6,2	10,0	0113	○	
M12x1	1,00	70	18	-	9,0	7,0	11,0	0123	●	
M12x1,25	1,25	70	20	-	9,0	7,0	10,8	0124	●	
M12x1,5	1,50	70	20	-	9,0	7,0	10,5	0125	●	
M14x1	1,00	70	18	-	11,0	9,0	13,0	0143	○	
M14x1,25	1,25	70	20	-	11,0	9,0	12,8	0144	●	
M14x1,5	1,50	70	20	-	11,0	9,0	12,5	0145	●	
M15x1	1,00	70	18	-	12,0	9,0	14,0	0153	○	
M15x1,5	1,50	70	20	-	12,0	9,0	13,5	0155	○	
M16x1	1,00	80	18	-	12,0	9,0	15,0	0163	○	
M16x1,25	1,25	80	18	-	18,0	9,0	14,8	0164	○	
M16x1,5	1,50	80	22	-	12,0	9,0	14,5	0165	●	
M17x1	1,00	80	18	-	12,0	9,0	16,0	0173	○	
M17x1,5	1,50	80	22	-	12,0	9,0	15,5	0175	○	
M18x1	1,00	80	18	-	14,0	11,0	17,0	0183	○	
M18x1,5	1,50	80	22	-	14,0	11,0	16,5	0185	●	
M18x2	2,00	80	22	-	14,0	11,0	16,0	0186	○	
M20x1	1,00	80	18	-	16,0	12,0	19,0	0203	○	

● Доступно со склада

○ По запросу

ISO	Vc (m/min)
P	5-20
M	-
K	-
N	-
S	-

Основная метрическая резьба ISO DIN-13

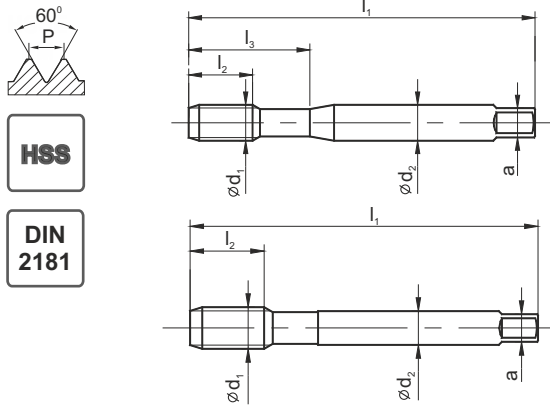

Обрабатываемые материалы



Тип отверстия



Изготовлен из

HSS

Покрытие

Сбег резьбы

~3P

MF d_1	P	l_1	l_2	l_3	d_2	a		Норма					
								DIN-2181	Точность	INDEX			
M20x1,5	1,50	80	22	-	16	12,0	18,5	0205	●				
M20x2	2,00	80	22	-	16	12,0	18,0	0206	○				
M22x1	1,00	80	18	-	18	14,5	21,0	0223	○				
M22x1,5	1,5	80	22	-	18	14,5	20,5	0225	●				
M22x2	2,0	80	22	-	18	14,5	20,0	0226	○				
M24x1	1,0	90	18	-	18	14,5	23,0	0243	○				
M24x1,5	1,5	90	22	-	18	14,5	22,5	0245	●				
M24x2	2,0	90	22	-	18	14,5	22,0	0246	●				
M25x1	1,0	90	18	-	18	14,5	24,0	0253	○				
M25x1,5	1,5	90	22	-	18	14,5	23,5	0255	●				
M25x2	2,0	90	22	-	18	14,5	23,0	0256	○				
M26x1,5	1,5	90	22	-	18	14,5	24,5	0265	●				
M27x1	1,0	90	20	-	20	16,0	26,0	0273	○				
M27x1,5	1,5	90	22	-	20	16,0	25,5	0275	○				
M27x2	2,0	90	22	-	20	16,0	25,0	0276	○				
M28x1	1,0	90	20	-	20	16,0	27,0	0283	○				
M28x1,5	1,5	90	22	-	20	16,0	26,5	0285	○				
M28x2	2,0	90	22	-	20	16,0	26,0	0286	○				
M30x1	1,0	90	22	-	22	18,0	29,0	0303	○				
M30x1,5	1,5	90	22	-	22	18,0	28,5	0305	●				
M30x2	2,0	90	22	-	22	18,0	28,0	0306	○				
M30x3	3,0	125	36	-	22	18,0	27,0	0307	○				
M32x1,5	1,5	90	22	-	22	18,0	30,5	0325	○				
M32x2	2,0	90	22	-	22	18,0	30,0	0326	○				
M33x1,5	1,5	100	25	-	25	20,0	31,5	0335	○				
M33x2	2,0	100	25	-	25	20,0	31,0	0336	○				
M33x3	3,0	125	36	-	25	20,0	30,0	0337	○				
M35x1,5	1,5	100	25	-	28	22,0	33,5	0355	○				
M36x1,5	1,5	100	25	-	28	22,0	34,5	0365	○				
M36x2	2,0	125	36	-	28	22,0	34,0	0366	○				
M36x3	3,0	125	36	-	28	22,0	33,0	0367	○				
M38x1,5	1,5	100	25	-	28	22,0	36,5	0385	○				

● Доступно со склада

○ По запросу

Пример заказа

 E1-131001-0205
 M20x1,5-6H DIN-2181 HSS

ISO	Vc (m/min)			
P	5-20			
M	-			
K	-			
N	-			
S	-			

1

Основная метрическая резьба ISO DIN-13



HSS

DIN 2181

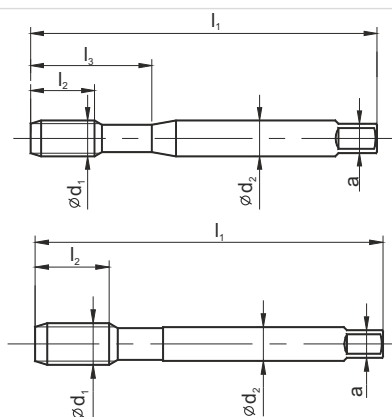

Обрабатываемые материалы



Тип отверстия



Изготовлен из

HSS

Покрытие

Сбег резьбы

~3P

MF d_1	P	l_1	l_2	l_3	d_2	a		Норма					
								DIN-2181					
								Точность	ISO2 (6H)				
INDEX	E1-131001												
M39x1,5	1,5	110	25	-	32	24	37,5	0395	o				
M39x2	2,0	125	36	-	32	24	37,0	0396	o				
M39x3	3,0	125	36	-	32	24	36,0	0397	o				
M40x1,5	1,5	110	25	-	32	24	38,5	0405	o				
M40x2	2,0	125	36	-	32	24	38,0	0406	o				
M40x3	3,0	125	36	-	36	29	37,0	0407	o				
M42x1,5	1,5	110	25	-	36	24	40,5	0425	o				
M42x2	2,0	125	36	-	36	24	40,0	0426	o				
M42x3	3,0	125	36	-	36	24	39,0	0427	o				
M42x4	4,0	150	50	-	36	24	38,0	0428	o				
M45x1,5	1,5	110	25	-	36	29	43,5	0455	o				
M45x2	2,0	125	36	-	36	29	43,0	0456	o				
M45x3	3,0	125	36	-	36	29	42,0	0457	o				
M45x4	4,0	160	50	-	36	29	41,0	0458	o				
M48x1,5	1,5	140	30	-	36	29	46,5	0485	o				
M48x2	2,0	140	36	-	36	29	46,0	0486	o				
M48x3	3,0	140	36	-	40	29	45,0	0487	o				
M48x4	4,0	180	55	-	40	29	44,0	0488	o				
M50x1,5	1,5	140	30	-	40	29	48,5	0505	o				
M50x2	2,0	140	36	-	40	29	48,0	0506	o				
M50x3	3,0	140	36	-	32	29	47,0	0507	o				
M52x1,5	1,5	140	30	-	32	32	50,5	0525	o				
M52x2	2,0	140	36	-	32	32	50,0	0526	o				
M52x3	3,0	140	40	-	32	32	49,0	0527	o				
M52x4	4,0	180	55	-	32	32	48,0	0528	o				

ISO	Vc (m/min)			
P	5-20			
M	-			
K	-			
N	-			
S	-			

Основная метрическая резьба ISO DIN-13					NUTAP					
					Спаянные	Скрученные				
Обрабатываемые материалы										
Тип отверстия										
Изготовлен из					HSSE					
Покрытие					TC					
Сбег резьбы					12P					
M	P	Габаритные размеры		INDEX	NUT TAP					
					По запросу					
M8x1	1,0	По запросу	7,0	0083						
M10x1	1,0		9,0	0103						
M12x1	1,0		11,0	0123						
M12x1,5	1,5		10,5	0125						
M14x1,5	1,5		12,5	0145						
M16x1	1,0		15,0	0163						
M16x1,5	1,5		14,5	0165						
M18x1,5	1,5		16,5	0185						
M20x1,5	1,5		18,5	0205						
M20x2	2,0		18,0	0206						
M22x1,5	1,5		20,5	0225						
M22x2	2,0		20,0	0226						
M24x1,5	1,5		22,5	0245						
M24x2	2,0		22,0	0246						
M27x1,5	1,5		25,5	0275						
M27x2	2,0		25,0	0276						
ISO					Vc (m/min)					
P					5-20	5-20				
M					-	-				
K					-	-				
N					-	-				
S					-	-				

1

Основная метрическая резьба ISO DIN-13



HSS

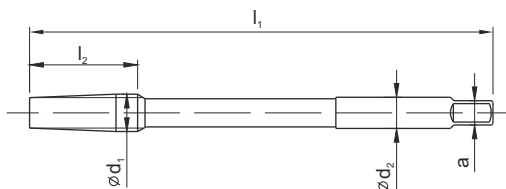

NGMf

LH



LH

Обрабатываемые материалы



Тип отверстия



Изготовлен из

HSS HSS

Покрытие

Сбег резьбы

12P 12P

MF d_1	P	l_1	l_2	d_2	a		Норма	NGMf					
								Точность	ISO2 (6H)				
							INDEX	F1-151001	F1-251001				
M4,5x0,5	0,50	100	10	3,2	2,5	4,0	0046	○	○				
M5x0,5	0,50	110	10	3,6	2,8	4,5	0051	○	○				
M5,5x0,5	0,50	110	10	4,5	3,6	5,0	0056	○	○				
M6x0,75	0,75	120	16	4,5	3,6	5,2	0062	○	○				
M7x0,75	0,75	120	16	5,6	4,5	6,2	0072	○	○				
M8x0,75	0,75	140	16	6,3	5,0	7,2	0082	○	○				
M8x1	1,00	140	20	6,3	5,0	7,0	0083	●	○				
M10x0,75	0,75	160	16	8,0	6,3	9,2	0102	○	○				
M10x1	1,00	160	20	8,0	6,3	9,0	0103	●	○				
M10x1,25	1,25	160	25	8,0	6,3	8,8	0104	●	○				
M12x1	1,00	180	20	9,0	7,1	11,0	0123	●	○				
M12x1,25	1,25	180	25	9,0	7,1	10,8	0124	●	○				
M12x1,5	1,50	180	30	9,0	7,1	10,5	0125	●	○				
M14x1	1,00	180	20	10,0	8,0	13,0	0143	○	○				
M14x1,25	1,25	180	25	10,0	8,0	12,8	0144	●	○				
M14x1,5	1,50	180	30	10,0	8,0	12,5	0145	●	○				
M15x1	1,00	180	20	12,5	10,0	14,0	0153	○	○				
M15x1,5	1,50	180	30	12,5	10,0	13,5	0155	○	○				
M16x1	1,00	200	20	12,5	10,0	15,0	0163	○	○				
M16x1,5	1,50	200	30	12,5	10,0	14,5	0165	●	○				
M17x1	1,00	200	20	14,0	11,2	16,0	0173	○	○				
M17x1,5	1,50	200	30	14,0	11,2	15,5	0175	○	○				
M18x1	1,00	200	20	14,0	11,2	17,0	0183	○	○				
M18x1,5	1,50	200	30	14,0	11,2	16,5	0185	○	○				
M18x2	2,00	200	40	14,0	11,2	16,0	0186	○	○				
M20x1	1,00	220	20	16,0	12,5	19,0	0203	○	○				
M20x1,5	1,50	220	30	16,0	12,5	18,5	0205	●	○				
M20x2	2,00	220	40	16,0	12,5	18,0	0206	○	○				
M22x1	1,00	220	20	18,0	14,0	21,0	0223	○	○				
M22x1,5	1,50	220	30	18,0	14,0	20,5	0225	○	○				
M22x2	2,00	220	40	18,0	14,0	20,0	0226	○	○				
M24x1	1,00	250	20	18,0	14,0	23,0	0243	○	○				

● Доступно со склада

○ По запросу

ISO	Vc (m/min)					
P	5-20	5-20				
M	-	-				
K	6-15	6-15				
N	6-15	6-15				
S	-	-				

Пример заказа

F1-151001-0083
M8x1-6H NGMf HSS

Основная метрическая резьба ISO DIN-13								NGMf							
								LH							
Обрабатываемые материалы															
Тип отверстия															
Изготовлен из								HSS	HSS						
Покрытие															
Сбег резьбы								12P	12P						
MF d ₁	P	l ₁	l ₂	d ₂	a		Норма	NGMf							
							Точность	ISO2 (6H)	ISO2 (6H)						
							INDEX	F1-151001	F1-251001						
M24x1,5	1,50	250	30	18,0	14,0	22,5	0245	o	o						
M24x2	2,00	250	40	18,0	14,0	22,0	0246	o	o						
M25x1	1,00	250	20	20,0	16,0	24,0	0253	o	o						
M25x1,5	1,50	250	30	20,0	16,0	23,5	0255	o	o						
M25x2	2,00	250	40	20,0	16,0	23,0	0256	o	o						
M26x1,5	1,50	250	30	20,0	16,0	24,5	0265	o	o						
M27x1	1,00	250	20	20,0	16,0	26,0	0273	o	o						
M27x1,5	1,50	250	30	20,0	16,0	25,5	0275	o	o						
M27x2	2,00	250	40	20,0	16,0	25,0	0276	o	o						
M28x1	1,00	250	20	22,4	18,0	27,0	0283	o	o						
M28x1,5	1,50	250	30	22,4	18,0	26,5	0285	o	o						
M28x2	2,00	250	40	22,4	18,0	26,0	0286	o	o						
M30x1	1,00	280	20	22,4	18,0	29,0	0303	o	o						
M30x1,5	1,50	280	30	22,4	18,0	28,5	0305	o	o						
M30x2	2,00	280	40	22,4	18,0	28,0	0306	o	o						
M30x3	3,00	280	60	22,4	18,0	27,0	0307	o	o						
M32x1,5	1,50	280	30	25,0	20,0	30,5	0325	o	o						
M32x2	2,00	280	40	25,0	20,0	30,0	0326	o	o						
M33x1,5	1,50	280	30	25,0	20,0	31,5	0335	o	o						
M33x2	2,00	280	40	25,0	20,0	31,0	0336	o	o						
M33x3	3,00	280	60	25,0	20,0	30,0	0337	o	o						
M35x1,5	1,50	280	30	28,0	22,4	33,5	0355	o	o						
M36x1,5	1,50	280	30	28,0	22,4	34,5	0365	o	o						
M36x2	2,00	280	40	28,0	22,4	34,0	0366	o	o						
M36x3	3,00	280	60	28,0	22,4	33,0	0367	o	o						

ISO	Vc (m/min)			
P	5-20	5-20		
M	-	-		
K	6-15	6-15		
N	6-15	6-15		
S	-	-		

1

**Американская унифицированная резьба
UNC, ANSI B-1.1**

MASTER TAP

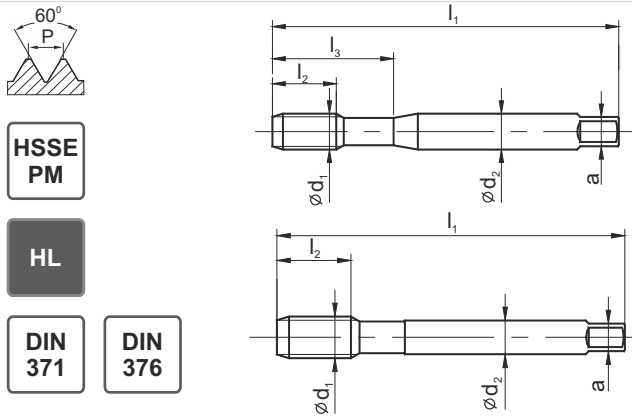

HSSE
PM

HL

DIN
371

DIN
376



Обрабатываемые материалы



Тип отверстия



Изготовлен из

HSSE-PM HSSE-PM

Покрытие

HL HL

Сбег резьбы

B / 4-5P C / 2-3P

UNC	d ₁	1"/P	P	l ₁	l ₂	l ₃	d ₂	a		Норма	DIN-371	
										Точность	2BX	2BX
										INDEX	C4-118M01	C4-528M01
No2-56	2,184	56	0,455	45	10	13	2,8	2,1	1,85	4102	○	○
No4-40	2,844	40	0,635	56	5	18	3,5	2,7	2,35	4104	●	●
No5-40	3,175	40	0,635	56	7	18	3,5	2,7	2,65	4105	●	●
No6-32	3,505	32	0,794	56	6	20	4,0	3,0	2,85	4106	●	●
No8-32	4,165	32	0,794	63	7	21	4,5	3,4	3,50	4108	●	●
No10-24	4,826	24	1,058	70	8	25	6,0	4,9	3,90	4110	●	●
No12-24	5,486	24	1,058	80	10	30	6,0	4,9	4,50	4112	●	●
1/4-20	6,350	20	1,270	80	13	30	7,0	5,5	5,10	4127	●	●
5/16-18	7,938	18	1,411	90	13	35	8,0	6,0	6,60	4128	●	●
3/8-16	9,525	16	1,588	100	15	39	10,0	8,0	8,00	4129	●	●

UNC	d ₁	1"/P	P	l ₁	l ₂	l ₃	d ₂	a		Норма	DIN-376	
										Точность	2BX	2BX
										INDEX	D4-118M01	D4-528M01
7/16-14	11,112	14	1,814	100	15	-	8,0	6,2	9,40	4130	●	●
1/2-13	12,700	13	1,954	110	18	-	9,0	7,0	10,80	4131	●	●
9/16-12	14,288	12	2,117	110	20	-	11,0	9,0	12,20	4132	●	●
5/8-11	15,875	11	2,309	110	22	-	12,0	9,0	13,50	4133	●	●

ISO	Vc (m/min)	
P	5-40	5-40
M	5-15	5-15
K	10-30	10-30
N	10-30	10-30
S	1-8	1-8

MASTER TAP

Пример заказа

C4-118M01-4104
MasterTAP No5-40 UNC 2BX DIN-371 B HSSE-PM HL

● Доступный со склада
○ По запросу

Американская унифицированная резьба UNC, ANSI B-1.1											800X						
											B-TN2	C-R40-TN2					
HSSE TN2 DIN 371 DIN 376																	
Обрабатываемые материалы																	
Тип отверстия																	
Изготовлен из											HSSE						
Покрытие											TN2						
Сбег резьбы											B / 4-5P C / 2-3P						
UNC	d ₁	1"/P	P	l ₁	l ₂	l ₂ R40	l ₃	d ₂	a		Норма	DIN-371					
											Точность	2B	2B				
											INDEX	C2-113X01	C2-513X01				
No2-56	2,184	56	0,455	45	10	10	13	2,8	2,1	1,85	4102	○	○				
No4-40	2,844	40	0,635	56	10	5	18	3,5	2,7	2,35	4104	●	●				
No5-40	3,175	40	0,635	56	10	7	18	3,5	2,7	2,65	4105	●	●				
No6-32	3,505	32	0,794	56	12	6	20	4,0	3,0	2,85	4106	●	●				
No8-32	4,165	32	0,794	63	12	7	21	4,5	3,4	3,50	4108	●	●				
No10-24	4,826	24	1,058	70	14	8	25	6,0	4,9	3,90	4110	●	●				
No12-24	5,486	24	1,058	80	18	10	30	6,0	4,9	4,50	4112	●	●				
1/4-20	6,350	20	1,270	80	18	13	30	7,0	5,5	5,10	4127	●	●				
5/16-18	7,938	18	1,411	90	20	13	35	8,0	6,0	6,60	4128	●	●				
3/8-16	9,525	16	1,588	100	20	15	39	10,0	8,0	8,00	4129	●	●				
UNC	d ₁	1"/P	P	l ₁	l ₂	l ₂ R40	l ₃	d ₂	a		Норма	DIN-376					
											Точность	2B	2B				
											INDEX	D2-113X01	D2-513X01				
7/16-14	11,112	14	1,814	100	22	15	-	8,0	6,2	9,40	4130	●	●				
1/2-13	12,700	13	1,954	110	24	18	-	9,0	7,0	10,80	4131	●	●				
9/16-12	14,288	12	2,117	110	25	20	-	11,0	9,0	12,20	4132	●	●				
5/8-11	15,875	11	2,309	110	32	22	-	12,0	9,0	13,50	4133	●	●				
3/4-10	19,050	10	2,504	125	32	25	-	14,0	11,0	16,50	4135	●	●				
7/8-9	22,225	9	2,822	140	32	30	-	18,0	14,5	19,50	4137	●	●				
1-8	25,400	8	3,175	160	38	30	-	20,0	16,0	22,25	4139	●	●				
1.1/8-7	28,575	7	3,629	180	40	40	-	22,0	18,0	25,00	4141	○	○				
1.1/4-7	31,750	7	3,629	180	40	40	-	22,0	18,0	28,00	4143	○	○				
1.3/8-6	34,925	6	4,233	200	50	40	-	28,0	22,0	30,75	4145	○	○				
1.1/2-6	38,100	6	4,233	200	55	40	-	28,0	22,0	34,00	4147	○	○				
											ISO		Vc (m/min)				
											P	5-35	5-35				
											M	5-15	5-15				
											K	5-25	5-25				
											N	10-30	10-30				
											S	-	-				

**Американская унифицированная резьба
UNC, ANSI B-1.1**

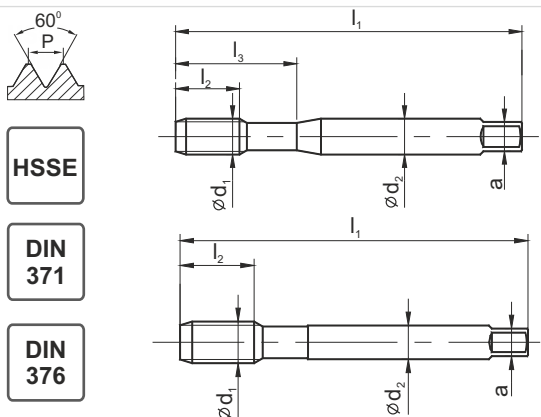

HSSE

DIN 371

DIN 376

800

B

C-R40



Обрабатываемые материалы



Тип отверстия



Изготовлен из

HSSE

HSSE

Покрытие

Сбег резьбы

B / 4-5P

C / 2-3P

UNC	d ₁	1"/P	P	l ₁	l ₂	l ₂ R40	l ₃	d ₂	a		Норма	DIN-371	
											Точность	2B	2B
											INDEX	C2-111101	C2-511101
No2-56	2,184	56	0,455	45	10	10	13	2,8	2,1	1,85	4102	○	○
No4-40	2,844	40	0,635	56	10	5	18	3,5	2,7	2,35	4104	●	●
No5-40	3,175	40	0,635	56	10	7	18	3,5	2,7	2,65	4105	●	●
No6-32	3,505	32	0,794	56	12	6	20	4,0	3,0	2,85	4106	●	●
No8-32	4,165	32	0,794	63	12	7	21	4,5	3,4	3,50	4108	●	●
No10-24	4,826	24	1,058	70	14	8	25	6,0	4,9	3,90	4110	●	●
No12-24	5,486	24	1,058	80	18	10	30	6,0	4,9	4,50	4112	●	●
1/4-20	6,350	20	1,270	80	18	13	30	7,0	5,5	5,10	4127	●	●
5/16-18	7,938	18	1,411	90	20	13	35	8,0	6,0	6,60	4128	●	●
3/8-16	9,525	16	1,588	100	20	15	39	10,0	8,0	8,00	4129	●	●

UNC	d ₁	1"/P	P	l ₁	l ₂	l ₂ R40	l ₃	d ₂	a		Норма	DIN-376	
											Точность	2B	2B
											INDEX	D2-111101	D2-511101
7/16-14	11,112	14	1,814	100	22	15	-	8,0	6,2	9,40	4130	●	●
1/2-13	12,700	13	1,954	110	24	18	-	9,0	7,0	10,80	4131	●	●
9/16-12	14,288	12	2,117	110	25	20	-	11,0	9,0	12,20	4132	●	●
5/8-11	15,875	11	2,309	110	32	22	-	12,0	9,0	13,50	4133	●	●
3/4-10	19,050	10	2,504	125	32	25	-	14,0	11,0	16,50	4135	●	●
7/8-9	22,225	9	2,822	140	32	30	-	18,0	14,5	19,50	4137	●	●
1-8	25,400	8	3,175	160	38	30	-	20,0	16,0	22,25	4139	●	●
1.1/8-7	28,575	7	3,629	180	40	40	-	22,0	18,0	25,00	4141	●	●
1.1/4-7	31,750	7	3,629	180	40	40	-	22,0	18,0	28,00	4143	●	●
1.3/8-6	34,925	6	4,233	200	50	40	-	28,0	22,0	30,75	4145	●	●
1.1/2-6	38,100	6	4,233	200	55	40	-	28,0	22,0	34,00	4147	●	●

ISO	Vc (m/min)	
P	5-20	5-20
M	-	-
K	5-15	5-15
N	5-25	5-25
S	-	-

Пример заказа

C2-111101-4106
800 No5-40 UNC 2B DIN-371 HSSE

● Доступный со склада
○ По запросу

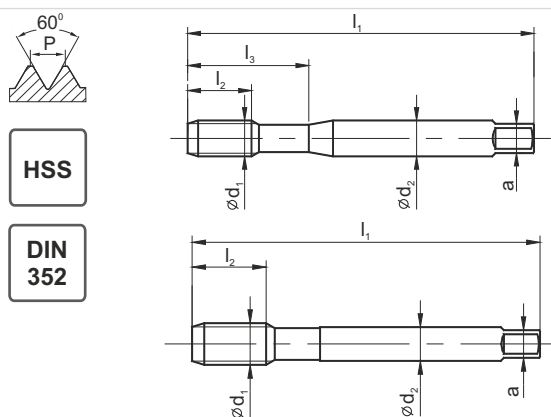
**Американская унифицированная резьба
UNC, ANSI B-1.1**

Обрабатываемые материалы



Тип отверстия



Изготовлен из

HSS

Покрытие

Сбег резьбы

D/-3P

UNC	d_1	1"/P	P	l_1	l_2	l_3	d_2	a		Норма					
										DIN-352					
										Точность	2B				
INDEX	E1-131001														
No4-40	2,844	40	0,635	40	10	18	3,5	2,7	2,35	4104	○				
No5-40	3,175	40	0,640	42	10	18	3,5	2,7	2,65	4105	○				
No6-32	3,505	32	0,794	45	11	18	4,0	3,0	2,85	4106	●				
No8-32	4,166	32	0,794	48	12	23	4,5	3,4	3,50	4108	○				
No10-24	4,826	24	1,060	52	14	26	6,0	4,9	3,90	4110	○				
No12-24	5,486	24	1,060	56	16	27	6,0	4,9	4,50	4112	○				
1/4-20	6,350	20	1,270	56	16	27	6,0	4,9	5,20	4127	●				
5/16-18	7,938	18	1,411	63	20	-	6,0	4,9	6,60	4128	●				
3/8-16	9,525	16	1,588	70	22	-	7,0	5,5	8,00	4129	●				
7/16-14	11,112	14	1,814	70	22	-	8,0	6,2	9,40	4130	○				
1/2-13	12,700	13	1,954	80	25	-	9,0	7,0	10,80	4131	●				
9/16-12	14,288	12	2,117	80	26	-	11,0	9,0	12,20	4132	○				
5/8-11	15,875	11	2,309	80	27	-	12,0	9,0	13,50	4133	●				
3/4-10	19,050	10	2,504	95	30	-	14,0	11,0	16,50	4135	●				
7/8-9	22,225	9	2,822	100	32	-	18,0	14,5	19,50	4137	○				
1-8	25,400	8	3,175	110	36	-	18,0	14,5	22,25	4139	○				
1.1/8-7	28,575	7	3,629	125	40	-	22,0	18,0	25,00	4141	○				
1.1/4-7	31,750	7	3,629	125	40	-	22,0	18,0	28,00	4143	○				
1.3/8-6	34,925	6	4,233	150	50	-	28,0	22,0	30,75	4145	○				
1.1/2-6	38,100	6	4,233	150	50	-	28,0	22,0	34,00	4147	○				
1.3/4-5	44,450	5	5,080	160	58	-	36,0	29,0	39,50	4145	○				
2-4.1/2	50,800	4 1/2	5,644	180	65	-	40,0	32,0	45,00	4155	○				

ISO	Vc (m/min)				
P	5-20				
M	-				
K	-				
N	-				
S	-				

Пример заказа

 E1-131001-4106
 No6-32 UNC 2B DIN-352 HSS

 ● Доступный со склада
 ○ По запросу

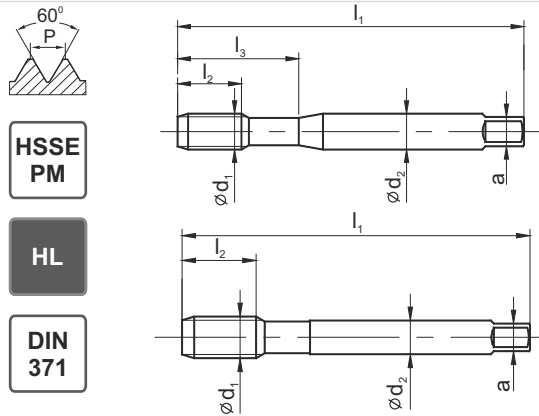
**Американская унифицированная мелкая резьба
UNF, ANSI B-1.1**
MASTER TAP

**HSSE
PM**
HL
**DIN
371**

B-HL

C-R45-HL



Обрабатываемые материалы



Тип отверстия



Изготовлен из

HSSE-PM HSSE-PM

Покрытие

HL HL

Сбег резьбы

B / 4-5P C / 2-3P

UNF	d ₁	1"/P	P	l ₁	l ₂	l ₃	d ₂	a		Норма	DIN-371	
										Точность	2BX	2BX
										INDEX	C4-118M01	C4-528M01
No4-48	2,844	48	0,529	56	5	18	3,5	2,7	2,40	4204	●	●
No5-44	3,175	44	0,557	56	7	18	3,5	2,7	2,70	4205	●	●
No6-40	3,505	40	0,635	56	6	20	4,0	3,0	2,95	4206	●	●
No8-36	4,165	36	0,705	63	7	21	4,5	3,4	3,50	4208	●	●
No10-32	4,826	32	0,794	70	8	25	6,0	4,9	4,10	4210	●	●
No12-28	5,486	28	0,907	80	10	30	6,0	4,9	4,60	4212	●	●
1/4-28	6,350	28	0,907	80	10	30	7,0	5,5	5,50	4227	●	●
5/16-24	7,938	24	1,058	90	13	35	8,0	6,0	6,90	4228	●	●
3/8-24	9,525	24	1,058	100	15	39	10,0	8,0	8,50	4229	●	●

UNF	d ₁	1"/P	P	l ₁	l ₂	l ₃	d ₂	a		Норма	DIN-374	
										Точность	2BX	2BX
										INDEX	D4-118M01	D4-528M01
7/16-20	11,112	20	1,270	100	15	-	8,0	6,2	9,90	4230	●	●
1/2-20	12,700	20	1,270	100	15	-	9,0	7,0	11,50	4231	●	●
9/16-18	14,288	18	1,411	100	15	-	11,0	9,0	12,90	4232	●	●
5/8-18	15,875	18	1,411	100	15	-	12,0	9,0	14,50	4233	●	●

ISO	Vc (m/min)	
P	5-40	5-40
M	5-15	5-15
K	10-30	10-30
N	10-30	10-30
S	1-8	1-8

Пример заказа

C4-118M01-4210
MasterTAP No10-32 UNF 2BX DIN-371 B HSSE-PM HL
 ● Доступный со склада
 ○ По запросу



Американская унифицированная мелкая резьба UNF, ANSI B-1.1											800X									
											B-TN2		C-R40-TN2							
Обрабатываемые материалы																				
Тип отверстия																				
Изготовлен из											HSSE		HSSE							
Покрытие											TN2		TN2							
Сбег резьбы											B / 4-5P		C / 2-3P							
UNF	d ₁	1"/P	P	l ₁	l ₂	l ₂ R40	l ₃	d ₂	a		Норма		DIN-371							
											Точность		2B	2B						
											INDEX		C2-113X01	C2-513X01						
No6-40	3,505	40	0,635	56	12	6	20	4,0	3,0	2,95	4206	○	○							
No8-36	4,165	36	0,705	63	12	7	21	4,5	3,4	3,50	4208	○	○							
No10-32	4,826	32	0,794	70	14	8	25	6,0	4,9	4,10	4210	●	●							
No12-28	5,486	28	0,907	80	18	10	30	6,0	4,9	4,60	4212	●	●							
1/4-28	6,350	28	0,907	80	18	10	30	7,0	5,5	5,50	4227	●	●							
5/16-24	7,938	24	1,058	90	20	13	35	8,0	6,0	6,90	4228	●	●							
3/8-24	9,525	24	1,058	100	20	15	39	10,0	8,0	8,50	4229	●	●							

UNF	d ₁	1"/P	P	l ₁	l ₂	l ₂ R40	l ₃	d ₂	a		Норма		DIN-374					
											Точность		2B	2B				
											INDEX		D2-113X01	D2-513X01				
7/16-20	11,112	20	1,270	100	20	15	-	8,0	6,2	9,90	4230	●	●					
1/2-20	12,700	20	1,270	100	20	15	-	9,0	7,0	11,50	4231	●	●					
9/16-18	14,288	18	1,411	100	20	15	-	11,0	9,0	12,90	4232	●	●					
5/8-18	15,875	18	1,411	100	20	15	-	12,0	9,0	14,50	4233	●	●					
3/4-16	19,050	16	1,588	110	24	17	-	14,0	11,0	17,50	4235	●	●					
7/8-14	22,225	14	1,814	125	24	17	-	18,0	14,5	20,40	4237	●	●					
1-12	25,400	12	2,117	140	27	20	-	18,0	14,5	23,25	4239	●	●					
1.1/8-12	28,575	12	2,117	150	27	22	-	22,0	18,0	26,50	4241	○	○					
1.1/4-12	31,750	12	2,117	150	27	22	-	22,0	18,0	29,50	4243	○	○					
1.3/8-12	34,925	12	2,117	170	30	22	-	28,0	22,0	32,75	4245	○	○					
1.1/2-12	38,100	12	2,117	170	30	24	-	28,0	22,0	36,00	4247	○	○					
ISO											V _c (m/min)							
P											5-35	5-35						
M											5-15	5-15						
K											5-25	10-25						
N											10-30	10-30						
S											-	-						

Пример заказа

 C2-123X01-4208
 800X No8-36 UNF 2B DIN-371 B HSSE TN2

 ● Доступный со склада
 ○ По запросу

1

**Американская унифицированная резьба UNC,
ANSI B-1.1**

HSSE

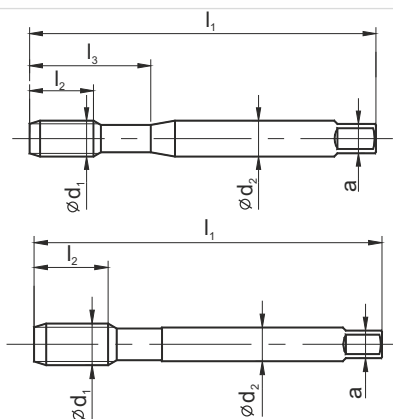
DIN
371DIN
374

800

B

C-R40



Обрабатываемые материалы



Тип отверстия



Изготовлен из

HSSE

HSSE

Покрытие

Сбег резьбы

B / 4-5P

C / 2-3P

UNF	d ₁	1"/P	P	l ₁	l ₂	l ₂ R40	l ₃	d ₂	a		Норма	DIN-371	
											Точность	2B	2B
											INDEX	C2-111101	C2-511101
No6-40	3,505	40	0,635	56	12	6	20	4,0	3,0	2,95	4206	○	○
No8-36	4,165	36	0,705	63	12	7	21	4,5	3,4	3,50	4208	○	○
No10-32	4,826	32	0,794	70	14	8	25	6,0	4,9	4,10	4210	●	●
No12-28	5,486	28	0,907	80	18	10	30	6,0	4,9	4,60	4212	●	●
1/4-28	6,350	28	0,907	80	18	10	30	7,0	5,5	5,50	4227	●	●
5/16-24	7,938	24	1,058	90	20	13	35	8,0	6,0	6,90	4228	●	●
3/8-24	9,525	24	1,058	100	20	15	39	10,0	8,0	8,50	4229	●	●

UNF	d ₁	1"/P	P	l ₁	l ₂	l ₂ R40	l ₃	d ₂	a		Норма	DIN-374	
											Точность	2B	2B
											INDEX	D2-111101	D2-511101
7/16-20	11,112	20	1,270	100	20	15	-	8,0	6,2	9,90	4230	●	●
1/2-20	12,700	20	1,270	100	20	15	-	9,0	7,0	11,50	4231	●	●
9/16-18	14,288	18	1,411	100	20	15	-	11,0	9,0	12,90	4232	●	●
5/8-18	15,875	18	1,411	100	20	15	-	12,0	9,0	14,50	4233	●	●
3/4-16	19,050	16	1,588	110	24	17	-	14,0	11,0	17,50	4235	●	●
7/8-14	22,225	14	1,814	125	24	17	-	18,0	14,5	20,40	4237	●	●
1-12	25,400	12	2,117	140	27	20	-	18,0	14,5	23,25	4239	●	●
1.1/8-12	28,575	12	2,117	150	27	22	-	22,0	18,0	26,50	4241	○	○
1.1/4-12	31,750	12	2,117	150	27	22	-	22,0	18,0	29,50	4243	○	○
1.3/8-12	34,925	12	2,117	170	30	22	-	28,0	22,0	32,75	4245	○	○
1.1/2-12	38,100	12	2,117	170	30	24	-	28,0	22,0	36,00	4247	○	○

ISO	Vc (m/min)	
P	5-20	5-20
M	-	-
K	5-15	5-15
N	5-25	5-25
S	-	-

Пример заказа

C2-111101-4210
800 No10-32 UNF 2B DIN-371 B HSSE● Доступный со склада
○ По запросу

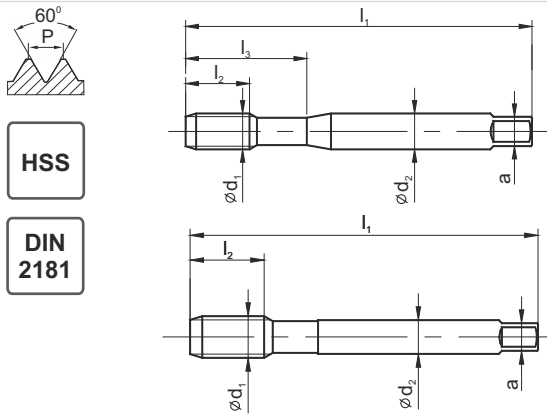
**Американская унифицированная мелкая резьба
UNF, ANSI B-1.1**

Обрабатываемые материалы



Тип отверстия



Изготовлен из

HSS

Покрытие

Сбег резьбы

~3P

UNC	d ₁	1"/P	P	l ₁	l ₂	l ₃	d ₂	a		Норма					
										DIN-2181					
										Точность	2B				
										INDEX	E1-131001				
No5-44	3,175	44	0,577	42	10	18	3,5	2,7	2,70	4205	○				
No6-40	3,505	40	0,635	45	11	18	4,0	3,0	2,95	4206	○				
No8-36	4,165	36	0,705	48	12	23	4,5	3,4	3,50	4208	○				
No10-32	4,826	32	0,794	52	14	22	6,0	4,9	4,10	4210	○				
No12-28	5,486	28	0,907	56	16	24	6,0	4,9	4,60	4212	○				
1/4-28	6,350	28	0,907	56	16	24	6,0	4,9	5,50	4227	●				
5/16-24	7,938	24	1,058	63	17	-	6,0	4,9	6,90	4228	●				
3/8-24	9,525	24	1,058	63	18	-	7,0	5,5	8,50	4229	●				
7/16-20	11,112	20	1,270	70	22	-	8,0	6,2	9,90	4230	●				
1/2-20	12,700	20	1,270	70	20	-	9,0	7,0	11,50	4231	●				
9/16-18	14,288	18	1,411	80	20	-	11,0	9,0	12,90	4232	●				
5/8-18	15,875	18	1,411	80	20	-	12,0	9,0	14,50	4233	●				
3/4-16	16,050	16	1,588	80	22	-	14,0	11,0	17,50	4235	●				
7/8-14	22,225	14	1,814	80	22	-	18,0	14,5	20,40	4237	○				
1-12	25,400	12	2,117	90	22	-	18,0	14,5	23,25	4239	○				
1.1/8-12	28,575	12	2,117	90	22	-	22,0	18,0	26,50	4242	○				
1.1/4-12	31,750	12	2,117	90	22	-	22,0	18,0	29,50	4243	○				
1.3/8-12	34,925	12	2,117	125	36	-	28,0	22,0	32,75	4245	○				
1.1/2-12	38,100	12	2,117	125	36	-	28,0	22,0	36,00	4247	○				

ISO	V _c (m/min)				
P	5-20				
M	-				
K	-				
N	-				
S	-				

Пример заказа

 E1-131001-4227
1/4-28 UNF 2B DIN-2181 HSS

 ● Доступный со склада
○ По запросу

**Американская унифицированная мелкая резьба
UNEF, ANSI B-1.1**

800X



HSSE

TN2

DIN
~374

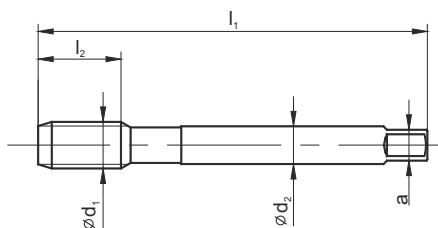

B-TN2 C-R40-TN2



Обрабатываемые материалы



Тип отверстия



Изготовлен из

HSSE HSSE

Покрытие

TN2 TN2

Сбег резьбы

B / 4-5P C / 2-3P

UNEF	d ₁	1"/P	P	l ₁	l ₂	l ₂ R40	l ₃	d ₂	a		Норма	~DIN-374	
											Точность	2B	2B
											INDEX	C2-113X01	C2-513X01
1/4-32	6,350	32	0,794	80	14	8	-	4,5	3,4	5,55	4327	o	o
5/16-32	7,938	32	0,794	80	14	8	-	6,0	4,9	7,15	4328	o	o
3/8-32	9,525	32	0,794	90	18	8	-	7,0	5,5	8,70	4329	o	o
7/16-28	11,112	28	0,907	90	18	10	-	8,0	6,2	10,20	4330	o	o
1/2-28	12,700	28	0,907	100	18	10	-	9,0	7,0	11,80	4331	o	o
9/16-24	14,288	24	1,058	100	18	11	-	11,0	9,0	13,20	4332	o	o
5/8-24	15,875	24	1,058	100	18	11	-	12,0	9,0	14,80	4333	o	o
3/4-20	19,050	20	1,270	110	25	13	-	14,0	11,0	17,80	4335	o	o
7/8-20	22,225	20	1,270	125	25	13	-	18,0	14,5	20,95	4337	o	o
1-20	25,400	20	1,270	140	28	13	-	18,0	14,5	24,15	4339	o	o

ISO	V _c (m/min)		
P	5-35	5-35	
M	5-15	5-15	
K	5-25	10-25	
N	10-30	10-30	
S	-	-	

800X

1



Американская унифицированная мелкая резьба UNEF, ANSI B-1.1											800											
 											B		C-R40									
Обрабатываемые материалы																						
Тип отверстия																						
Изготовлен из											HSSE		HSSE									
Покрытие																						
Сбег резьбы											B / 4-5P		C / 2-3P									
UNEF	d ₁	1"/P	P	l ₁	l ₂	l ₂ R40	l ₃	d ₂	a		Норма		~DIN-374									
											Точность		2B	2B								
											INDEX		C2-111101	C2-511101								
1/4-32	6,350	32	0,794	80	14	8	-	4,5	3,4	5,55	4327	o	o									
5/16-32	7,938	32	0,794	80	14	8	-	6,0	4,9	7,15	4328	o	o									
3/8-32	9,525	32	0,794	90	18	8	-	7,0	5,5	8,70	4329	o	o									
7/16-28	11,112	28	0,907	90	18	10	-	8,0	6,2	10,20	4330	o	o									
1/2-28	12,700	28	0,907	100	18	10	-	9,0	7,0	11,80	4331	o	o									
9/16-24	14,288	24	1,058	100	18	11	-	11,0	9,0	13,20	4332	o	o									
5/8-24	15,875	24	1,058	100	18	11	-	12,0	9,0	14,80	4333	o	o									
3/4-20	19,050	20	1,270	110	25	13	-	14,0	11,0	17,80	4335	o	o									
7/8-20	22,225	20	1,270	125	25	13	-	18,0	14,5	20,95	4337	o	o									
1-20	25,400	20	1,270	140	28	13	-	18,0	14,5	24,15	4339	o	o									
											ISO		V _c (m/min)									
											P	5-20	5-20									
											M	-	-									
											K	5-15	5-15									
											N	5-25	5-25									
											S	-	-									

Трубная резьба Витворта G, DIN-ISO 228

MASTER TAP

HSSE
PM

HL

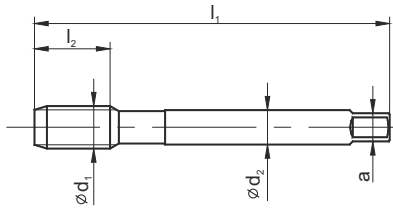
DIN
5156

B-HL C-R45-HL



Обрабатываемые материалы



Тип отверстия



Изготовлен из

HSSE-PM HSSE-PM

Покрытие

HL HL

Сбег резьбы

B / 4-5P C / 2-3P

G	d ₁	1"/P	P	l ₁	l ₂	l ₃	d ₂	a		Норма						
										DIN-5156						
										Точность						
										INDEX	D4-118M01	D4-528M01				
G1/16	7,723	28	0,907	90	10		6,0	4,9	6,80	3121	○	○				
G1/8	9,728	28	0,907	90	10		7,0	5,5	8,80	3123	●	●				
G1/4	13,157	19	1,337	100	14		11,0	9,0	11,80	3127	●	●				
G3/8	16,662	19	1,337	100	15		12,0	9,0	15,25	3129	●	●				
G1/2	20,955	14	1,814	125	17		16,0	12,0	19,00	3131	●	●				
G5/8	22,911	14	1,814	125	20		18,0	14,5	21,00	3133	●	●				
G3/4	26,441	14	1,814	140	20		20,0	16,0	24,50	3035	●	●				
G7/8	30,201	14	1,814	150	22		22,0	18,0	28,25	3137	●	●				
G1	33,249	11	2,309	160	24		25,0	20,0	30,75	3139	●	●				
										ISO		Vc (m/min)				
										P	10-40	10-40				
										M	5-15	5-15				
										K	10-30	10-30				
										N	10-50	10-50				
										S	1-8	1-8				

Трубная резьба Витворта G, DIN-ISO 228										800X					
 										C-TN2	B-TN2	C-R40-TN2			
Обрабатываемые материалы										P M K	P M K	P M K			
Тип отверстия															
Изготовлен из										HSSE	HSSE	HSSE			
Покрытие										TN2	TN2	TN2			
Сбег резьбы										C / 2-3P	B / 4-5P	C / 2-3P			
										Норма			DIN-5156		
										Точность					
										INDEX			D2-123X01	D2-113X01	D2-513X01
G	d ₁	1"/P	P	l ₁	l ₂	l ₂ R40	l ₃	d ₂	a						
G1/16	7,723	28	0,907	90	17	10		6,0	4,9	6,80	3121	○	○	○	
G1/8	9,728	28	0,907	90	18	10		7,0	5,5	8,80	3123	●	●	●	
G1/4	13,157	19	1,337	100	22	14		11,0	9,0	11,80	3127	●	●	●	
G3/8	16,662	19	1,337	100	22	15		12,0	9,0	15,25	3129	●	●	●	
G1/2	20,955	14	1,814	125	25	17		16,0	12,0	19,00	3131	●	●	●	
G5/8	22,911	14	1,814	125	25	20		18,0	14,5	21,00	3133	●	●	●	
G3/4	26,441	14	1,814	140	28	20		20,0	16,0	24,50	3035	●	●	●	
G7/8	30,201	14	1,814	150	30	22		22,0	18,0	28,25	3137	●	●	●	
G1	33,249	11	2,309	160	32	24		25,0	20,0	30,75	3139	●	●	●	
G1.1/8	37,907	11	2,309	170	34	24		28,0	22,0	35,50	3141	○	○	○	
G1.1/4	41,910	11	2,309	170	34	25		32,0	24,0	39,50	3143	○	○	○	
G1.1/2	47,800	11	2,309	190	36	-		36,0	29,0	45,25	3147	○	○	○	
G1.3/4	53,756	11	2,309	190	36	-		40,0	32,0	51,00	3151	○	○	○	
G2	59,614	11	2,309	220	40	-		45,0	35,0	57,00	3155	○	○	○	
										ISO			Vc (m/min)		
										P	5-35	5-35	5-20		
										M	5-15	5-15	5-15		
										K	5-25	10-25	5-15		
										N	10-30	10-30	5-25		
										S	-	-	-		

Трубная резьба Витворта G, DIN-ISO 228

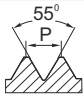

HSSE

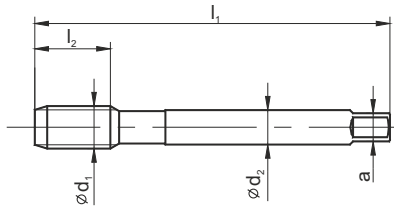
DIN
~5156

800

C

B

C-R40



Обрабатываемые материалы



Тип отверстия



Изготовлен из

HSSE

HSSE

HSSE

Покрытие

Сбег резьбы

C / 2-3P

C / 2-3P

B / 4-5P

G	d ₁	1"/P	P	l ₁	l ₂	l ₂ R40	l ₃	d ₂	a		Норма	DIN-5156						
											Точность							
											INDEX	D2-121101	D2-111101	D2-511101				
G1/16	7,723	28	0,907	90	17	10		6,0	4,9	6,80	3121	○	○	○				
G1/8	9,728	28	0,907	90	18	10		7,0	5,5	8,80	3123	●	●	●				
G1/4	13,157	19	1,337	100	22	14		11,0	9,0	11,80	3127	●	●	●				
G3/8	16,662	19	1,337	100	22	15		12,0	9,0	15,25	3129	●	●	●				
G1/2	20,955	14	1,814	125	25	17		16,0	12,0	19,00	3131	●	●	●				
G5/8	22,911	14	1,814	125	25	20		18,0	14,5	21,00	3133	●	●	●				
G3/4	26,441	14	1,814	140	28	20		20,0	16,0	24,50	3035	●	●	●				
G7/8	30,201	14	1,814	150	30	22		22,0	18,0	28,25	3137	●	●	●				
G1	33,249	11	2,309	160	32	24		25,0	20,0	30,75	3139	●	●	●				
G1.1/8	37,907	11	2,309	170	34	24		28,0	22,0	35,50	3141	○	○	○				
G1.1/4	41,910	11	2,309	170	34	25		32,0	24,0	39,50	3143	○	○	○				
G1.1/2	47,800	11	2,309	190	36	-		36,0	29,0	45,25	3147	○	○	○				
G1.3/4	53,756	11	2,309	190	36	-		40,0	32,0	51,00	3151	○	○	○				
G2	59,614	11	2,309	220	40	-		45,0	35,0	57,00	3155	○	○	○				
												ISO			Vc (m/min)			
												P	5-20	5-20	5-20			
												M	-	-	-			
												K	5-15	5-15	5-15			
												N	5-25	5-25	5-25			
												S	-	-	-			

Пример заказа

D2-121101-3123
800 G-1/8" DIN-5156 C HSSE● Доступный со склада
○ По запросу

Трубная резьба Витворта G, DIN-ISO 228										Ms		
										F		
HSSE DIN ~5157												
Обрабатываемые материалы												
Тип отверстия												
Изготовлен из										HSSE		
Покрытие												
Сбег резьбы										F / 1P		
G	d ₁	1"/P	P	l ₁	l ₂	l ₃	d ₂	a		Норма	~DIN-5157	
										Точность		
										INDEX	E2-141401	
G3/8	16,662	19	1,337	70	22	-	12	9	15,25	3129	●	
G1/2	20,965	14	1,814	80	22	-	16	12	19,00	3131	●	
G3/4	26,441	14	1,814	90	22	-	20	16	24,50	3135	●	
G1	33,259	11	2,309	100	25	-	25	20	30,75	3139	●	
ISO											Vc (m/min)	
P											-	
M											-	
K											-	
N											10-25	
S											-	

1

Трубная резьба Витворта G, DIN-ISO 228

HSS

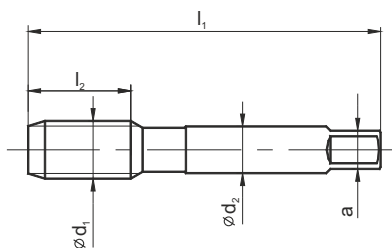
DIN
5157

Обрабатываемые материалы



Тип отверстия



Изготовлен из

HSS

Покрытие

Сбег резьбы

~3P

G	d ₁	1"/P	P	l ₁	l ₂	l ₃	d ₂	a		Норма					
										DIN-5157	Точность				
											INDEX	E1-131001			
G1/16	7,723	28	0,907	56	22	-	6	4,9	6,80	3121	○				
G1/8	9,728	28	0,907	63	20	-	7	5,5	8,80	3123	○				
G1/4	13,157	19	1,337	70	22	-	11	9,0	11,80	3127	●				
G3/8	16,662	19	1,337	70	22	-	12	9,0	15,25	3129	●				
G1/2	20,955	14	1,814	80	22	-	16	12,0	19,00	3131	●				
G5/8	22,911	14	1,814	80	22	-	18	14,5	21,00	3133	○				
G3/4	26,441	14	1,814	90	22	-	20	16,0	24,50	3035	●				
G7/8	30,201	14	1,814	90	22	-	22	18,0	28,25	3137	○				
G1	33,249	11	2,309	100	25	-	25	20,0	30,75	3139	●				
G1.1/8	37,897	11	2,309	125	36	-	28	22,0	35,50	3141	○				
G1.1/4	41,910	11	2,309	125	36	-	32	24,0	39,50	3143	○				
G1.3/8	44,323	11	2,309	125	36	-	36	29,0	41,75	3145	○				
G1.1/2	47,803	11	2,309	140	40	-	36	29,0	45,25	3147	○				
G1.3/4	53,769	11	2,309	140	40	-	40	32,0	51,00	3151	○				
G2	59,614	11	2,309	160	40	-	45	35,0	57,00	3155	○				

ISO	Vc (m/min)			
P	5-20			
M	-			
K	-			
N	-			
S	-			

Пример заказа

E1-131001-3127
G-1/4" DIN-5157 HSS● Доступный со склада
○ По запросу

Трубная резьба Витворта G, DIN-ISO 228											NGRf					
Обрабатываемые материалы																
Тип отверстия																
Изготовлен из											HSS					
Покрытие																
Сбег резьбы											12P					
G	d ₁	1"/P	P	l ₁	l ₂	l ₃	d ₂	a		Норма						
										NGRf						
											Точность					
											INDEX					
G1/16	7,723	28	0,907	140	20	-	6,0	4,5	6,80	3121	○					
G1/8	9,728	28	0,907	140	20	-	7,0	6,3	8,80	3123	○					
G1/4	13,157	19	1,337	180	30	-	11,0	8,0	11,80	3127	○					
G3/8	16,662	19	1,337	200	30	-	12,0	10,0	15,25	3129	○					
G1/2	20,955	14	1,814	220	40	-	16,0	12,5	19,00	3131	●					
G5/8	22,911	14	1,814	220	40	-	18,0	14,0	21,00	3133	○					
G3/4	26,441	14	1,814	250	40	-	20,0	16,0	24,00	3135	○					
G7/8	30,201	14	1,814	280	40	-	22,0	18,0	28,25	3137	○					
G1	33,249	11	2,309	280	60	-	25,0	20,0	30,75	3139	○					
G1.1/8	37,907	11	2,309	280	60	-	28,0	22,4	35,50	3141						
G1.1/4	41,910	11	2,309	280	60	-	32,0	25,0	39,50	3143	○					
G1.3/8	44,323	11	2,309	280	60	-	32,0	25,0	42,00	3145						
G1.1/2	47,800	11	2,309	280	60	-	36,0	28,0	45,00	3147	○					
G1.3/4	53,756	11	2,309	280	60	-	40,0	28,0	51,00	3151						
G2	59,614	11	2,309	280	60	-	45,0	31,5	57,00	3155	○					
											ISO		Vc (m/min)			
											P	5-20				
											M	-				
											K	6-15				
											N	6-15				
											S	-				

1

Трубная резьба Витворта Rp,
PN-ISO 7/1, DIN EN 10226-1



Трубная коническая резьба Витворта Rc,
PN-ISO 7/1, DIN EN 10226-2

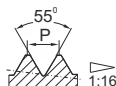

HSSE

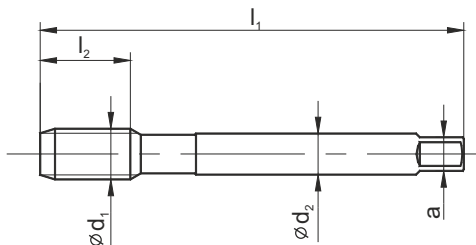
DIN
5156DIN
~5156

800

c

c



Обрабатываемые материалы



Тип отверстия

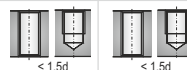

Изготовлен из

HSSE

HSSE

Покрытие

Сбег резьбы

C / 2-3P

C / 2-3P

Rp	d ₁	1"/P	P	l ₁	l ₂	l ₃	d ₂	a		Норма				
										DIN-5156	Точность			
										INDEX	D2-121101			
Rp-1/16"	7,723	28	0,907	90	17	-	6,0	4,9	6,55	3221	o			
Rp-1/8"	9,728	28	0,907	90	18	-	7,0	5,5	8,60	3223	o			
Rp-1/4"	13,157	19	1,337	100	22	-	11,0	9,0	11,50	3227	o			
Rp-3/8"	16,662	19	1,337	100	22	-	12,0	9,0	15,00	3229	o			
Rp-1/2"	20,955	14	1,814	125	25	-	16,0	12,0	18,50	3231	o			
Rp-3/4"	26,441	14	1,814	140	28	-	20,0	16,0	24,00	3235	o			
Rp-1"	33,249	11	2,309	160	32	-	25,0	20,0	30,25	3239	o			

Rc	d ₁	1"/P	P	l ₁	l ₂	l ₃	d ₂	a		Норма	~DIN-5156			
											Точность			
										INDEX	D2-121101			
Rc-1/16"	-	28	0,907	90	17	-	6,0	4,9	6,15	3321	o			
Rc-1/8"	-	28	0,907	90	18	-	7,0	5,5	8,15	3323	•			
Rc-1/4"	-	19	1,337	100	22	-	11,0	9,0	10,85	3327	•			
Rc-3/8"	-	19	1,337	100	22	-	12,0	9,0	14,30	3329	•			
Rc-1/2"	-	14	1,814	125	25	-	16,0	12,0	17,80	3331	o			
Rc-3/4"	-	14	1,814	140	28	-	20,0	16,0	23,20	3335	o			
Rc-1"	-	11	2,309	160	33	-	25,0	20,0	29,20	3339	o			

Конические развертки 1:16 : 157



ISO	V _c (m/min)			
P	5-20	5-20		
M	-	-		
K	5-15	5-15		
N	10-25	10-25		
S	-	-		

Информация о размерах отверстий для конических резьб в технической части каталога, на стр. 269





Американская коническая трубная резьба NPT 1:16, ANSI B-1.20.1										800					
Обрабатываемые материалы															
Тип отверстия															
Изготовлен из										HSSE					
Покрытие															
Сбег резьбы										C / 2-3P					
NPT	d ₁	1"/P	P	l ₁	l ₂	l ₃	d ₂	a		Норма	~DIN-371				
										Точность					
										INDEX	C2-121101				
1/8	-	27	0,94	90	13	33	10,0	8,0	8,50	4623	●				
1/4	-	18	11,411	100	19,5	34,5	14,0	11,0	11,10	4627	●				

Rp	1"/P	P	l ₁	l ₂	l ₃	d ₂	a		Норма	~DIN-374				
									Точность					
									INDEX	D2-121101				
1/8	27	0,941	90	15	-	7	5,5	8,50	4623					
3/8	18	1,411	110	22	-	14,0	11,0	14,40	4629	●				
1/2	14	1,814	140	27	-	18,0	14,5	17,80	4643	●				
3/4	14	1,814	140	28	-	20,0	16,0	23,15	4647	●				
1	11.1/2	2,209	160	35	-	25,0	20,0	29,05	4655	●				

ISO	V _c (m/min)			
P	5-20			
M	-			
K	5-15			
N	10-25			
S	-			

1

**Американская коническая трубная резьба
NPT 1:16, ANSI B-1.20.1**

800

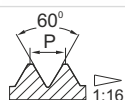

HSSE

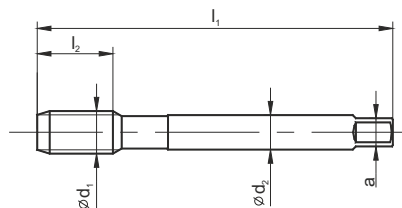
DIN
~374

c



Обрабатываемые материалы



Тип отверстия



Изготовлен из

HSSE

Покрытие

Сбег резьбы

C / 2-3P

NPTF	d ₁	1"/P	P	l ₁	l ₂	d ₂	a		Норма					
									~DIN-374					
									Точность					
									INDEX	D2-121101				
1/8	-	27	0,941	90	15	7,0	5,5	8,45	4723	●				
1/4	-	18	1,411	100	20	11,0	9,0	10,90	4727	○				
3/8	-	18	1,411	110	22	14,0	11,0	14,30	4729	○				
1/2	-	14	1,814	140	27	18,0	14,5	17,60	4731	○				

ISO	V _c (m/min)				
P	5-20				
M	-				
K	5-15				
N	10-25				
S	-				



Американская цилиндрическая трубная резьба NPSF, ANSI B 1.20.3										800									
										c									
										Обрабатываемые материалы									
Тип отверстия										 <math>< 1,5d</math>									
Изготовлен из										HSSE									
Покрытие																			
Сбег резьбы										C / 2-3P									
NPSF	d ₁	1"/P	P	l ₁	l ₂	d ₂	a		Норма	~DIN-5156									
									Точность										
									INDEX	D2-121101									
1/16	7,582	27	0,941	90	17	6,0	4,9	6,35	4521	o									
1/8	9,929	27	0,941	90	18	7,0	5,5	8,70	4523	o									
1/4	13,236	18	1,411	100	22	11,0	9,0	11,30	4527	o									
3/8	16,673	18	1,411	100	22	12,0	9,0	14,75	4529	o									
1/2	20,814	14	1,814	125	25	16,0	12,0	18,20	4531	o									
3/4	26,166	14	1,814	140	28	20,0	16,0	23,50	4535	o									
1	32,718	11.1/2	2,209	160	30	25,0	20,0	29,50	4539	o									
										ISO Vc (m/min)									
										P	5-20								
										M	-								
										K	5-15								
										N	5-25								
										S	-								

1

Резьба витворта (крупный шаг) bsw, bs-84:1956

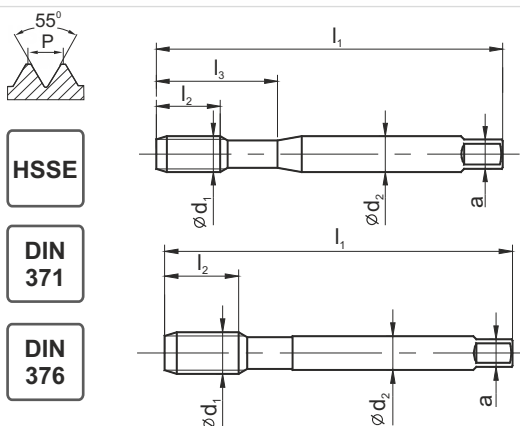

800

B

C-R40



Обрабатываемые материалы



Тип отверстия



Изготовлен из

HSSE

HSSE

Покрытие

Сбег резьбы

B / 4-5P

C / 2-3P

BSW	d ₁	1"/P	P	l ₁	l ₂	l ₂ R40	l ₃	d ₂	a		Норма		Точность		INDEX
											DIN-371(~DIN2182)		нормальный	нормальный	
											C2-111101	C2-511101			
1/8-40	3,175	40	0,635	56	10	5	18	3,5	2,7	2,55	7123	o	o		
3/16-24	4,762	24	1,058	70	14	8	25	6,0	4,9	3,70	7125	o	o		
1/4-20	6,350	20	1,270	80	18	13	30	7,0	5,5	5,10	7127	o	o		
5/16-18	7,938	18	1,411	90	20	20	35	8,0	6,0	6,50	7128	o	o		
3/8-16	9,525	16	1,588	100	21	20	39	10,0	8,0	7,90	7129	o	o		

BSW	d ₁	1"/P	P	l ₁	l ₂	l ₂ R40	l ₃	d ₂	a		Норма		Точность		INDEX
											DIN-376(~DIN2182)		нормальный	нормальный	
											D2-111101	D2-511101			
7/16-14	11,112	14	1,814	100	22	15	-	8,0	6,2	9,25	7130	o	o		
1/2-12	12,700	12	2,117	110	24	18	-	9,0	7,0	10,50	7131	o	o		
5/8-11	15,875	11	2,309	110	32	22	-	12,0	9,0	13,50	7133	o	o		
3/4-10	19,050	10	2,540	125	32	25	-	14,0	11,0	16,40	7135	o	o		
7/8-9	22,225	9	2,822	140	32	30	-	18,0	14,5	19,25	7137	o	o		
1-8	25,400	8	3,175	160	38	30	-	20,0	16,0	22,00	7139	o	o		

ISO	Vc (m/min)	
P	5-20	5-20
M	-	-
K	5-15	5-15
N	5-25	5-25
S	-	-

Пример заказа

C2-111101-7123

Машинные метчики 800 1/8-40 BSW DIN-371 C HSSE

● Доступный со склада

○ По запросу

Основная метрическая резьба iso din-8140-2

 HSSE
PM

HL

 DIN
~371

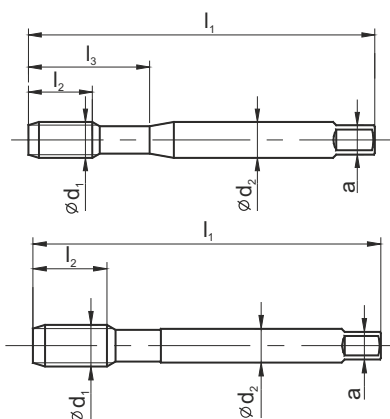
 DIN
~376

MASTER TAP

B-HL

E-R45-HL



Обрабатываемые материалы

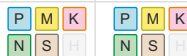

Тип отверстия



Изготовлен из

HSSE-PM HSSE-PM

Покрытие

HL HL

Сбег резьбы

B / 4-5P E / 1,5-2P

EG M (STI)	d ₁	P	l ₁	l ₂	l ₂ R45	l ₃	d ₂	a		Норма ~DIN-371(DIN-40435)		
										Точность	6H mod.	6H mod.
										INDEX	C4-118M01	C4-718M01
M2	2,520	0,40	50	9	5	14	2,8	2,1	2,10	6020	●	●
M2,5	3,084	0,45	56	10	5	18	3,5	2,7	2,65	6025	●	●
M3	3,650	0,50	63	12	5	21	4,5	3,4	3,15	6030	●	●
M4	4,910	0,70	70	14	8	25	6,0	4,9	4,20	6040	●	●
M5	6,040	0,80	80	18	10	30	6,0	4,9	5,25	6050	●	●
M6	7,300	1,00	90	18	10	35	8,0	6,2	6,30	6060	●	●
M8	9,624	1,25	100	20	16	39	10,0	8,0	8,40	6080	●	●

EG M (STI)	d ₁	P	l ₁	l ₂	l ₂ R45	l ₃	d ₂	a		Норма ~DIN-376(DIN-40435)		
										Точность	6H mod.	6H mod.
										INDEX	D4-118M01	D4-528M01
M10	11,948	1,50	100	15	15	-	9,0	7,0	10,50	6100	●	●
M12	14,274	1,75	110	20	20	-	11,0	9,0	12,50	6120	●	●
M14	16,598	2,00	110	20	20	-	12,0	9,0	14,50	6140	●	●
M16	18,598	2,00	125	20	20	-	14,0	11,0	16,50	6160	●	●
M18	21,248	2,50	140	27	27	-	18,0	14,5	18,75	6180	●	●
M20	23,248	2,50	160	30	30	-	18,0	14,5	20,75	6200	●	●

ISO	Vc (m/min)	
P	5-40	5-40
M	5-15	5-15
K	10-30	10-30
N	10-30	10-30
S	1-8	1-8

Пример заказа

 C4-118M01-6030
MasterTAP M3-6H mod. DIN-371 B HSSE-PM HL

- Доступный со склада
- По запросу

1

MASTER TAP

**Американская унифицированная резьба
UNC, ASME B18.29.1**

MASTER TAP

B-HL E-R45-HL

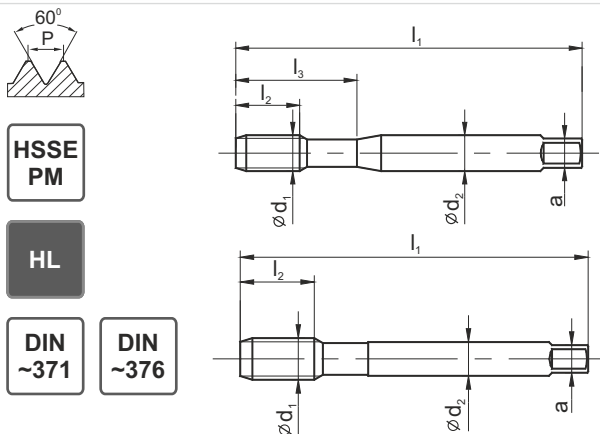

Обрабатываемые материалы



Тип отверстия



Изготовлен из

HSSE-PM HSSE-PM

Покрытие

HL HL

Сбег резьбы

B / 4-5P E / 1,5-2P

EG UNC (STI)	d ₁	P	l ₁	l ₂	l ₂ R45	l ₃	d ₂	a		Норма ~DIN-371(DIN-40435)		
										Точность	2B	2B
										INDEX	C4-118M01	C4-718M01
No4-40	3,671	40	63	13	7	21	4,5	3,4	3,10	6804	o	o
No6-32	4,536	32	70	14	8	25	6,0	4,9	3,80	6806	o	o
No8-32	5,197	32	80	16	10	30	6,0	4,9	4,40	6808	o	o
No10-24	6,200	24	80	17	12	30	7,0	5,5	5,20	6810	o	o
1/4-20	8,002	20	90	20	15	35	8,0	6,2	6,70	6827	o	o
5/16-18	9,771	18	100	22	18	39	10,0	8,0	8,40	6828	o	o

EG UNC (STI)	d ₁	P	l ₁	l ₂	l ₂ R45	l ₃	d ₂	a		Норма ~DIN-376(DIN-40435)		
										Точность	2B	2B
										INDEX	D4-118M01	D4-718M01
3/8-16	11,587	16	100	15	15	-	9	7	10	6829	o	o
7/16-14	13,469	14	110	18	18	-	11	9	11,6	6830	o	o
1/2-13	15,237	13	110	18	18	-	12	9	13,3	6831	o	o
9/16-12	17,039	12	110	20	20	-	12	9	14,9	6832	o	o
5/8-11	18,875	11	125	20	20	-	14	11	16,5	6833	o	o
3/4-10	22,349	10	140	25	25	-	18	14,5	19,75	6835	o	o

ISO	Vc (m/min)	
P	5-40	5-40
M	5-15	5-15
K	10-30	10-30
N	10-30	10-30
S	1-8	1-8

Пример заказа

C4-118M01-6804
MasterTAP No4-40-2B ~DIN-371 B HSSE-PM HL

- Доступный со склада
- По запросу

Американская унифицированная мелкая резьба UNF, ASME B18.29.1											MASTER TAP						
											B-HL	E-R45-HL					
Обрабатываемые материалы																	
Тип отверстия																	
Изготовлен из											HSSE-PM HSSE-PM						
Покрытие											HL HL						
Сбег резьбы											B / 4-5P E / 1,5-2P						
EG UNF (STI)	d ₁	P	l ₁	l ₂	l ₂ R45	l ₃	d ₂	a		Норма	~DIN-371(DIN-40435)						
										Точность	2B	2B					
										INDEX	C4-118M01	C4-718M01					
No4-56	3,533	48	56	9	6	20	4	3	3	6904	o	o					
No6-40	4,330	40	70	10	7	25	6	4,9	3,7	6906	o	o					
No8-36	5,083	36	80	13	9	30	6	4,9	4,4	6908	o	o					
No10-32	5,858	32	80	13	9	30	6	4,9	5,1	6910	o	o					
1/4-28	7,528	28	90	17	10	35	8	6,2	6,6	6927	o	o					
5/16-24	9,312	24	90	18	12	35	10	8	8,3	6928	o	o					
EG UNF (STI)	d ₁	P	l ₁	l ₂	l ₂ R45	l ₃	d ₂	a		Норма	~DIN-376(DIN-40435)						
										Точность	2B	2B					
										INDEX	D4-118M01	D4-718M01					
3/8-24	10,899	24	90	12	12	-	8	6	9,8	6929	o	o					
7/16-20	12,763	20	100	15	15	-	9	7	11,5	6930	o	o					
1/2-20	14,352	20	100	15	15	-	11	9	13,1	6931	o	o					
9/16-18	16,121	18	100	15	15	-	12	9	14,7	6932	o	o					
5/8-18	17,709	18	110	15	15	-	14	11	16,25	6933	o	o					
3/4-16	21,112	16	125	17	17	-	16	12,0	19,5	6935	o	o					
											ISO		Vc (m/min)				
											P	5-40	5-40				
											M	5-15	5-15				
											K	10-30	10-30				
											N	10-30	10-30				
											S	1-8	1-8				

1

Трапецевидная резьба Tr, DIN-103



HSS

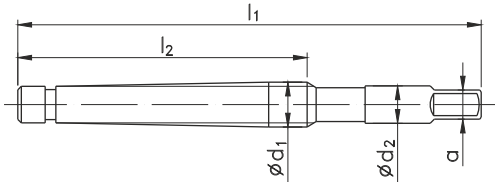

NGSt

LH

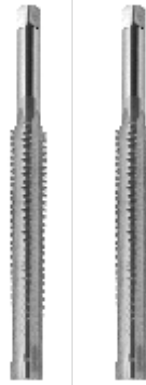

LH

Обрабатываемые материалы



Тип отверстия



Изготовлен из

HSS HSS

Покрытие

- -

Сбег резьбы

24P 24P

Tr d ₁	P	l ₁	l ₂	d ₂	a		Норма	NGSt					
							Точность	7H	7H				
							INDEX	G1-701002	G1-751002				
Tr 10x1,5	1,5	100	45	7	5,5	8,5	8008	○	○				
Tr 10x2	2	115	76	7	5,5	8	8009	●	○				
Tr 12x2	2	120	74	8	6,3	10	8014	●	○				
Tr 12x3	3	155	104	8	6,3	9	8015	●	○				
Tr 14x2	2	130	74	10	8	12	8018	●	○				
Tr 14x3	3	160	104	10	8	11	8019	●	○				
Tr 16x2	2	135	74	11,2	9	14	8022	●	○				
Tr 16x4	4	200	132	11,2	9	12	8024	●	○				
Tr 18x2	2	140	74	12,5	10	16	8030	○	○				
Tr 18x4	4	205	132	12,5	10	14	8032	○	○				
Tr 20x2	2	145	74	14	11,2	18	8033	○	○				
Tr 20x4	4	210	132	14	11,2	16	8034	○	○				
Tr 22x3	3	185	104	16	12,5	19	8035	○	○				
Tr 22x5	5	250	165	16	12,5	17	8037	○	○				
Tr 24x3	3	190	104	18	14	21	8040	○	○				
Tr 24x5	5	255	165	18	14	19	8042	○	○				
Tr 26x3	3	195	104	20	16	23	8045	○	○				
Tr 26x5	5	265	165	20	16	21	8047	○	○				
Tr 28x3	3	205	104	22,4	18	25	8050	○	○				
Tr 28x5	5	270	165	22,4	18	23	8052	○	○				
Tr 30x3	3	205	104	22,4	18	27	8055	○	○				
Tr 30x6	6	305	206	22,4	18	24	8057	○	○				
Tr 32x6	6	315	206	25	20	26	8062	○	○				
Tr 36x6	6	325	206	28	22,4	30	8072	○	○				

ISO	Vc (m/min)					
P	2-6	2-6				
M	-	-				
K	2-6	2-6				
N	2-8	2-8				
S	-	-				

Пример заказа

G1-701002-8009
Tr10x2-7H NGSt HSS● Доступный со склада
○ По запросу

Метчики - раскатники



ТАБЛИЦА ПОДБОРА ИНСТРУМЕНТОВ

4

СТРАНИЦЫ КАТАЛОГА

85-89

M	DIN-371 DIN-376	Раскатники с усиленным хвостовиком Раскатники с переходным хвостовиком	WGN	85
MF	DIN-371 DIN-374	Раскатники с переходным хвостовиком	WGN	86
UNC	DIN-371 DIN-376	Раскатники с переходным хвостовиком	WGN	87
UNF	DIN-371 DIN-374	Раскатники с усиленным хвостовиком Раскатники с переходным хвостовиком	WGN	88
G	~DIN-5156	Раскатники с переходным хвостовиком	WGN	89



Основная метрическая резьба ISO DIN-13										WGN						
										C-TN2	C-SR-TN2	C-SR-TN2	C-SR-TC	E-SR-TC	E-SR-IK-TC	E-SR-IKR-TC
HSSE PM TN2 TC DIN 371 DIN 376										(6GX)						
Обрабатываемые материалы																
Тип отверстия																
Изготовлен из										HSSE-PM HSSE-PM HSSE-PM HSSE-PM HSSE-PM HSSE-PM HSSE-PM						
Покрытие										TN2 TN2 TN2 TC TC TC TC						
Сбег резьбы										C / 2-3P C / 2-3P C / 2-3P C / 2-3P E / 1,5-2P E / 1,5-2P E / 1,5-2P						
M d ₁	P	l ₁	l ₂	l ₃	d ₂	a		норма	DIN-371 (~DIN-2174)							
									Точность	6HX	6HX	6GX	6HX	6HX	6HX	6HX
									INDEX	C4-903005	C4-923005	C4-923006	C4-925005	C4-945005	C4-945055	C4-945065
M 1,6	0,35	40	8	8	2,5	2,1	1,47	0020	●	●	-	-	-	-	-	-
M 2	0,40	45	8	8	2,8	2,1	1,85	0022	●	●	-	-	-	-	-	-
M 2,5	0,45	50	9	9	2,8	2,1	2,33	0025	●	●	-	-	-	-	-	-
M 3	0,50	56	10	18	3,5	2,7	2,80	0030	●	●	●	●	●	-	-	-
M 3,5	0,60	56	12	20	4	3	3,25	0035	○	○	○	○	○	-	-	-
M 4	0,70	63	7	21	4,5	3,4	3,70	0040	●	●	●	●	●	-	-	-
M 5	0,80	70	8	25	6	4,9	4,65	0050	●	●	●	●	●	●	●	●
M 6	1,00	80	10	30	6	4,9	5,60	0060	●	●	●	●	●	●	●	●
M 7	1,00	80	10	30	7	5,5	6,60	0070	○	○	○	○	○	○	○	○
M 8	1,25	90	13	35	8	6,2	7,45	0080	●	●	●	●	●	●	●	●
M 9	1,25	90	13	35	9	7	8,45	0090	○	○	○	○	○	○	○	○
M 10	1,50	100	15	39	10	8	9,35	0100	●	●	●	●	●	●	●	●
M d ₁	P	l ₁	l ₂	l ₃	d ₂	a		норма	DIN-376 (~DIN-2174)							
									Точность	6HX	6HX	6GX				
									INDEX	D4-903005	D4-923005	D4-923006				
M6	1	80	10	-	4,5	3,4	5,60	0060	●	●	●					
M8	1,25	90	13	-	6	4,9	7,45	0080	●	●	●					
M 10	1,5	100	15	-	7	5,5	9,35	0100	●	●	●					
M 12	1,75	110	18	-	9	7	11,25	0120	●	●	●					
M 14	2	110	20	-	11	9	13,10	0140	●	●	●					
M 16	2	110	20	-	12	9	15,10	0160	●	●	●					
M 18	2,5	125	32	-	14	11	16,85	0180	●	●	●					
M 20	2,5	140	32	-	16	12	18,85	0200	●	●	●					
										Vc (m/min)						
ISO										10-30	10-30	10-30				
P										10-30	10-30	10-30				
M										10-25	10-25	10-25				
K										-	-	-				
N										20-40	20-40	20-40				
S										-	-	-				

Мелкая метрическая резьба ISO DIN-13									WGN							
									C-SR-TN2	C-SR-TC						
<div style="display: flex; flex-direction: column; align-items: flex-start;"> <div style="border: 1px solid black; padding: 2px; margin-bottom: 5px;">HSSE PM</div> <div style="border: 1px solid black; padding: 2px; margin-bottom: 5px;">TN2</div> <div style="border: 1px solid black; padding: 2px; margin-bottom: 5px;">TC</div> <div style="border: 1px solid black; padding: 2px; margin-bottom: 5px;">DIN 371</div> <div style="border: 1px solid black; padding: 2px; margin-bottom: 5px;">DIN 374</div> </div>									<div style="display: flex; justify-content: space-around;"> <div style="text-align: center;"> P M K </div> <div style="text-align: center;"> P M K </div> </div>							
Обрабатываемые материалы									<div style="display: flex; justify-content: space-around;"> <div style="text-align: center;"> P M K </div> <div style="text-align: center;"> P M K </div> </div>							
Тип отверстия																
Изготовлен из									HSSE-PM		HSSE-PM					
Покрытие									TN2		TC					
Сбег резьбы									C / 2-3P		C / 2-3P					
MF d ₁	P	l ₁	l ₂	l ₃	d ₂	a		норма	DIN-371							
								Точность	6HX	6HX						
								INDEX	C4-923005	C4-925005						
M 4 x 0,5	0,5	63	7	21	4,5	3,4	3,80	0041	●	●						
M 5 x 0,5	0,5	70	8	25	6	4,9	4,80	0051	●	●						
M 6 x 0,5	0,5	80	10	30	6	4,9	5,80	0061	●	●						
M 6 x 0,75	0,75	80	10	30	7	5,5	5,70	0062	●	●						
M 8 x 1	1	90	13	35	8	6,2	7,60	0083	●	●						
M 10 x 1	1	90	13	35	9	7	9,60	0103	●	●						
M 10 x 1,25	1,25	100	15	39	10	8	9,45	0104	●	●						
MF d ₁	P	l ₁	l ₂	l ₃	d ₂	a		норма	DIN-374 (~DIN-2174)							
								Точность	6HX	6HX						
								INDEX	D4-923005	D4-925005						
M 6 x 0,5	0,5	80	10	-	4,5	3,4	5,80	0061	○	○						
M 6 x 0,75	0,75	80	10	-	4,5	3,4	5,70	0062	○	○						
M 8 x 1	1	90	10	-	6,0	4,9	7,60	0083	●	●						
M 10 x 1	1	90	10	-	7,0	5,5	9,60	0103	●	●						
M 10 x 1,25	1,25	100	15	-	7,0	5,5	9,45	0104	●	●						
M 12 x 1	1	100	10	-	9,0	7	11,60	0123	●	●						
M 12 x 1,25	1,25	100	15	-	9,0	7	11,45	0124	●	●						
M 12 x 1,5	1,5	100	15	-	9,0	7	11,35	0125	●	●						
M 16 x 1,5	1,5	100	15	-	12	9	15,35	0165	●	●						
M 18 x 1,5	1,5	110	17	-	14	11	17,35	0185	●	●						
M 20 x 1,5	1,5	125	17	-	16	12	19,35	0205	●	●						
										V _c (m/min)						
										P	10-30	10-30				
										M	10-25	10-25				
										K	-	-				
										N	20-40	20-60				
										S	-	-				

Американская унифицированная резьба UNC, ANSI B-1.1										WGN						
										C-SR-TN2						
HSSE TN2 DIN 371 DIN 376																
Обрабатываемые материалы																
Тип отверстия																
Изготовлен из										HSSE						
Покрытие										TN2						
Сбег резьбы										C / 2-3P						
										норма		DIN-371 (~DIN-2174)				
UNC	d ₁	1"/P	P	l ₁	l ₂	d ₂	a		Точность	2BX						
										INDEX		C2-923105				
№ 5-40	3,175	40	0,635	56	7	3,5	2,7	2,90	4105	o						
№ 6-32	3,505	32	0,795	56	6	4,0	3,0	3,15	4106	o						
№ 8-32	4,166	32	0,794	63	7	4,5	3,4	3,80	4108	o						
№ 10-24	4,826	24	1,058	70	8	6,0	4,9	4,35	4110	o						
№ 12-24	5,486	24	1,058	80	10	6,0	4,9	5,00	4112	o						
1/4-20	6,350	20	1,270	80	13	7,0	5,5	5,75	4127	o						
5/16-18	7,938	18	1,411	90	13	8,0	6,2	7,30	4128	o						
3/8-16	9,525	16	1,588	100	15	10	8	8,80	4129	o						
										норма		DIN-376 (~DIN-2174)				
UNC	d ₁	1"/P	P	l ₁	l ₂	d ₂	a		Точность	2BX						
										INDEX		D2-923105				
7/16-14	11,112	14	1,814	100	15	8	6,2	10,25	4130	o						
1/2-13	12,700	13	1,954	110	18	9	7	11,80	4131	o						
5/8-11	15,875	11	2,309	110	20	12	9	14,80	4133	o						
										ISO		Vc (m/min)				
										P		10-30				
										M		10-25				
										K		-				
										N		20-40				
										S		-				

Американская унифицированная мелкая резьба UNF, ANSI B-1.1

WGN

C-SR-TN2

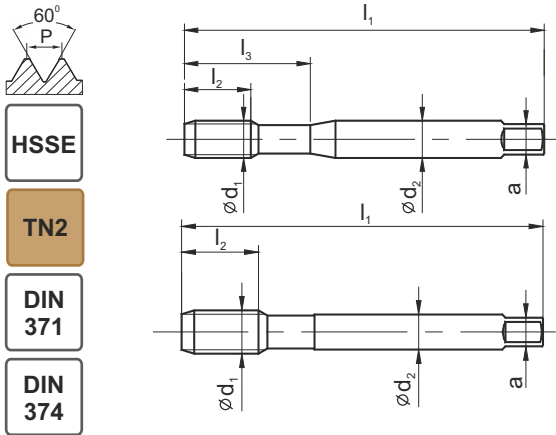

Обрабатываемые материалы



Тип отверстия



Изготовлен из

HSSE

Покрытие

TN2

Сбег резьбы

C / 2-3P

UNF	d ₁	1"/P	P	l ₁	l ₂	d ₂	a		норма							
									DIN-371 (~DIN-2174)	Точность	2BX					
									INDEX	C2-923105						
№ 5-44	3,175	44	0,577	56	7	3,5	2,7	2,92	4205	o						
№ 6-40	3,505	40	0,635	56	6	4	3	3,22	4206	o						
№ 8-36	4,166	36	0,705	63	7	4,5	3,4	3,85	4208	o						
№ 10-32	4,826	32	0,794	70	8	6	4,9	4,45	4210	o						
№ 12-28	5,486	28	0,907	80	10	6	4,9	5,10	4212	o						
1/4-28	6,350	28	0,907	80	10	6	4,9	5,95	4227	o						
5/16-24	7,938	24	1,058	90	13	8	6,2	7,45	4228	o						
3/8-24	9,525	24	1,058	100	15	10	8	9,05	4229	o						

UNF	d ₁	1"/P	P	l ₁	l ₂	d ₂	a		норма							
									DIN-374 (~DIN-2174)	Точность	2BX					
									INDEX	D2-923105						
7/16-20	11,112	20	1,270	100	15	8	6,2	10,55	4230	o						
1/2-20	12,700	20	1,270	110	15	9	7	12,15	4231	o						
5/8-18	15,875	18	1,411	110	15	12	9	15,25	4233	o						
3/4-16	19,050	16	1,588	120	17	14	11	18,35	4235	o						

ISO	Vc (m/min)				
P	10-30				
M	10-25				
K	-				
N	20-40				
S	-				



Трубная резьба Витворта G, DIN-ISO 228										WGN								
										C-SR-TN2								
HSSE TN2 DIN ~5156																		
Обрабатываемые материалы																		
Тип отверстия																		
Изготовлен из										HSSE								
Покрытие										TN2								
Сбег резьбы										C / 2-3P								
										норма ~DIN-5156								
										Точность								
										INDEX D2-923105								
G	d ₁	1"/P	P	l ₁	l ₂	d ₂	a											
G-1/8"	9,728	28	0,907	90	13	7	5,5	9,25	3123	●								
G-1/4"	13,157	19	1,337	100	16	11	9	12,55	3127	●								
G-3/8"	16,662	19	1,337	100	16	12	9	16,05	3129	●								
G-1/2"	20,955	14	1,814	125	18	16	12	20,10	3131	●								
G-5/8"	22,911	14	1,814	125	20	18	14,5	22,05	3133	●								
G-3/4"	26,441	14	1,814	140	22	20	16	25,60	3135	●								
										ISO		V _c (m/min)						
										P		10-30						
										M		10-25						
										K		-						
										N		20-40						
										S		-						

Твердосплавные резьбовые фрезы



Метрическая резьба ISO DIN-13

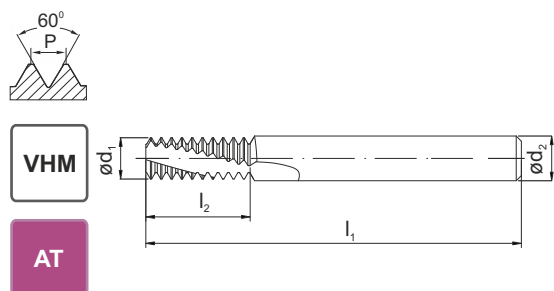

CTM

IK



Изготовлен из



Исполнение

VHM

VHM

Покрытие

AT

AT

P	M	MF	d ₁	d ₂	l ₁	l ₂	z	INDEX	INDEX	INDEX	
0,5	M3	ø ≥ 4	2,2	6	58,0	5,3	3,00	MI-0206053-0050	○	MI-0206053-0050-ИК	○
0,5		ø ≥ 5	3,8	6	58,0	10,3	3,00	MI-0306103-0050	○	MI-0306103-0050-ИК	○
0,7	M4	ø ≥ 5	3,1	6	58,0	7,4	3,00	MI-0306073-0070	○	MI-0306073-0070-ИК	○
0,75		ø ≥ 6	4,5	6	58,0	10,1	3,00	MI-0406103-0075	○	MI-0406103-0075-ИК	○
0,8	M5	ø ≥ 6	3,6	6	58,0	9,2	3,00	MI-0306093-0080	○	MI-0306093-0080-ИК	○
1	M6	ø ≥ 7	4,0	6	58,0	10,5	3,00	MI-0406103-0100	○	MI-0406103-0100-ИК	○
1	M6	ø ≥ 7	4,0	6	58,0	14,5	3,00	MI-0406143-0100	○	MI-0406143-0100-ИК	○
1		ø ≥ 9	6,0	6	58,0	12,5	3,00	MI-0606123-0100	○	MI-0606123-0100-ИК	○
1		ø ≥ 10	8,0	8	64,0	16,5	4,00	MI-0808164-0100	○	MI-0808164-0100-ИК	○
1,25	M8	ø ≥ 10	5,0	6	58,0	14,4	3,00	MI-0506143-0125	○	MI-0506143-0125-ИК	○
1,25	M8	ø ≥ 10	5,0	6	58,0	19,4	3,00	MI-0506193-0125	○	MI-0506193-0125-ИК	○
1,5	M10	ø ≥ 12	7,0	8	64,0	17,3	3,00	MI-0708173-0150	○	MI-0708173-0150-ИК	○
1,5	M10	ø ≥ 12	7,0	8	76,0	24,8	3,00	MI-0708243-0150	○	MI-0708243-0150-ИК	○
1,5		ø ≥ 14	10,0	10	73,0	21,8	4,00	MI-1010214-0150	○	MI-1010214-0150-ИК	○
1,5		ø ≥ 20	16,0	16	105,0	33,8	6,00	MI-1616336-0150	○	MI-1616336-0150-ИК	○
1,75	M12	ø ≥ 14	8,0	8	64,0	20,1	3,00	MI-0808203-0175	○	MI-0808203-0175-ИК	○
1,75	M12	ø ≥ 14	8,0	8	76,0	28,9	3,00	MI-0808283-0175	○	MI-0808283-0175-ИК	○
2	M16	ø ≥ 17	10,0	10	73,0	27,0	3,00	MI-1010273-0200	○	MI-1010274-0200-ИК	○
2	M16	ø ≥ 17	10,0	10	105,0	39,0	3,00	MI-1010393-0200	○	MI-1010393-0200-ИК	○
2		ø ≥ 18	12,0	12	84,0	27,0	4,00	MI-1212274-0200	○	MI-1212273-0200-ИК	○
2		ø ≥ 26	20,0	20	105,0	41,0	6,00	MI-2020416-0200	○	MI-2020416-0200-ИК	○
2,5	M20	ø ≥ 22	14,0	14	84,0	33,8	4,00	MI-1414334-0250	○	MI-1414334-0250-ИК	○
2,5	M20	ø ≥ 22	14,0	14	105,0	48,8	4,00	MI-1414484-0250	○	MI-1414484-0250-ИК	○
3	M24	ø ≥ 25	16,0	16	105,0	40,5	3,00	MI-1616403-0300	○	MI-1616403-0300-ИК	○
3	M24	ø ≥ 25	16,0	16	120,0	58,5	3,00	MI-1616583-0300	○	MI-1616583-0300-ИК	○
3	M27	ø ≥ 28	20,0	20	105,0	43,5	4,00	MI-2020434-0300	○	MI-2020434-0300-ИК	○

ISO	Vc [m/min]	Подача [mm/z]												
		2	3	4	6	8	10	12	14	16	20	25		
P	P1-P5	Конструкционная и цементная сталь	100-250	0,03	0,04	0,04	0,06	0,07	0,08	0,09	0,11	0,12	0,15	0,18
	P6-P9	Углеродистая сталь, низколегированная сталь, литая сталь	110-180	0,02	0,03	0,03	0,05	0,06	0,07	0,08	0,09	0,10	0,12	0,15
	P10-P12	Сталь легированная, Инструментальная сталь, Закаленная сталь до 38 HRC	90-160	0,02	0,02	0,03	0,03	0,04	0,05	0,05	0,06	0,07	0,08	0,10
	P13-P14	Ферритная сталь, мартенситная сталь	60-160	0,02	0,03	0,03	0,04	0,05	0,06	0,06	0,07	0,08	0,09	0,11
M	M1-M3	Аустенитная сталь	60-120	0,02	0,02	0,03	0,03	0,04	0,05	0,05	0,06	0,07	0,08	0,10
K	K1-K6	Чугун серый	70-150	0,03	0,04	0,04	0,06	0,07	0,08	0,09	0,11	0,12	0,15	0,18
N	N1-N4 N7-N9	Алюминиевые сплавы 1% < Si < 7%, Чистая медь, низколегированная медь	150-350	0,03	0,04	0,04	0,06	0,07	0,08	0,09	0,11	0,12	0,15	0,18
	N5, N10	Алюминиевые сплавы Si ≥ 7%	100-250	0,02	0,02	0,03	0,03	0,04	0,05	0,05	0,06	0,07	0,08	0,10
S	S1-S8	Технически чистый титан, Титановые сплавы, Никель, Nickel alloys	20-80	0,02	0,02	0,02	0,03	0,03	0,03	0,03	0,04	0,04	0,04	0,05

Ручные метчики



ТАБЛИЦА ПОДБОРА ИНСТРУМЕНТОВ
5
СТРАНИЦЫ КАТАЛОГА
95-112

M	DIN-352	Комплект ручных метчиков в количестве 3 штук Комплект ручных метчиков в количестве 2 штук Ручной метчик чистовой F		95-97
	DIN-352	Комплект ручных метчиков в количестве 3 штук Ручной метчик чистовой F	INOX	98-99
	~DIN-352	Комплект ручных метчиков в количестве 3 штук Ручной метчик чистовой F	HRC40	100
MF	DIN-2181	Комплект ручных метчиков в количестве 3 штук Ручной метчик чистовой F		101-103
	DIN-2181	Комплект ручных метчиков в количестве 2 штук Ручной метчик чистовой F	HRC40	104
UNC	DIN-352	Комплект ручных метчиков в количестве 3 штук Ручной метчик чистовой F		105
UNF	DIN-2181	Комплект ручных метчиков в количестве 2 штук Ручной метчик чистовой F		106
G	DIN-5157	Комплект ручных метчиков для трубных резьб в количестве 2 штук Ручной метчик чистовой F		107
	DIN-5157	Комплект ручных метчиков для трубных резьб в количестве 2 штук Ручной метчик чистовой F	INOX	108
	DIN-5157	Комплект ручных метчиков для трубных резьб в количестве 2 штук Ручной метчик чистовой F	HRC40	109
BSW	DIN-352	Комплект ручных метчиков в количестве 3 штук Ручной метчик чистовой F		110
BSF	DIN-2181	Комплект ручных метчиков в количестве 3 штук Ручной метчик чистовой F		111
PG	NGSy	Ручные метчики для стальных трубных резьб Ручной метчик чистовой F		112

Основная метрическая резьба ISO DIN-13									KPL/3			KPL/2		F
HSS														
DIN 352														
Обрабатываемые материалы									HSS			HSS		HSS
Тип отверстия														
Изготовлен из									HSS			HSS		HSS
Покрытие														
Сбег резьбы														~2P
M d ₁	P	l ₁	l ₂	l ₃	d ₂	a		норма	DIN-352					
								Точность	ISO1 (4H)					
									INDEX	A1-230002	A1-220002	A1-233002		
M1	0,25	32,5	6,5	10,5	2,5	2,10	0,75	0010	●	-	●			
M1,1	0,25	32,5	6,5	10,5	2,5	2,10	0,85	0011	●	-	●			
M1,2	0,25	32,5	6,5	10,5	2,5	2,10	0,95	0012	●	-	●			
M1,4	0,30	32,5	8,0	10,5	2,5	2,10	1,10	0014	●	-	●			
									Точность	ISO2 (6H)				
									INDEX	A1-230001	A1-220001	A1-233001		
M1,6	0,35	41,0	9,0	10,5	2,5	2,10	1,25	0016	●	-	●			
M1,7	0,35	41,0	9,0	10,5	2,5	2,10	1,35	0017	●	-	●			
M1,8	0,35	41,0	9,0	10,5	2,5	2,10	1,45	0018	●	-	●			
M2	0,40	36,0	10,0	10,0	2,8	2,10	1,60	0020	●	-	●			
M2,2	0,45	36,0	9,0	13,0	2,8	2,10	1,75	0022	●	-	●			
M2,3	0,40	36,0	9,0	13,0	2,8	2,10	1,90	0023	●	-	●			
M2,5	0,45	40,0	9,0	15,0	2,8	2,10	2,05	0025	●	-	●			
M2,6	0,45	40,0	9,0	15,0	2,8	2,10	2,15	0026	●	●	●			
M3	0,50	40,0	11,0	18,0	3,5	2,70	2,50	0030	●	●	●			
M3,5	0,60	45,0	13,0	21,0	4,0	3,00	2,90	0035	●	●	●			
M4	0,70	45,0	13,0	21,0	4,5	3,40	3,30	0040	●	●	●			
M4,5	0,75	50,0	16,0	25,0	6,0	4,90	3,70	0045	●	●	●			
M5	0,80	52,0	16,0	26,0	6,0	4,90	4,20	0050	●	●	●			
M6	1,00	56,0	18,0	27,0	6,0	4,90	5,00	0060	●	●	●			
M7	1,00	56,0	18,0	-	6,0	4,90	6,00	0070	●	●	●			
M8	1,25	63,0	20,0	-	6,0	4,90	6,80	0080	●	●	●			
M9	1,25	63,0	20,0	-	7,0	5,50	7,80	0090	●	●	●			
M10	1,50	70,0	22,0	-	7,0	5,50	8,50	0100	●	●	●			
M11	1,50	70,0	22,0	-	8,0	6,20	9,50	0110	●	●	●			
M12	1,75	80,0	24,0	-	9,0	7,00	10,20	0120	●	●	●			
M14	2,00	80,0	26,0	-	11,0	9,00	12,00	0140	●	●	●			
M16	2,00	80,0	27,0	-	12,0	9,00	14,00	0160	●	●	●			
M18	2,50	95,0	30,0	-	14,0	11,00	15,50	0180	●	●	●			
M20	2,50	95,0	32,0	-	16,0	12,00	17,50	0200	●	●	●			
M22	2,50	100,0	32,0	-	18,0	14,50	19,50	0220	●	●	●			
M24	3,00	110,0	34,0	-	18,0	14,50	21,00	0240	●	●	●			
M27	3,00	110,0	36,0	-	20,0	16,00	24,00	0270	●	●	●			

Основная метрическая резьба ISO DIN-13



HSS

DIN 352

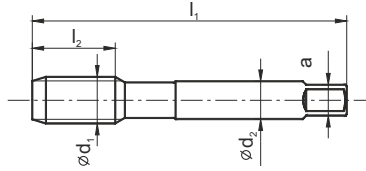

										KPL/3			KPL/2		F	
Обрабатываемые материалы																
Тип отверстия																
Изготовлен из										HSS			HSS		HSS	
Покрытие																
Сбег резьбы															~2P	
M d ₁	P	l ₁	l ₂	l ₃	d ₂	a		Норма	DIN-352							
									Точность	ISO2 (6H)	ISO2 (6H)	ISO2 (6H)				
								INDEX	A1-230001	A1-220001	A1-233001					
M30	3,5	125	40	-	22	18	26,5	0300	●	●	●					
M33	3,5	125	40	-	25	20	29,5	0330	●	●	●					
M36	4,0	150	50	-	28	22	32,0	0360	●	●	●					
M39	4,0	150	50	-	32	24	35,0	0390	●	●	●					
M42	4,5	150	56	-	32	24	37,5	0420	●	●	●					
M45	4,5	160	58	-	36	29	40,5	0450	●	●	●					
M48	5,0	180	65	-	36	29	43,0	0480	●	●	●					
M52	5,0	180	65	-	40	32	47,0	0520	●	●	●					
M56	5,5	180	70	-	40	32	50,5	0560	○	○	○					
M60	5,5	200	70	-	45	35	54,5	0600	○	○	○					
M64	6,0	220	75	-	50	39	58,0	0640	○	○	○					
M68	6,0	220	75	-	50	39	62,0	0680	○	○	○					

Основная метрическая резьба ISO DIN-13



HSS

DIN 352

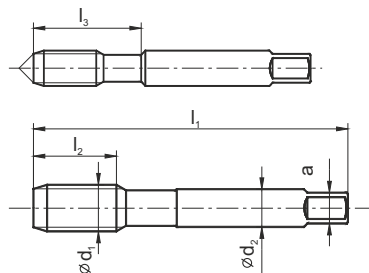

KPL/3-LH

KPL/2-LH

F-LH



Nr1 Nr2 F



Nr1 F



F



Обрабатываемые материалы



Тип отверстия



Изготовлен из

HSS

HSS

HSS

Покрытие

Сбег резьбы

~2P

M d ₁	P	l ₁	l ₂	l ₃	d ₂	a		Норма	DIN-352			
									Точность	ISO2 (6H)	ISO2 (6H)	ISO2 (6H)
									INDEX	A1-270001	A1-260001	A1-273001
M3	0,50	40	11	18	3,5	2,7	2,5	0030	●	●	●	
M3,5	0,60	45	13	21	4,0	3,0	2,9	0035	○	○	○	
M4	0,70	45	13	21	4,5	3,4	3,3	0040	●	●	●	
M4,5	0,75	50	16	25	6,0	4,9	3,7	0045	○	○	○	
M5	0,80	50	16	26	6,0	4,9	4,2	0050	●	●	●	
M6	1,00	56	18	27	6,0	4,9	5,0	0060	●	●	●	
M7	1,00	56	18	-	6,0	4,9	6,0	0070	○	○	○	
M8	1,25	63	20	-	6,0	4,9	6,8	0080	●	●	●	
M9	1,25	63	20	-	7,0	5,5	7,8	0090	○	○	○	
M10	1,50	70	22	-	7,0	5,5	8,5	0100	●	●	●	
M11	1,50	70	22	-	8,0	6,2	9,5	0110	○	○	○	
M12	1,75	80	24	-	9,0	7,0	10,2	0120	●	●	●	
M14	2,00	80	26	-	11,0	9,0	12,0	0140	○	○	○	
M16	2,00	80	27	-	12,0	9,0	14,0	0160	●	●	●	
M18	2,50	95	30	-	14,0	11,0	15,5	0180	○	○	○	
M20	2,50	95	32	-	16,0	12,0	17,5	0200	●	●	●	
M22	2,50	100	32	-	18,0	14,5	19,5	0220	○	○	○	
M24	3,00	110	34	-	18,0	14,5	21,0	0240	○	○	○	
M27	3,00	110	36	-	20,0	16,0	24,0	0270	○	○	○	
M30	3,50	125	40	-	22,0	18,0	26,5	0300	○	○	○	
M33	3,50	125	40	-	25,0	20,0	29,5	0330	○	○	○	
M36	4,00	150	50	-	28,0	22,0	32,0	0360	○	○	○	
M39	4,00	150	50	-	32,0	24,0	35,0	0390	○	○	○	
M42	4,50	150	56	-	32,0	24,0	37,5	0420	○	○	○	
M45	4,50	160	58	-	36,0	29,0	40,5	0450	○	○	○	
M48	5,00	180	65	-	36,0	29,0	43,0	0480	○	○	○	
M52	5,00	180	65	-	40,0	32,0	47,0	0520	○	○	○	
M56	5,50	180	70	-	40,0	32,0	50,5	0560	○	○	○	
M60	5,50	200	70	-	45,0	35,0	54,5	0600	○	○	○	
M64	6,00	220	75	-	50,0	39,0	58,0	0640	○	○	○	
M68	6,00	220	75	-	50,0	39,0	62,0	0680	○	○	○	

4



Пример заказа

 A1-270001-0270
 KPL/3 M27-6H-LH DIN-352 HSS

 ● Доступный со склада
 ○ По запросу

Основная метрическая резьба ISO DIN-13

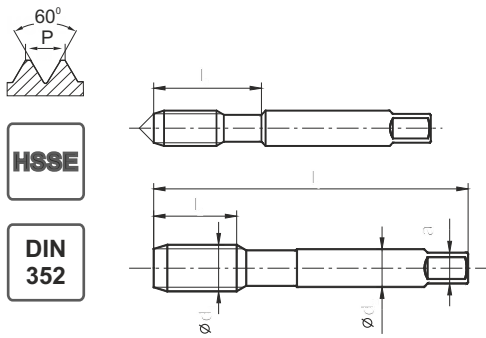

HSSE

DIN 352

INOX

KPL/3-P

F



Nr1-P

Nr2

F

F

Обрабатываемые материалы



Тип отверстия



Изготовлен из

HSSE

HSSE

Покрытие

Сбег резьбы

~3P

M d ₁	P	l ₁	l ₂	l ₃	d ₂	a		Норма	DIN-352		
									Точность	6HX	6HX
									INDEX	A2-235801	A2-203801
M2	0,40	36	10	10	2,8	2,1	1,6	0020	●	●	
M2,5	0,45	40	10	10	2,8	2,1	2,05	0025	●	●	
M3	0,50	40	10	18	3,5	2,7	2,5	0030	●	●	
M3,5	0,60	45	11	20	4,0	3,0	2,9	0035	○	○	
M4	0,70	45	12	21	4,5	3,4	3,3	0040	●	●	
M4,5	0,75	50	13	24	6,0	4,9	3,7	0045	○	○	
M5	0,80	50	14	25	6,0	4,9	4,2	0050	●	●	
M6	1,00	56	16	27	6,0	4,9	5,0	0060	●	●	
M8	1,25	63	22		6,0	4,9	6,8	0080	●	●	
M10	1,50	70	22		7,0	5,5	8,5	0100	●	●	
M12	1,75	75	24		9,0	7,0	10,2	0120	●	●	
M14	2,00	80	32		11,0	9,0	12,0	0140	●	●	
M16	2,00	80	32		12,0	9,0	14,0	0160	●	●	
M18	2,50	95	40		14,0	11,0	15,5	0180	●	●	
M20	2,50	95	40		16,0	12,0	17,5	0200	●	●	
M22	2,50	100	40		18,0	14,5	19,5	0220	●	●	
M24	3,00	110	50		18,0	14,5	21,0	0240	●	●	

Основная метрическая резьба ISO DIN-13									INOX					
 									KPL/3-P		F			
									 Nr1-P		 Nr2		 F	
Обрабатываемые материалы														
Тип отверстия									 < 2,5d		 < 2,5d			
Изготовлен из									HSSE		HSSE			
Покрытие									TN2		TN2			
Сбег резьбы											~3P			
M d ₁	P	l ₁	l ₂	l ₃	d ₂	a	 d	Норма	DIN-352					
								Точность	6HX	6HX				
								INDEX	A2-235831	A2-203831				
M2	0,40	36	10	10	2,8	2,1	1,6	0020	●	●				
M2,5	0,45	40	10	10	2,8	2,1	2,05	0025	●	●				
M3	0,50	40	10	18	3,5	2,7	2,5	0030	●	●				
M3,5	0,60	45	11	20	4,0	3,0	2,9	0035	○	○				
M4	0,70	45	12	21	4,5	3,4	3,3	0040	●	●				
M4,5	0,75	50	13	24	6,0	4,9	3,7	0045	○	○				
M5	0,80	50	14	25	6,0	4,9	4,2	0050	●	●				
M6	1,00	56	16	27	6,0	4,9	5,0	0060	●	●				
M8	1,25	63	22	-	6,0	4,9	6,8	0080	●	●				
M10	1,50	70	22	-	7,0	5,5	8,5	0100	●	●				
M12	1,75	75	24	-	9,0	7,0	10,2	0120	●	●				
M14	2,00	80	32	-	11,0	9,0	12,0	0140	●	●				
M16	2,00	80	32	-	12,0	9,0	14,0	0160	●	●				
M18	2,50	95	40	-	14,0	11,0	15,5	0180	●	●				
M20	2,50	95	40	-	16,0	12,0	17,5	0200	●	●				
M22	2,50	100	40	-	18,0	14,5	19,5	0220	●	●				
M24	3,00	110	50	-	18,0	14,5	21,0	0240	●	●				

Основная метрическая резьба ISO DIN-13									HRC40					
									KPL/3-P		F			
Обрабатываемые материалы														
Тип отверстия														
Изготовлен из									HSSE-PM		HSSE-PM			
Покрытие									TC		TC			
Сбег резьбы											~3P			
M d ₁	P	l ₁	l ₂	l ₃	d ₂	a		Норма	~DIN-352					
								Точность	6HX	6HX				
							INDEX	A4-235D51	A4-203D51					
M3	0,50	40	10	-	3,5	2,7	2,5	0030	●	●				
M4	0,70	50	13	-	6,0	4,9	3,3	0040	●	●				
M5	0,80	50	16	-	6,0	4,9	4,2	0050	●	●				
M6	1,00	56	19	-	6,0	4,9	5,0	0060	●	●				
M8	1,25	63	22	-	6,0	4,9	6,8	0080	●	●				
M10	1,50	70	25	-	7,0	5,5	8,5	0100	●	●				
M12	1,75	75	30	-	9,0	7,0	10,2	0120	●	●				
M16	2,00	80	32	-	12,0	9,0	14,0	0160	●	●				
M20	2,50	95	40	-	16,0	12,0	17,5	0200	○	○				

Комплекты метчиков HRC40 предназначены для обработки сталей с твердостью до 40HRC

Инструкция по правильному применению метчиков HRC40:

1. Максимальная глубина резьбы 1,5xD
2. Соблюдайте правильную последовательность применения метчиков из комплекта
3. Пожалуйста используйте высококачественные СОЖ (например TEREBOR предлагаемый FANARом)
4. Аккуратно удаляйте стружку с поверхности метчика перед каждым следующим применением инструмента
5. Не выкручивайте метчик до того как нарежете всю длину резьбы. Метчик F применяется для коррекции резьбы после закалки деталей, нанесения гальванических покрытий и т.д.

Инструкция по правильному применению метчика F:

1. Пожалуйста очистите резьбовое отверстие от посторонних включений
2. Обработайте резьбу и метчик высококачественными СОЖ (например паста CIMTAP, TEREBOR или машинным маслом)
3. Вставьте метчик в резьбовое отверстие и произведите корректировку резьбы
4. Бережно очистите каждый из метчиков от стружки перед следующим применением



Мелкая метрическая резьба ISO DIN-13



HSS

DIN 2181

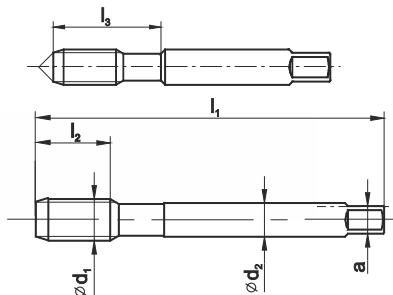

		KPL/2		F	KPL/2-LH		F-LH						
		Nr1	F	F	Nr1	F	F						
Обрабатываемые материалы													
Тип отверстия													
Изготовлен из		HSS	HSS	HSS	HSS	HSS	HSS						
Покрытие													
Сбег резьбы				~2P			~2P						
		DIN-2181											
MF d ₁	P	l ₁	l ₂	l ₃	d ₂	a		Норма	DIN-2181				
									Точность	ISO2 (6H)	ISO2 (6H)	ISO2 (6H)	ISO2 (6H)
									INDEX	A1-220001	A1-222001	A1-260001	A1-261001
M4x0,5	0,50	45	10	18,0	4,5	3,4	3,5	0041	●	●	○	○	
M4,5x0,5	0,50	50	12	22,0	6,0	4,9	4,0	0046	○	○	○	○	
M5x0,5	0,50	52	13	22,0	6,0	4,9	4,5	0051	●	●	○	○	
M5,5x0,5	0,50	56	13	24,0	6,0	4,9	5,0	0056	○	○	○	○	
M6x0,75	0,75	56	14	24,0	6,0	4,9	5,2	0062	●	●	○	○	
M7x0,75	0,75	56	14	-	6,0	4,9	6,2	0072	○	○	○	○	
M8x0,75	0,75	63	14	-	6,0	4,9	7,2	0082	●	●	○	○	
M8x1	1,00	63	17	-	6,0	4,9	7,0	0083	●	●	●	●	
M9x0,75	0,75	63	14	-	7,0	5,5	8,2	0092	○	○	○	○	
M9x1	1,00	63	17	-	7,0	5,5	8,0	0093	○	○	○	○	
M10x0,75	0,75	63	18	-	7,0	5,5	9,2	0102	○	○	○	○	
M10x1	1,00	63	18	-	7,0	5,5	9,0	0103	●	●	●	●	
M10x1,25	1,25	70	22	-	7,0	5,5	8,8	0104	●	●	●	●	
M11x0,75	0,75	63	18	-	8,0	6,2	10,2	0112	○	○	○	○	
M11x1	1,00	63	18	-	8,0	6,2	10,0	0113	○	○	○	○	
M12x1	1,00	70	18	-	9,0	7,0	11,0	0123	●	●	●	●	
M12x1,25	1,25	70	20	-	9,0	7,0	10,8	0124	●	●	●	●	
M12x1,5	1,50	70	20	-	9,0	7,0	10,5	0125	●	●	○	○	
M14x1	1,00	70	18	-	11,0	9,0	13,0	0143	●	●	○	○	
M14x1,25	1,25	70	22	-	11,0	9,0	12,8	0144	●	●	○	○	
M14x1,5	1,50	70	22	-	11,0	9,0	12,5	0145	●	●	●	●	
M15x1	1,00	70	18	-	12,0	9,0	14,0	0153	○	○	○	○	
M15x1,5	1,50	70	22	-	12,0	9,0	13,5	0155	○	○	○	○	
M16x1	1,00	80	18	-	12,0	9,0	15,0	0163	●	●	●	●	
M16x1,25	1,25	80	18	-	12,0	9,0	14,8	0164	○	○	○	○	
M16x1,5	1,50	80	22	-	12,0	9,0	14,5	0165	●	●	○	○	
M17x1	1,00	80	18	-	12,0	9,0	16,0	0173	○	○	○	○	
M17x1,5	1,50	80	22	-	12,0	9,0	15,5	0175	○	○	○	○	
M18x1	1,00	80	18	-	14,0	11,0	17,0	0183	●	●	○	○	
M18x1,5	1,50	80	22	-	14,0	11,0	16,5	0185	●	●	●	●	
M18x2	2,00	80	22	-	14,0	11,0	16,0	0186	●	●	○	○	
M20x1	1,00	80	18	-	16,0	12,0	19,0	0203	●	●	○	○	
M20x1,5	1,50	80	22	-	16,0	12,0	18,5	0205	●	●	●	●	
M20x2	2,00	80	22	-	16,0	12,0	18,0	0206	●	●	○	○	
M22x1	1,00	80	18	-	18,0	14,5	21,0	0223	●	●	○	○	

Пример заказа

 A1-222001-0083
 KPL/2 M8x1-6H DIN-2181 HSS

 ● Доступный со склада
 ○ По запросу

Мелкая метрическая резьба ISO DIN-13



HSS

DIN 2181

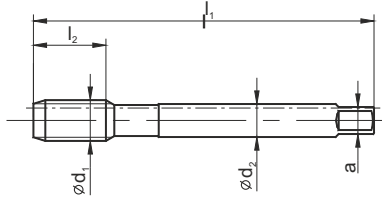

	KPL/2	F	KPL/2-LH	F-LH
Обрабатываемые материалы				
Тип отверстия				
Изготовлен из	HSS	HSS	HSS	HSS
Покрытие				
Сбег резьбы		~2P		~2P

MF d ₁	P	l ₁	l ₂	l ₃	d ₂	a		Норма	DIN-2181				
									Точность	ISO2 (6H)	ISO2 (6H)	ISO2 (6H)	ISO2 (6H)
									INDEX	A1-220001	A1-222001	A1-260001	A1-260001
M22x1,5	1,5	80	22	-	18	14,5	20,5	0225	●	●	●	●	
M22x2	2,0	80	22	-	18	14,5	20,0	0226	●	●	○	○	
M24x1	1,0	90	18	-	18	14,5	23,0	0243	●	●	●	●	
M24x1,5	1,5	90	22	-	18	14,5	22,5	0245	●	●	○	○	
M24x2	2,0	90	22	-	18	14,5	22,0	0246	●	●	○	○	
M25x1	1,0	90	18	-	18	14,5	24,0	0253	○	○	○	○	
M25x1,5	1,5	90	22	-	18	14,5	23,5	0255	○	○	○	○	
M25x2	2,0	90	22	-	18	14,5	23,0	0256	○	○	○	○	
M26x1,5	1,5	90	22	-	18	14,5	24,5	0265	○	○	○	○	
M27x1	1,0	90	22	-	20	16,0	26,0	0273	○	○	○	○	
M27x1,5	1,5	90	22	-	20	16,0	25,5	0275	●	●	○	○	
M27x2	2,0	90	22	-	20	16,0	25,0	0276	●	●	○	○	
M28x1	1,0	90	20	-	20	16,0	27,0	0283	○	○	○	○	
M28x1,5	1,5	90	22	-	20	16,0	26,5	0285	●	●	○	○	
M28x2	2,0	90	22	-	20	16,0	26,0	0286	○	○	○	○	
M30x1	1,0	90	18	-	22	18,0	29,0	0303	○	○	○	○	
M30x1,5	1,5	90	22	-	22	18,0	28,5	0305	●	●	○	○	
M30x2	2,0	90	22	-	22	18,0	28,0	0306	●	●	○	○	
M30x3	3,0	125	36	-	22	18,0	27,0	0307	●	○	○	○	
M32x1,5	1,5	90	22	-	22	18,0	30,5	0325	○	○	○	○	
M32x2	2,0	90	22	-	22	18,0	30,0	0326	○	○	○	○	
M33x1,5	1,5	100	25	-	25	20,0	31,5	0335	●	●	○	○	
M33x2	2,0	100	25	-	25	20,0	31,0	0336	●	●	○	○	
M33x3	3,0	125	36	-	25	20,0	30,0	0337	●	●	○	○	
M35x1,5	1,5	100	25	-	28	22,0	33,5	0355	○	○	○	○	
M36x1,5	1,5	100	25	-	28	22,0	34,5	0365	○	○	○	○	
M36x2	2,0	125	30	-	28	22,0	34,0	0366	○	○	○	○	
M36x3	3,0	125	36	-	28	22,0	33,0	0367	○	○	○	○	
M38x1,5	1,5	100	25	-	28	22,0	36,5	0385	○	○	○	○	
M39x1,5	1,5	110	25	-	32	24,0	37,5	0395	○	○	○	○	
M39x2	2,0	125	30	-	32	24,0	37,0	0396	○	○	○	○	
M39x3	3,0	125	36	-	32	24,0	36,0	0397	○	○	○	○	
M40x1,5	1,5	110	25	-	32	24,0	38,5	0405	○	○	○	○	
M40x2	2,0	125	36	-	32	24,0	38,0	0406	●	●	○	○	
M40x3	3,0	125	36	-	32	24,0	37,0	0407	○	○	○	○	

Пример заказа
A1-220001-0225
KPL/2 M22x1,5-6H DIN-2181 HSS

● Доступный со склада
○ По запросу

Мелкая метрическая резьба ISO DIN-13																	
									KPL/2	F	KPL/2-LH	F-LH					
 									 Nr1 F		 F		 Nr1 F		 F		
Обрабатываемые материалы																	
Тип отверстия									 < 2,5d		 < 2,5d		 < 2,5d		 < 2,5d		
Изготовлен из									HSS		HSS		HSS		HSS		
Покрытие																	
Сбег резьбы											~2P				~2P		
MF d ₁	P	l ₁	l ₂	l ₃	d ₂	a		Норма	DIN-2181								
								Точность	ISO2 (6H)	ISO2 (6H)	ISO2 (6H)	ISO2 (6H)					
									INDEX	A1-220001	A1-222001	A1-260001	A1-262001				
M42x1,5	1,5	110	25	-	32	24	40,5	0425	●	●	○	○					
M42x2	2,0	125	36	-	32	24	40,0	0426	○	○	○	○					
M42x3	3,0	125	36	-	32	24	39,0	0427	●	●	○	○					
M42x4	4,0	150	50	-	32	24	38,0	0428	○	○	○	○					
M45x1,5	1,5	110	25	-	36	29	43,5	0455	●	●	○	○					
M45x2	2,0	125	36	-	36	29	43,0	0456	○	○	○	○					
M45x3	3,0	125	36	-	36	29	42,0	0457	●	●	○	○					
M45x4	4,0	160	50	-	36	29	41,0	0458	○	○	○	○					
M48x1,5	1,5	140	30	-	36	29	46,5	0485	○	○	○	○					
M48x2	2,0	140	36	-	36	29	46,0	0486	○	○	○	○					
M48x3	3,0	140	36	-	36	29	45,0	0487	○	○	○	○					
M48x4	4,0	180	55	-	36	29	44,0	0488	○	○	○	○					
M50x1,5	1,5	140	30	-	36	29	48,5	0505	●	●	○	○					
M50x2	2,0	140	36	-	36	29	48,0	0506	○	○	○	○					
M50x3	3,0	140	36	-	36	29	47,0	0507	●	●	○	○					
M52x1,5	1,5	140	30	-	40	32	50,5	0525	●	●	○	○					
M52x2	2,0	140	36	-	40	32,0	50,00	0526	○	○	○	○					
M52x3	3,0	140	36	-	40	32,0	49,00	0527	●	●	○	○					
M52x4	4,0	180	55	-	40	32,0	48,00	0528	○	○	○	○					

Мелкая метрическая резьба ISO DIN-13

HSSE
PM

TC

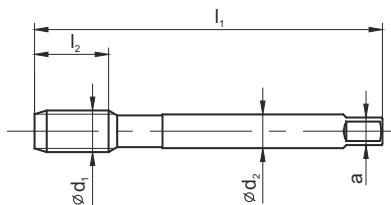
DIN
2181

HRC40

KPL/2

F



Nr1-P

F

F

Обрабатываемые материалы



Тип отверстия



Изготовлен из

HSSE-PM

HSSE-PM

Покрытие

TC

TC

Сбег резьбы

~3P

M d ₁	P	l ₁	l ₂	l ₃	d ₂	a		Норма	DIN-2181	
									Точность	INDEX
M8x1	1,0	63	18	-	6	4,9	7,0	6HX	A4-225D51	A4-202D51
M10x1	1,0	63	18	-	7	5,5	9,0	0103	●	●
M12x1,5	1,5	70	20	-	9	7,0	10,5	0125	●	●
M16x1,5	1,5	70	22	-	12	9,0	14,5	0165	●	●

Комплекты метчиков HRC40 предназначены для обработки сталей с твердостью до 40HRC Инструкция по правильному применению метчиков HRC40:

1. Максимальная глубина резьбы 1,5xD
 2. Соблюдайте правильную последовательность применения метчиков из комплекта
 3. Пожалуйста используйте высококачественные СОЖ (например TEREBOR предлагаемый FANARом)
 4. Аккуратно удаляйте стружку с поверхности метчика перед каждым следующим применением инструмента
 5. Не выкручивайте метчик до того как нарежете всю длину резьбы
- Метчик KAL (Nr2) применяется для коррекции резьбы после закалки деталей, нанесения гальванических покрытий и т.д.**

Инструкция по правильному применению метчика KAL:

1. Пожалуйста очистите резьбовое отверстие от посторонних включений
2. Обработайте резьбу и метчик высококачественными СОЖ (например паста CIMTAP, TEREBOR или машинным маслом)
3. Вставьте метчик в резьбовое отверстие и произведите корректировку резьбы
4. Бережно очистите каждый из метчиков от стружки перед следующим применением

Американская унифицированная резьба UNC, ANSI B-1.1											KPL/3		F	
HSS											Nr1		Nr2	
DIN 352											F		F	
Обрабатываемые материалы														
Тип отверстия														
Изготовлен из											HSS		HSS	
Покрытие														
Сбег резьбы													~2P	
UNC	d_1	1"/P	P	l_1	l_2	l_3	d_2	a		Норма	DIN-352			
										Точность	2B	2B		
										INDEX	A1-230001	A1-233001		
No2-56	2,184	56	0,454	36	10	10	2,8	2,1	1,85	4102	○	○		
No4-40	2,844	40	0,635	40	10	18	3,5	2,7	2,35	4104	●	●		
No5-40	3,175	40	0,640	42	10	18	3,5	2,7	2,65	4105	●	●		
No6-32	3,505	32	0,794	45	11	18	4,0	3,0	2,85	4106	●	●		
No8-32	4,166	32	0,794	48	12	23	4,5	3,4	3,50	4108	●	●		
No10-24	4,826	24	1,058	52	14	26	6,0	4,9	3,90	4110	●	●		
No12-24	5,486	24	1,058	56	16	27	6,0	4,9	4,50	4112	○	○		
1/4-20	6,350	20	1,270	56	16	27	6,0	4,9	5,10	4127	●	●		
5/16-18	7,938	18	1,411	63	20	-	6,0	4,9	6,60	4128	●	●		
3/8-16	9,525	16	1,588	70	22	-	7,0	5,5	8,00	4129	●	●		
7/16-14	11,112	14	1,814	70	22	-	8,0	6,2	9,40	4130	●	●		
1/2-13	12,700	13	1,954	80	25	-	9,0	7,0	10,80	4131	●	●		
9/16-12	14,288	12	2,117	80	26	-	11,0	9,0	12,20	4132	○	○		
5/8-11	15,875	11	2,309	80	27	-	12,0	9,0	13,50	4133	●	●		
3/4-10	19,050	10	2,504	95	30	-	14,0	11,0	16,50	4135	●	●		
7/8-9	22,225	9	2,822	100	32	-	18,0	14,5	19,50	4137	●	●		
1-8	25,400	8	3,175	110	36	-	18,0	14,5	22,25	4139	●	●		
1.1/8-7	28,575	7	3,629	125	40	-	22,0	18,0	25,00	4141	○	○		
1.1/4-7	31,750	7	3,629	125	40	-	22,0	18,0	28,00	4143	○	○		
1.3/8-6	34,925	6	4,233	150	50	-	28,0	22,0	30,75	4145	○	○		
1.1/2-6	38,100	6	4,233	150	50	-	28,0	22,0	34,00	4147	○	○		
1.3/4-5	44,450	5	5,080	160	58	-	36,0	29,0	39,50	4145	○	○		
2-4.1/2	50,800	4 1/2	5,645	180	70	-	40,0	32,0	45,00	4155	○	○		

Американская унифицированная резьба с мелким шагом UNF, ANSI B-1.1

HSS

DIN 2181

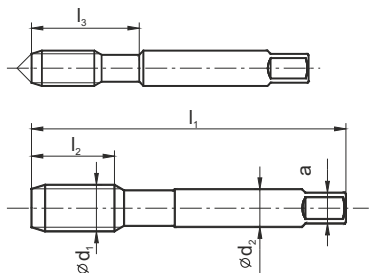

KPL/2

F



Nr1

F

F

Обрабатываемые материалы

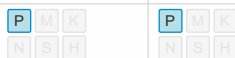

Тип отверстия



Изготовлен из

HSS

HSS

Покрытие

Сбег резьбы

~2P

UNF	d ₁	1"/P	P	l ₁	l ₂	l ₃	d ₂	a		Норма	DIN-2181						
											Точность	2B					2B
											INDEX	A1-220001	A1-222001				
No 5-44	3,175	44	0,577	42	10	18	3,5	2,7	2,70	4205	○	○					
No 6-40	3,505	40	0,635	45	11	18	4,0	3,0	2,95	4206	○	○					
No 8-36	4,166	36	0,705	48	12	23	4,5	3,4	3,50	4208	○	○					
No 10-32	4,826	32	0,794	52	14	22	6,0	4,9	4,10	4210	●	●					
No 12-28	5,486	28	0,907	56	16	24	6,0	4,9	4,60	4212	○	○					
1/4-28	6,350	28	0,907	56	16	24	6,0	4,9	5,50	4227	●	●					
5/16-24	7,938	24	1,058	63	17	-	6,0	4,9	6,90	4228	○	○					
3/8-24	9,525	24	1,058	63	18	-	7,0	5,5	8,50	4229	●	●					
7/16-20	11,112	20	1,270	70	22	-	8,0	6,2	9,90	4230	●	●					
1/2-20	12,700	20	1,270	70	20	-	9,0	7,0	11,50	4231	●	●					
9/16-18	14,288	18	1,411	80	20	-	12,0	9,0	12,90	4232	●	○					
5/8-18	15,875	18	1,411	80	22	-	12,0	9,0	14,50	4233	○	○					
3/4-16	16,050	16	1,588	80	22	-	14,0	11,0	17,50	4235	●	●					
7/8-14	22,225	14	1,814	80	22	-	18,0	14,5	20,40	4237	○	○					
1-12	25,400	12	2,117	90	22	-	18,0	14,5	23,25	4239	●	●					
1.1/8-12	28,575	12	2,117	90	22	-	22,0	18,0	26,50	4242	○	○					
1.1/4-12	31,750	12	2,117	90	22	-	22,0	18,0	29,50	4243	○	○					
1.3/8-12	34,925	12	2,117	125	36	-	28,0	22,0	32,75	4245	○	○					
1.1/2-12	38,100	12	2,117	125	36	-	28,0	22,0	36,00	4247	○	○					

4

Пример заказа

A1-220001-4210
KPL/2 No 10-32 UNF 2B DIN-2128 HSS● Доступный со склада
○ По запросу



Трубная резьба Витворта G, DIN-ISO 228											KPL/2				F		KPL/2-LH		F-LH			
											 Nr1		 F		 F		 Nr1		 F		 F	
HSS											P M K		P M K		P M K		P M K					
DIN 5157											N S H		N S H		N S H		N S H					
Обрабатываемые материалы																						
Тип отверстия											 < 2,5d		 < 2,5d		 < 2,5d		 < 2,5d					
Изготовлен из											HSS		HSS		HSS		HSS					
Покрытие																						
Сбег резьбы													~2P				~2P					
											DIN-5157											
											Норма											
											Точность											
											INDEX											
											A1-220001		A1-222001		A1-260001		A1-262001					
G1/16	7,723	28	0,907	56	22	26	6	4,9	6,80	3121	○	○	○	○								
G1/8	9,728	28	0,907	63	20	27	7	5,5	8,80	3123	●	●	○	○								
G1/4	13,157	19	1,337	70	22	32	11	9,0	11,80	3127	●	●	○	○								
G3/8	16,662	19	1,337	70	22	32	12	9,0	15,25	3129	●	●	●	●								
G1/2	20,955	14	1,814	80	22	35	16	12,0	19,00	3131	●	●	●	●								
G5/8	22,911	14	1,814	80	22	-	18	14,5	21,00	3133	●	●	○	○								
G3/4	26,441	14	1,814	90	22	-	20	16,0	24,50	3135	●	●	●	●								
G7/8	30,201	14	1,814	90	22	-	22	18,0	28,25	3137	●	●	○	○								
G1	33,249	11	2,309	100	25	-	25	20,0	30,75	3139	●	●	●	●								
G1.1/8	37,897	11	2,309	125	36	-	28	22,0	35,50	3141	○	○	○	○								
G1.1/4	41,910	11	2,309	125	36	-	32	24,0	39,50	3143	●	●	○	○								
G1.3/8	44,323	11	2,309	125	36	-	36	29,0	41,75	3145	○	○	○	○								
G1.1/2	47,803	11	2,309	140	40	-	36	29,0	45,25	3147	●	●	○	○								
G1.3/4	53,769	11	2,309	140	40	-	40	32,0	51,00	3151	○	○	○	○								
G2	59,614	11	2,309	160	40	-	45	35,0	57,00	3155	○	○	○	○								

Трубная резьба Витворта G, DIN-ISO 228

INOX

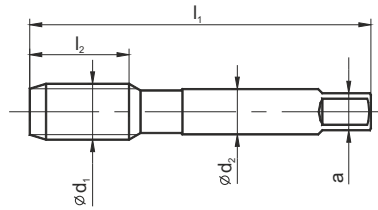
HSSE
PMDIN
5157

Обрабатываемые материалы



Тип отверстия



< 1.5d



< 1.5d

Изготовлен из

HSSE-PM

HSSE-PM

HSSE-PM

Покрытие

Сбег резьбы

4P

3P

G	d ₁	1"/P	P	l ₁	l ₂	d ₂	a		Норма	DIN-5157		
										Точность		
									INDEX	A2-205801	A2-202801	A2-225801
G-1/8"	9,728	28	0,907	63	18	7	5,5	8,8	3123	○	○	○
G-1/4"	13,157	19	1,337	70	22	11	9	11,8	3127	○	○	○
G-3/8"	16,662	19	1,337	70	22	12	9	15,25	3129	○	○	○
G-1/2"	20,955	14	1,814	80	22	16	12	19,0	3131	○	○	○

4

Трубная резьба Витворта G, DIN-ISO 228										HRC40				
										KPL/2	F			
 <div style="display: flex; flex-direction: column; gap: 5px;"> <div style="border: 1px solid black; padding: 2px; width: fit-content;">HSSE PM</div> <div style="border: 1px solid black; padding: 2px; width: fit-content;">TC</div> <div style="border: 1px solid black; padding: 2px; width: fit-content;">DIN 5157</div> </div>										 Nr1 F F				
Обрабатываемые материалы														
Тип отверстия										 < 1,5d	 < 1,5d			
Изготовлен из										HSSE-PM	HSSE-PM			
Покрытие										TC	TC			
Сбег резьбы											~2P			
G	d ₁	1"/P	P	l ₁	l ₂	d ₂	a		Норма	DIN-5157				
									Точность					
									INDEX	A4-225D51	A4-202D51			
G-1/8"	9,728	28	0,907	63	18	7,0	5,5	8,80	3123	●	●			
G-1/4"	13,157	19	1,337	70	22	11,0	9,0	11,80	3127	●	●			
G-3/8"	16,662	19	1,337	70	22	12,0	9,0	15,25	3129	●	●			
G-1/2"	20,955	14	1,814	80	22	16,0	12,0	19,00	3131	●	●			



Комплекты метчиков HRC40 предназначены для обработки сталей с твердостью до 40HRC

Инструкция по правильному применению метчиков HRC40:

1. Максимальная глубина резьбы 1,5xD
 2. Соблюдайте правильную последовательность применения метчиков из комплекта
 3. Пожалуйста используйте высококачественные СОЖ (например TEREBOR предлагаемый FANARом)
 4. Аккуратно удаляйте стружку с поверхности метчика перед каждым следующим применением инструмента
 5. Не выкручивайте метчик до того как нарежете всю длину резьбы
- Метчик F применяется для коррекции резьбы после закалки деталей, нанесения гальванических покрытий и т.д.

Инструкция по правильному применению метчика F:

1. Пожалуйста очистите резьбовое отверстие от посторонних включений
2. Обработайте резьбу и метчик высококачественными СОЖ (например паста CIMTAP, TEREBOR или машинным маслом)
3. Вставьте метчик в резьбовое отверстие и произведите корректировку резьбы
4. Бережно очистите каждый из метчиков от стружки перед следующим применением

**Резьба Витворта (крупный шаг) BSW,
BS-84:1956**

HSS

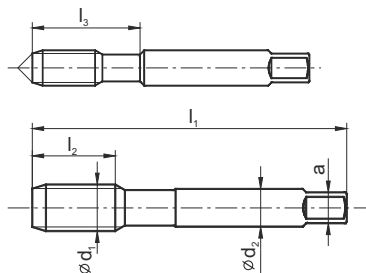
DIN
352

KPL/3

F



Nr1

Nr2

F

F

Обрабатываемые материалы



Тип отверстия



Изготовлен из

HSS

HSS

Покрытие

Сбег резьбы

~2P

BSW	d ₁	1"/P	P	l ₁	l ₂	l ₃	d ₂	a		Норма	DIN-352		
											Точность	нормальный	нормальный
												INDEX	A1-230001
1/8-40	3,180	40	0,635	42	10	18	3,5	2,7	2,55	7123	●	●	
3/16-24	4,760	24	1,058	52	14	26	6	4,9	3,70	7125	●	●	
1/4-20	6,35	20	1,270	56	16	27	6	4,9	5,10	7127	●	●	
5/16-18	7,938	18	1,411	63	20	-	6	4,9	6,50	7128	○	○	
3/8-16	9,525	16	1,588	70	22	-	7	5,5	7,90	7129	●	●	
7/16-14	11,112	14	1,814	70	22	-	8	6,2	9,25	7130	○	○	
1/2-12	12,7	12	2,117	80	25	-	9	7,0	10,50	7131	●	●	
9/16-12	14,288	12	2,117	80	26	-	11	9,0	12,00	7132	○	○	
5/8-11	15,875	11	2,309	80	27	-	12	9,0	13,50	7133	○	○	
3/4-10	19,050	10	2,504	95	30	-	14	11,0	16,40	7135	●	●	
7/8-9	22,225	9	2,822	100	32	-	18	14,5	19,25	7137	○	○	
1-8	25,400	8	3,175	110	36	-	18	14,5	22,00	7139	●	●	
1.1/8-7	28,575	7	3,629	125	40	-	22	18,0	24,75	7141	○	○	
1.1/4-7	31,750	7	3,629	125	40	-	22	18,0	27,75	7143	○	○	
1.1/2-6	38,100	6	4,233	150	50	-	28	22,0	33,50	7147	○	○	
1.3/4-5	44,450	5	5,080	160	58	-	36	29,0	39,00	7151	○	○	
2-4.1/2	50,800	4 1/2	5,645	180	70	-	40	32,0	44,50	7155	○	○	

4

Пример заказа

A1-230001-7123
KPL/3 1/8-40 BSW DIN-352 HSS● Доступный со склада
○ По запросу



Резьба Витворта, (мелкий шаг) BSF, BS-84:1956											KPL/2		F					
											 Nr1		 F					
HSS																		
DIN 2181																		
Обрабатываемые материалы																		
Тип отверстия											 < 2,5d		 < 2,5d					
Изготовлен из											HSS		HSS					
Покрытие																		
Сбег резьбы													~2P					
BSF	d ₁	1"/P	P	l ₁	l ₂	l ₃	d ₂	a		Норма	DIN-2181							
											Точность	нормальный	нормальный					
												INDEX	A1-220001	A1-222001				
3/16-32	4,762	32	0,794	50	14	25	6	4,9	4,00	7225	●	●						
1/4-26	6,350	26	0,977	56	14	21	6	4,9	5,30	7227	●	●						
5/16-22	7,937	22	1,155	63	19	-	6	4,9	6,80	7228	○	○						
3/8-20	9,525	20	1,270	70	20	-	7	5,5	8,30	7229	●	●						
7/16-18	11,112	18	1,411	70	20	-	8	6,2	9,70	7230	○	○						
1/2-16	12,700	16	1,588	70	20	-	9	7,0	11,10	7231	●	●						
9/16-16	14,288	16	1,588	80	20	-	12	9,0	12,70	7232	○	○						
5/8-14	15,875	14	1,814	80	27	-	12	9,0	14,00	7233	○	○						
3/4-12	19,050	12	2,117	80	22	-	14	11,0	16,75	7235	●	●						
7/8-11	22,225	11	2,309	80	22	-	18	14,5	19,75	7237	○	○						
1-10	25,400	10	2,504	110	36	-	18	14,5	22,75	7239	●	●						

Трубная резьба Pg, DIN-40430

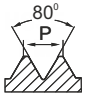

HSS

NGSy

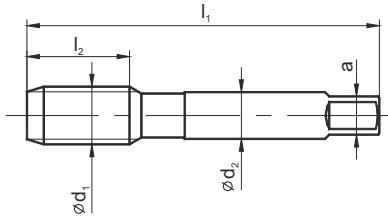

KPL/2

F



Nr1

F

F

Обрабатываемые материалы



Тип отверстия



Изготовлен из

HSS

HSS

Покрытие

Сбег резьбы

~2P

Pg	d ₁	1"/P	P	l ₁	l ₂	l ₃	d ₂	a		Норма	NGSy					
											Точность	INDEX				
Pg7	12,5	20	1,270	65	18	-	9,0	7,1	11,35	8807	●	●				
Pg9	15,2	18	1,411	70	20	-	12,5	10,0	13,95	8809	●	●				
Pg11	18,6	18	1,411	75	22	-	16,0	12,5	17,35	8811	●	●				
Pg13,5	20,4	18	1,411	80	22	-	18,0	14,0	19,15	8813	●	●				
Pg16	22,5	18	1,411	85	22	-	20,0	16,0	21,25	8816	●	●				
Pg21	28,3	16	1,588	95	25	-	25,0	20,0	26,95	8821	●	●				
Pg29	37,0	16	1,588	105	28	-	31,5	25,0	35,60	8829	●	●				
Pg36	47,0	16	1,588	120	32	-	40,0	31,5	45,60	8836	○	○				
Pg42	54,0	16	1,588	130	36	-	40,0	31,5	52,60	8842	○	○				

Резьба Pg заменена мелкой метрической MF согласно DIN EN 60423, изготавливается под заказ



КРУГЛЫЕ ПЛАШКИ



ТАБЛИЦА ПОДБОРА ИНСТРУМЕНТОВ

6

СТРАНИЦЫ КАТАЛОГА

115-125

M	DIN-EN 22568	<i>800</i> <i>800</i> SPN <i>Ms</i> <i>INOX</i>	115
MF	DIN-EN 22568	<i>800</i> <i>800</i> SPN <i>Ms</i> <i>INOX</i>	116-118
UNC	DIN-EN 22568	<i>800</i>	119
UNF	DIN-EN 22568	<i>800</i>	120
G	DIN-EN 24231	<i>800</i> <i>Ms</i> <i>INOX</i>	121
R	DIN-EN 24230	<i>800</i>	122
BSW	DIN-EN 22568	<i>800</i>	123
BSF	DIN-EN 22568	<i>800</i>	124
NPT	DIN-EN 24230	<i>800</i>	125

Основная метрическая резьба ISO DIN-13						800	800	800 SPN	Ms	INOX	
*SPN - Подточка передней поверхности											
Материал						P M K N S H	P M K N S H	P M K N S H	P M K N S H	P M K N S H	
Исполнение							LH	SPN*		SPN	
Изготовлена из						HSS	HSS	HSS	HSS	HSSE	
Сбег резьбы						1,75P	1,75P	1,75P	1,25P	2,25P	
M d ₁	P	DxE	W		норма	DIN-EN 22 568					
						Точность	6g	6g	6g	6g	6g
						INDEX	N1-121001	N1-111001	N1-141001	N1-164001	N2-188001
M 1	0,25	16 x 5	3	0,96	0010	●	-	-	-	-	
M 1,1	0,25	16 x 5	3	1,05	0011	●	-	-	-	-	
M 1,2	0,25	16 x 5	3	1,15	0012	●	-	-	-	-	
M 1,4	0,3	16 x 5	3	1,35	0014	●	-	-	-	-	
M 1,6	0,35	16 x 5	3	1,55	0016	●	-	-	-	-	
M 1,8	0,35	16 x 5	3	1,75	0018	●	-	-	-	-	
M 2	0,4	16 x 5	3	1,95	0020	●	-	-	-	-	
M 2,2	0,45	16 x 5	3	2,15	0022	●	-	-	-	-	
M 2,5	0,45	16 x 5	3	2,42	0025	●	-	-	-	-	
M 3	0,5	20 x 5	3	2,92	0030	●	●	●	●	●	
M 3,5	0,6	20 x 5	3	3,41	0035	●	○	●	○	○	
M 4	0,7	20 x 5	3	3,90	0040	●	●	●	●	●	
M 4,5	0,75	20 x 7	3	4,40	0045	●	○	●	○	○	
M 5	0,8	20 x 7	3	4,90	0050	●	●	●	●	●	
M 6	1	20 x 7	4	5,88	0060	●	●	●	●	●	
M 7	1	25 x 9	4	6,88	0070	●	○	●	○	○	
M 8	1,25	25 x 9	4	7,86	0080	●	●	●	●	●	
M 9	1,25	25 x 9	4	8,86	0090	●	○	●	○	○	
M 10	1,5	30 x 11	4	9,85	0100	●	●	●	●	●	
M 11	1,5	30 x 11	4	10,85	0110	●	○	●	○	○	
M 12	1,75	38 x 14	4	11,83	0120	●	●	●	○	●	
M 14	2	38 x 14	4	13,82	0140	●	●	●	○	●	
M 16	2	45 x 18	5	15,82	0160	●	●	●	○	●	
M 18	2,5	45 x 18	5	17,79	0180	●	●	●	○	●	
M 20	2,5	45 x 18	5	19,79	0200	●	●	●	○	●	
M 22	2,5	55 x 22	5	21,79	0220	●	●	●	○	●	
M 24	3	55 x 22	5	23,76	0240	●	●	●	○	●	
M 27	3	65 x 25	5	26,76	0270	●	●	●	○	●	
M 30	3,5	65 x 25	6	29,73	0300	●	●	●	○	●	
M 33	3,5	65 x 25	6	32,73	0330	●	●	●	○	○	
M 36	4	65 x 25	7	35,70	0360	●	●	●	○	○	
M 39	4	75 x 30	7	38,70	0390	●	○	○	○	○	
M 42	4,5	75 x 30	7	41,68	0420	●	○	○	○	○	
M 45	4,5	90 x 36	7	44,68	0450	●	○	○	○	○	
M 48	5	90 x 36	7	47,66	0480	●	○	○	○	○	
M 52	5	90 x 36	8	51,66	0520	●	○	○	○	○	
M 56	5,5	105 x 36	7	55,65	0560	○	○	○	○	○	
M 60	5,5	105 x 36	8	59,65	0600	○	○	○	○	○	
M 64	6	120 x 36	7	63,62	0640	○	○	○	○	○	
M 68	6	120 x 36	8	67,62	0680	○	○	○	○	○	



Мелкая метрическая резьба стандарта ISO DIN-13

800 800 800 SPN Ms INOX

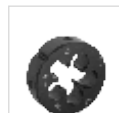
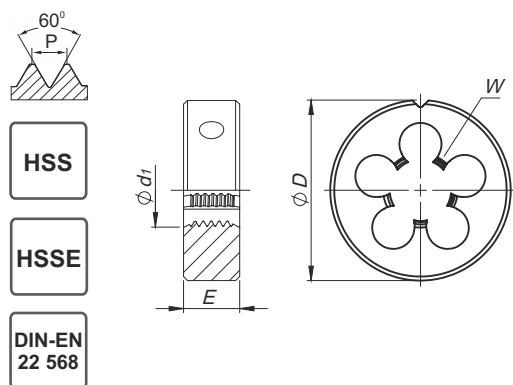

*SPN - Подточка передней поверхности

Материал	<table border="1"><tr><td>P</td><td>M</td><td>K</td></tr><tr><td>N</td><td>S</td><td>H</td></tr></table>	P	M	K	N	S	H	<table border="1"><tr><td>P</td><td>M</td><td>K</td></tr><tr><td>N</td><td>S</td><td>H</td></tr></table>	P	M	K	N	S	H	<table border="1"><tr><td>P</td><td>M</td><td>K</td></tr><tr><td>N</td><td>S</td><td>H</td></tr></table>	P	M	K	N	S	H	<table border="1"><tr><td>P</td><td>M</td><td>K</td></tr><tr><td>N</td><td>S</td><td>H</td></tr></table>	P	M	K	N	S	H	<table border="1"><tr><td>P</td><td>M</td><td>K</td></tr><tr><td>N</td><td>S</td><td>H</td></tr></table>	P	M	K	N	S	H
P	M	K																																	
N	S	H																																	
P	M	K																																	
N	S	H																																	
P	M	K																																	
N	S	H																																	
P	M	K																																	
N	S	H																																	
P	M	K																																	
N	S	H																																	
Исполнение		LH	SPN		SPN																														
Изготовлена из	HSS	HSS	HSS	HSS	HSSE																														
Сбег резьбы	1,75P	1,75P	1,75P	1,25P	2,25P																														

5

M d ₁	P	DxE	W		норма	DIN-EN 22 568					
						Точность	6g	6g	6g	6g	6g
						INDEX	N1-121001	N1-111001	N1-141001	N1-164001	N2-188001
M 3,5 x 0,5	0,5	20 x 5	3	3,43	0037	○	○	○	○	○	
M 4 x 0,5	0,5	20 x 5	4	3,92	0041	●	○	●	●	●	
M 4,5 x 0,5	0,5	20 x 5	4	4,43	0046	○	○	○	○	○	
M 5 x 0,5	0,5	20 x 5	4	4,92	0051	●	○	●	●	●	
M 5 x 0,75	0,75	20 x 5	4	4,91	0052	○	○	○	○	○	
M 5,5 x 0,5	0,5	20 x 5	4	5,43	0056	○	○	○	○	○	
M 5,5 x 0,75	0,75	20 x 7	4	5,42	0057	○	○	○	○	○	
M 6 x 0,5	0,5	20 x 7	4	5,92	0061	●	○	●	○	●	
M 6 x 0,75	0,75	20 x 7	4	5,90	0062	●	○	●	●	●	
M 7 x 0,75	0,75	25 x 9	4	6,90	0072	●	○	●	●	●	
M 8 x 0,5	0,5	25 x 9	4	7,92	0081	●	○	●	●	●	
M 8 x 0,75	0,75	25 x 9	4	7,90	0082	●	●	●	●	●	
M 8 x 1	1	25 x 9	4	7,88	0083	●	●	●	●	●	
M 9 x 0,75	0,75	25 x 9	4	8,90	0092	●	●	●	●	●	
M 9 x 1	1	25 x 9	4	8,88	0093	●	●	●	●	●	
M 10 x 0,75	0,75	30 x 11	4	9,90	0102	●	●	●	●	●	
M 10 x 1	1	30 x 11	5	9,88	0103	●	●	●	●	●	
M 10 x 1,25	1,25	30 x 11	4	9,86	0104	●	●	●	●	●	
M 11 x 0,75	0,75	30 x 11	5	10,91	0112	●	○	●	●	●	
M 11 x 1	1	30 x 11	4	10,88	0113	●	○	●	●	●	
M 12 x 1	1	38 x 10	4	11,88	0123	●	●	●	●	●	
M 12 x 1,25	1,25	38 x 10	4	11,86	0124	●	●	●	●	●	
M 12 x 1,5	1,5	38 x 10	4	11,85	0125	●	●	●	●	●	
M 14 x 1	1	38 x 10	5	13,88	0143	●	●	○	●	●	
M 14 x 1,5	1,5	38 x 10	5	13,85	0145	●	●	●	●	●	
M 15 x 1	1	38 x 10	5	14,88	0153	●	○	○	●	●	
M 15 x 1,5	1,5	38 x 10	5	14,85	0155	●	○	○	●	●	
M 16 x 1	1	45 x 14	5	15,88	0163	●	●	○	●	●	
M 16 x 1,5	1,5	45 x 14	5	15,85	0165	●	●	●	●	●	
M 17 x 1	1	45 x 14	5	16,88	0173	●	○	○	●	●	
M 17 x 1,5	1,5	45 x 14	5	16,85	0175	●	○	○	●	●	
M 18 x 1	1	45 x 14	5	17,88	0183	●	●	○	●	●	
M 18 x 1,5	1,5	45 x 14	5	17,85	0185	●	●	●	●	●	
M 18 x 2	2	45 x 14	5	17,82	0186	●	●	●	●	●	
M 20 x 1	1	45 x 14	6	19,80	0203	●	●	●	●	●	
M 20 x 1,5	1,5	45 x 14	6	19,85	0205	●	●	●	●	●	
M 20 x 2	2	45 x 14	6	19,82	0206	●	●	○	●	●	
M 22 x 1	1	55 x 16	6	21,88	0223	●	●	○	●	●	
M 22 x 1,5	1,5	55 x 16	6	21,85	0225	●	●	●	●	●	
M 22 x 2	2	55 x 16	6	21,82	0226	●	●	○	●	●	
M 24 x 1	1	55 x 16	6	23,88	0243	●	●	○	●	●	
M 24 x 1,5	1,5	55 x 16	6	23,85	0245	●	●	●	●	●	

Пример заказа
N1-121001-0041
DIN-EN 22 568 M4x0,5-6g HSS 800

● Доступно со склада
○ По запросу

Мелкая метрическая резьба стандарта ISO DIN-13						800	800	800 SPN	Ms	INOX	
*SPN - Подточка передней поверхности											
Материал											
Исполнение							LH	SPN		SPN	
Изготовлена из						HSS	HSS	HSS	HSS	HSSE	
Сбег резьбы						1,75P	1,75P	1,75P	1,25P	2,25P	
M d ₁	P	DxE	W		норма	DIN-EN 22 568					
						Точность	6g	6g	6g	6g	6g
						INDEX	N1-121001	N1-111001	N1-141001	N1-164001	N2-188001
M 24 x 2	2	55 x 16	6	23,82	0246	●	●	○	○	○	
M 25 x 1	1	55 x 16	6	24,88	0253	●	○	○	○	○	
M 25 x 1,5	1,5	55 x 16	6	24,85	0255	●	○	○	○	○	
M 25 x 2	2	55 x 16	6	24,82	0256	●	○	○	○	○	
M 26 x 1,5	1,5	55 x 16	6	25,85	0265	●	○	○	○	○	
M 27 x 1	1	65 x 18	6	26,88	0273	●	○	○	○	○	
M 27 x 1,5	1,5	65 x 18	6	26,85	0275	●	○	○	○	○	
M 27 x 2	2	65 x 18	6	26,82	0276	●	○	○	○	○	
M 28 x 1	1	65 x 18	6	27,88	0283	●	○	○	○	○	
M 28 x 1,5	1,5	65 x 18	6	27,85	0285	●	○	○	○	○	
M 28 x 2	2	65 x 18	6	27,82	0286	●	○	○	○	○	
M 30 x 1	1	65 x 18	6	29,88	0303	●	○	○	○	○	
M 30 x 1,5	1,5	65 x 18	6	29,85	0305	●	○	○	○	○	
M 30 x 2	2	65 x 18	6	29,82	0306	●	○	○	○	○	
M 30 x 3	3	65 x 25	6	29,76	0307	●	○	○	○	○	
M 32 x 1,5	1,5	65 x 18	7	31,85	0325	●	○	○	○	○	
M 32 x 2	2	65 x 18	7	31,82	0326	●	○	○	○	○	
M 33 x 1,5	1,5	65 x 18	7	32,85	0335	●	○	○	○	○	
M 33 x 2	2	65 x 18	7	32,82	0336	●	○	○	○	○	
M 33 x 3	3	65 x 25	7	32,76	0337	●	○	○	○	○	
M 35 x 1,5	1,5	65 x 18	7	34,85	0355	●	○	○	○	○	
M 36 x 1,5	1,5	65 x 18	7	35,85	0365	●	○	○	○	○	
M 36 x 2	2	65 x 18	7	35,82	0366	●	○	○	○	○	
M 36 x 3	3	65 x 25	7	35,76	0367	●	○	○	○	○	
M 38 x 1,5	1,5	75 x 20	7	37,85	0385	●	○	○	○	○	
M 39 x 1,5	1,5	75 x 20	7	38,85	0395	●	○	○	○	○	
M 39 x 2	2	75 x 20	7	38,82	0396	●	○	○	○	○	
M 39 x 3	3	75 x 30	7	38,76	0397	●	○	○	○	○	
M 40 x 1,5	1,5	75 x 20	7	39,85	0405	●	○	○	○	○	
M 40 x 2	2	75 x 20	7	39,82	0406	●	○	○	○	○	
M 40 x 3	3	75 x 30	7	39,76	0407	●	○	○	○	○	
M 42 x 1,5	1,5	75 x 20	7	41,85	0425	●	○	○	○	○	
M 42 x 2	2	75 x 20	8	41,82	0426	●	○	○	○	○	
M 42 x 3	3	75 x 30	7	41,76	0427	●	○	○	○	○	
M 45 x 1,5	1,5	90 x 22	7	44,85	0455	●	○	○	○	○	
M 45 x 2	2	90 x 22	7	44,82	0456	●	○	○	○	○	
M 45 x 3	3	90 x 36	7	44,76	0457	●	○	○	○	○	
M 48 x 1,5	1,5	90 x 22	7	47,85	0485	●	○	○	○	○	
M 48 x 2	2	90 x 22	7	47,82	0486	●	○	○	○	○	
M 48 x 3	3	90 x 36	7	47,76	0487	●	○	○	○	○	
M 48 x 4	4	90 x 36	7	47,73	0488	●	○	○	○	○	
M 50 x 1,5	1,5	90 x 22	8	49,85	0505	●	○	○	○	○	



Пример заказа

 N1-121001-0285
 DIN-EN 22 568 M28x1,5-6g HSS 800

 ● Доступно со склада
 ○ По запросу

Мелкая метрическая резьба стандарта ISO DIN-13						800	800	800 SPN	Ms	INOX	
*SPN - Подточка передней поверхности											
Материал											
Исполнение							LH	SPN		SPN	
Изготовлена из						HSS	HSS	HSS	HSS	HSSE	
Сбег резьбы						1,75P	1,75P	1,75P	1,25P	2,25P	
M d ₁	P	DxE	W		норма	DIN-EN 22 568					
						Точность	6g	6g	6g	6g	6g
						INDEX	N1-121001	N1-111001	N1-141001	N1-164001	N2-188001
M 50 x 2	2	90 x 22	8	49,82	0506	●	○	○	○	○	
M 50 x 3	3	90 x 36	8	49,76	0507	●	○	○	○	○	
M 52 x 1,5	1,5	90 x 22	8	51,85	0525	●	○	○	○	○	
M 52 x 2	2	90 x 22	8	51,82	0526	●	○	○	○	○	
M 52 X 3	3	90 x 36	8	51,76	0527	●	○	○	○	○	
M 52 x 4	4	90 x 36	8	51,73	0528	●	○	○	○	○	
M 55 x 1,5	1,5	105 x 22	8	54,85	0555	○	○	○	○	○	
M 55 x 2	2	105 x 22	7	54,82	0556	○	○	○	○	○	
M 55 x 3	3	105 x 36	7	54,76	0557	○	○	○	○	○	
M 55 x 4	4	105 x 36	7	54,73	0558	○	○	○	○	○	
M 56 x 1,5	2	105 x 22	8	55,85	0565	○	○	○	○	○	
M 56 x 2	2	105 x 22	8	55,82	0566	○	○	○	○	○	
M 56 x 3	3	105 x 36	8	55,76	0567	○	○	○	○	○	
M 56 x 4	4	105 x 36	7	55,73	0568	○	○	○	○	○	

**Американская унифицированная резьба
UNC, ANSI B-1.1**

800

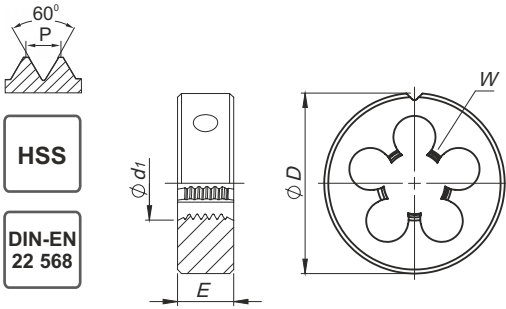

Материал



Исполнение

Изготовлена из

HSS

Сбег резьбы

1,75P

UNC	d ₁	1"/P	P	D x E	W		норма	Точность	INDEX
							DIN-EN 22 568		
								2A	
								N1-121001	
No 5 - 40	3,175	40	0,635	20 x 5	3	3,09	4105	●	
No 6 - 32	3,505	32	0,794	20 x 5	3	3,41	4106	●	
No 8 - 32	4,166	32	0,794	20 x 7	3	4,07	4108	●	
No 10 - 24	4,826	24	1,058	20 x 7	3	4,71	4110	●	
No 12 - 24	5,486	24	1,058	20 x 7	4	5,37	4112	●	
1/4 - 20	6,35	20	1,270	20 x 7	4	6,22	4127	●	
5/16 - 18	7,938	18	1,411	25 x 9	4	7,80	4128	●	
3/8 - 16	9,525	16	1,588	30 x 11	4	9,37	4129	●	
7/16 - 14	11,112	14	1,814	30 x 11	4	10,95	4130	●	
1/2 - 13	12,7	13	1,954	38 x 14	4	12,52	4131	●	
9/16 - 12	14,288	12	2,117	38 x 14	4	14,10	4132	●	
5/8 - 11	15,875	11	2,309	45 x 18	5	15,68	4133	●	
3/4 - 10	19,05	10	2,504	45 x 18	5	18,84	4135	●	
7/8 - 9	22,225	9	2,822	55 x 22	5	22,00	4137	●	
1 - 8	25,4	8	3,175	55 x 22	5	25,16	4139	●	
1.1/8 - 7	28,575	7	3,629	65 x 25	5	28,31	4141	○	
1.1/4 - 7	31,75	7	3,629	65 x 25	6	31,49	4143	○	
1.3/8 - 6	34,925	6	4,233	65 x 25	7	34,63	4145	○	
1.1/2 - 6	38,1	6	4,233	75 x 30	6	37,80	4147	○	
1.3/4 - 5	44,45	5	5,080	90 x 36	6	44,12	4151	○	
2 - 4.1/2	50,8	4.1/2	5,645	90 x 36	7	50,45	4155	○	

5

Пример заказа

 N1-121001-4128
DIN-EN 22 568 5/16-18 UNC-2A HSS 800

 ● Доступно со склада
○ По запросу

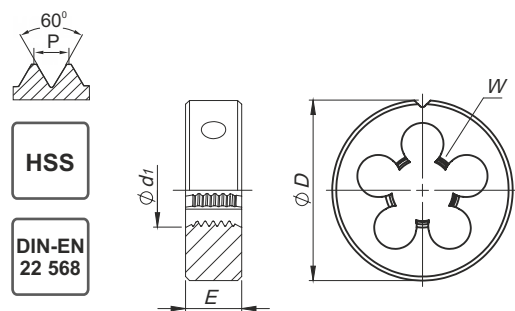
Американская унифицированная резьба с мелким шагом UNF, ANSI B-1.1

800



Материал



Исполнение

Изготовлена из

HSS

Сбег резьбы

1,75P

UNF	d,	1"/P	P	D x E	W		норма	Точность	INDEX
							DIN-EN 22 568		
								2A	
								N1-121001	
No 5 - 44	3,175	44	0,577	20 x 5	3	3,10	4205	●	
No 6 - 40	3,505	40	0,635	20 x 5	3	3,42	4206	●	
No 8 - 36	4,166	36	0,705	20 x 7	3	4,08	4208	●	
No 10 - 32	4,826	32	0,794	20 x 7	3	4,73	4210	●	
No 12 - 28	5,486	28	0,907	20 x 7	4	5,38	4212	●	
1/4 - 28	6,35	28	0,907	20 x 7	4	6,24	4227	●	
5/16 - 24	7,938	24	1,058	25 x 9	5	7,82	4228	●	
3/8 - 24	9,525	24	1,058	30 x 11	4	9,41	4229	●	
7/16 - 20	11,112	20	1,270	30 x 11	5	10,98	4230	●	
1/2 - 20	12,7	20	1,270	38 x 10	5	12,56	4231	●	
9/16 - 18	14,288	18	1,411	38 x 10	5	14,14	4232	●	
5/8 - 18	15,875	18	1,411	45 x 14	5	15,73	4233	●	
3/4 - 16	19,05	16	1,588	45 x 14	6	18,89	4235	●	
7/8 - 14	22,225	14	1,814	55 x 16	5	22,05	4237	●	
1 - 12	25,4	12	2,117	55 x 16	6	25,21	4239	●	
1.1/8 - 12	28,575	12	2,117	65 x 18	6	28,38	4241	○	
1.1/4 - 12	31,75	12	2,117	65 x 18	6	31,55	4243	○	
1.3/8 - 12	34,925	12	2,117	65 x 18	7	34,73	4245	○	
1.1/2 - 12	38,1	12	2,117	75 x 20	8	37,90	4247	○	

5

Пример заказа

 N1-121001-4228
 DIN-EN 22 568 5/16-24 UNF-2A HSS 800

● Доступно со склада

○ По запросу

Трубная резьба Витворта G, DIN-ISO 228							800	800	Ms	INOX		
HSS HSSE DIN-EN 24 231							P M K N S H					
Материал							P M K N S H		P M K N S H		P M K N S H	
Исполнение							LH				SPN	
Изготовлена из							HSS		HSS		HSSE	
Сбег резьбы							1,75P		1,75P		1,25P	
							DIN-EN 24231					
G	d ₁	1"/P	P	D x E	W		норма					
							Точность					
							INDEX	N1-121001	N1-111001	N1-164001	N2-188001	
G1/8	9,73	28	0,907	30 x 11	4	9,62	3123	●	○	●	●	
G1/4	13,16	19	1,337	38 x 10	4	13,03	3127	●	○	●	●	
G3/8	16,66	19	1,337	45 x 14	5	16,54	3129	●	●	●	●	
G1/2	20,96	14	1,814	45 x 14	6	20,81	3131	●	●	●	●	
G5/8	22,91	14	1,814	55 x 16	5	22,77	3133	●	○	○	○	
G3/4	26,44	14	1,814	55 x 16	6	26,30	3135	●	●	●	●	
G7/8	30,20	14	1,814	65 x 18	6	30,06	3137	●	○	○	○	
G1	33,25	11	2,309	65 x 18	7	33,07	3139	●	●	●	●	
G1.1/8	37,90	11	2,309	75 x 20	7	37,72	3141	○	○	○	○	
G1.1/4	41,91	11	2,309	75 x 20	8	41,73	3143	●	○	○	○	
G1.3/8	44,32	11	2,309	90 x 22	7	44,14	3145	○	○	○	○	
G1.1/2	47,80	11	2,309	90 x 22	7	47,62	3147	●	○	○	○	
G1.3/4	53,75	11	2,309	105 x 22	8	53,57	3151	○	○	○	○	
G2	59,61	11	2,309	105 x 22	8	59,43	3155	○	○	○	○	
G2.1/4	65,71	11	2,309	120 x 22	8	65,49	3157	○	○	○	○	



Наружная трубная коническая резьба R, ISO-7/1

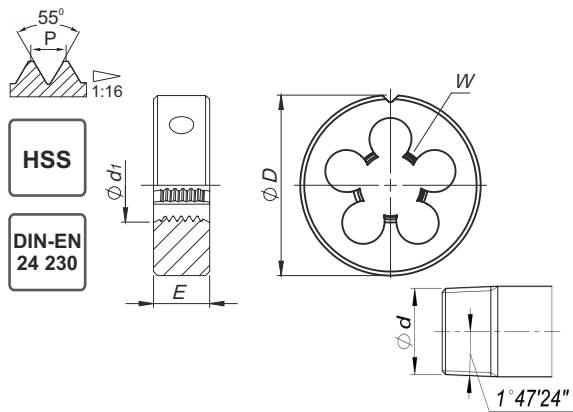

800



Материал



Исполнение

Изготовлена из

HSS

Сбег резьбы

2P

G	d ₁	1"/P	P	D x E	W		норма
							Точность
							DIN-EN 24 230
							INDEX
							N1-121001
R-1/8"	9,73	28	0,907	30 x 11	5	9,48	3423
R-1/4"	13,16	19	1,337	38 x 14	5	12,78	3427
R-3/8"	16,16	19	1,337	45 x 18	5	16,26	3429
R-1/2"	20,96	14	1,814	55 x 22	5	20,44	3431
R-3/4"	26,44	14	1,814	55 x 22	6	25,85	3435
R-1"	32,25	11	2,309	65 x 25	7	32,60	3439

5

Резьба витворта (крупный шаг) bsw, bs-84:1956								800			
HSS DIN-EN 22 568											
Материал								P M K N S H			
Исполнение											
Изготовлена из								HSS			
Сбег резьбы								1,75P			
BSW	d ₁	1"/P	P	D x E	W		норма				
							Точность				
							DIN-EN 22 568				
							medium				
							INDEX	N1-121001			
1/8 - 40	3,18	40	0,635	20 x 5	3	3,09	7123	●			
3/16 - 24	4,76	24	1,058	20 x 7	4	4,66	7125	●			
1/4 - 20	6,35	20	1,270	20 x 7	4	6,24	7127	●			
5/16 - 18	7,94	18	1,411	25 x 9	4	7,82	7128	●			
3/8 - 16	9,53	16	1,588	30 x 11	4	9,40	7129	●			
7/16 - 14	11,11	14	1,814	30 x 11	4	10,98	7130	●			
1/2 - 12	12,7	12	2,117	38 x 14	4	12,56	7131	●			
9/16 - 12	14,29	12	2,117	38 x 14	4	14,14	7132	●			
5/8 - 11	15,88	11	2,309	45 x 18	5	15,72	7133	●			
3/4 - 10	19,05	10	2,504	45 x 18	5	18,89	7135	●			
7/8 - 9	22,23	9	2,822	55 x 22	5	22,10	7137	●			
1 - 8	25,4	8	3,175	55 x 22	5	25,27	7139	●			



**Резьба Витворта (МЕЛКИЙ ШАГ)
BSF, BS-84:1956**

800

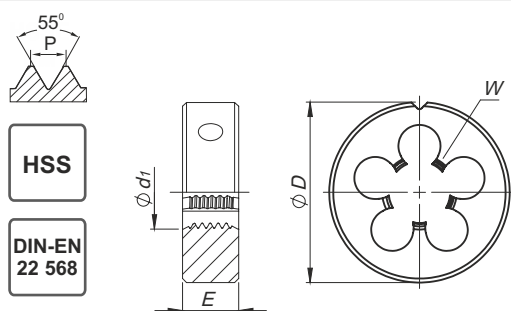

Материал



Исполнение

Изготовлена из

HSS

Сбег резьбы

1,75P

BSF	d ₁	1"/P	P	D x E	W		норма	
							DIN-EN 22 568	
							Точность	
							medium	
							INDEX	
							N1-121001	
3/16 - 32	4,76	32	0,794	20 x 7	4	4,76	7225	●
1/4 - 26	6,35	26	0,977	20 x 7	4	6,25	7227	●
5/16 - 22	7,94	22	1,155	25 x 9	4	7,83	7228	●
3/8 - 20	9,53	20	1,270	30 x 11	4	9,41	7229	●
7/16 - 18	11,11	18	1,411	30 x 11	5	10,99	7230	●
1/2 - 16	12,70	16	1,588	38 x 10	5	12,57	7231	●
9/16 - 16	14,29	16	1,588	38 x 10	4	14,16	7232	●
5/8 - 14	15,88	14	1,814	45 x 14	4	15,73	7233	●
3/4 - 12	19,05	12	2,117	45 x 14	5	18,89	7235	●
7/8 - 11	22,23	11	2,309	55 x 22	5	22,11	7237	●
1 - 10	25,40	10	2,504	55 x 22	5	25,28	7239	●

5

Пример заказа

N1-121001-7232
DIN-EN 22 568 9/16 - 16 BSF HSS 800

● Доступно со склада

○ По запросу

Американская коническая трубная резьба NPT 1:16, ANSI B-1.20.1								800			
Материал											
Исполнение											
Изготовлена из								HSS			
Сбег резьбы								2P			
норма								DIN-EN 24 230			
NPT	d ₁	1"/P	P	D x E	W		Точность				
							INDEX	N1-121001			
1/8	9,728	27	0,941	30 x 11	5	9,99	4623	●			
1/4	13,157	18	1,411	38 x 14	5	13,26	4627	●			
3/8	16,662	18	1,411	45 x 18	5	16,67	4629	●			
1/2	20,955	14	1,814	45 x 18	6	20,71	4631	●			
3/4	26,441	14	1,814	55 x 22	6	26,03	4635	●			
1	33,249	11.1/2	2,209	65 x 25	7	32,59	4639	●			



инструмент для сверления



ТАБЛИЦА ПОДБОРА ИНСТРУМЕНТА

7-8

СТРАНИЦЫ КАТАЛОГА

129-157

VHM	Твердосплавные спиральные сверла Максимальная глубина отверстия	3xD	DIN-6537	MASTERDRILL	IBOO	129-131
VHM	Твердосплавные спиральные сверла Максимальная глубина отверстия	5xD	DIN-6537	MASTERDRILL	IBOO	132-134
VHM	Твердосплавные спиральные сверла Максимальная глубина отверстия	8xD	DIN-6537		IBOO	135-137
VHM	Сверла твердосплавные спиральные		DIN-6539		IBOOmicro	138
VHM	Твердосплавные ступенчатые сверла для отверстий под метчики		DIN-6537		IBOO	139
VHM	Сверла твердосплавные ступенчатые для раскатников		~DIN-6537		IBOO	140
VHM	Сверла твердосплавные ступенчатые для винтов		~DIN-6537		IBOO	141
VHM	Сверла твердосплавные спиральные для алюминия Максимальная глубина отверстия	5xD	DIN-6537		AL	142-144
HSSE	Спиральные сверла		DIN-338		INOX	145-147
HSS	Многоступенчатые сверла					148
VHM	Сверла для извлечения сломанных метчиков					149
HSSE VHM	Центровочные сверла типа пс					150
HSS	Центровочные сверла типа		DIN-333A			151
VHM	Инструмент для снятия фасок и заусенцев		DIN-6537L			152
HSS	Зенковки		DIN-335			153-154
HM	Зенковки		DIN-373			155
HSS	Зенкеры с жесткой направляющей		DIN-373			156
HSS	Конические развертки 1:16		DIN-335			157

3xD Максимальная глубина отверстия

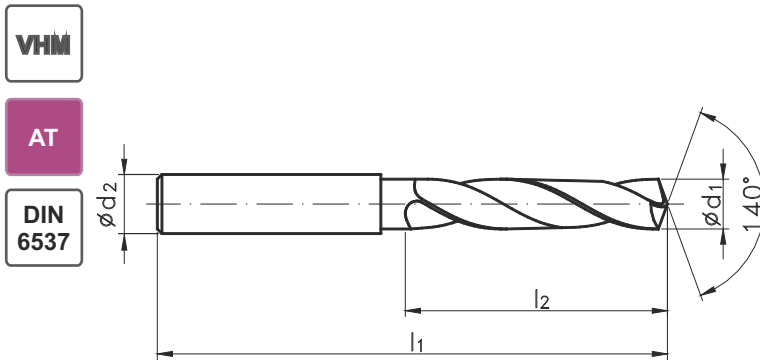
MASTERDRILL
1300

VHM
AT
DIN 6537

Обрабатываемые материалы



внутреннее охлаждение

IK

-

IK

Изготовлено из

VHM

VHM

VHM

Покрытие

AT

AT

AT

d ₁	M MF	M "WGN"	l ₁	l ₂	d ₂ h ₆	Норма	DIN-6537		
						Точность	m7	m7	m7
						INDEX	W9-604M33	W9-604013	W9-604033
3,00			62	20	6,0	0300	●	●	○
3,10			62	20	6,0	0310	○	○	○
3,20			62	20	6,0	0320	●	●	○
3,25		M3,5	62	20	6,0	0325	○	○	○
3,30	M4		62	20	6,0	0330	●	●	○
3,40			62	20	6,0	0340	○	○	○
3,50	M4x0,5		62	20	6,0	0350	○	●	○
3,60			62	20	6,0	0360	○	○	○
3,70	M4,5	M4	62	20	6,0	0370	●	●	○
3,80			66	24	6,0	0380	●	●	○
3,90			66	24	6,0	0390	○	○	○
4,00			66	24	6,0	0400	●	●	●
4,10			66	24	6,0	0410	○	○	○
4,20	M5	M4,5	66	24	6,0	0420	●	●	○
4,30			66	24	6,0	0430	●	●	○
4,40			66	24	6,0	0440	○	●	○
4,50	M5x0,5		66	24	6,0	0450	●	●	○
4,60	M5,5		66	24	6,0	0460	○	○	○
4,65		M5	66	24	6,0	0465	○	○	○
4,70			66	24	6,0	0470	○	○	○
4,80			66	28	6,0	0480	○	○	○
4,90			66	28	6,0	0490	○	○	○
5,00	M6		66	28	6,0	0500	●	●	●
5,10		M5,5	66	28	6,0	0510	○	●	○
5,20	M6x0,75		66	28	6,0	0520	●	●	○
5,30			66	28	6,0	0530	○	○	○
5,40			66	28	6,0	0540	○	○	○
5,50			66	28	6,0	0550	●	●	○
5,60		M6	66	28	6,0	0560	○	○	○
5,70			66	28	6,0	0570	○	○	○
5,80			66	28	6,0	0580	○	○	○
5,90			66	28	6,0	0590	○	○	○
6,00	M7		66	28	6,0	0600	●	●	●
6,10			79	34	8,0	0610	○	○	○
6,20	M7x0,75		79	34	8,0	0620	○	○	○
6,30			79	34	8,0	0630	○	○	○
6,40			79	34	8,0	0640	○	○	○
6,50			79	34	8,0	0650	●	●	○
6,60		M7	79	34	8,0	0660	○	○	○
6,70			79	34	8,0	0670	○	○	○
6,80	M8		79	34	8,0	0680	●	●	●
6,90			79	34	8,0	0690	○	○	○
7,00	M8x1		79	34	8,0	0700	●	●	○
7,10			79	41	8,0	0710	○	○	○
7,20	M8x0,75		79	41	8,0	0720	○	○	○
7,30			79	41	8,0	0730	○	○	○

6



3xD Максимальная глубина отверстия

MASTERDRILL

I300

VHM

AT

DIN 6537

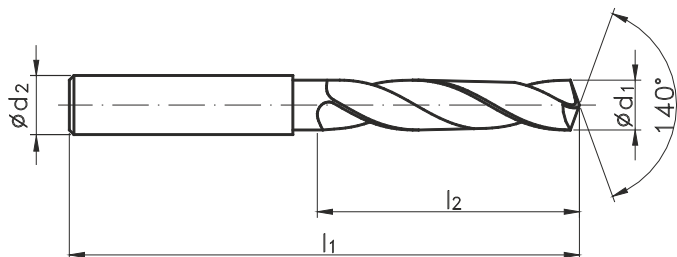

Обрабатываемые материалы



внутреннее охлаждение

IK

-

IK

Изготовлено из

VHM

VHM

VHM

Покрытие

AT

AT

AT

d ₁	M MF	M "WGN"	l ₁	l ₂	d ₂ h6	Норма	DIN-6537			
							Точность	m7	m7	m7
								INDEX	W9-604M33	W9-604013
7,40			79	41	8,0	0740	○	○	○	
7,45		M8	79	41	8,0	0745	●	○	○	
7,50			79	41	8,0	0750	○	●	●	
7,60		M8x1	79	41	8,0	0760	●	○	○	
7,70			79	41	8,0	0770	○	○	○	
7,80	M9		79	41	8,0	0780	●	○	○	
7,90			79	41	8,0	0790	○	○	○	
8,00	M9x1		79	41	8,0	0800	●	●	●	
8,10			89	47	10,0	0810	○	○	○	
8,20	M9x0,75		89	47	10,0	0820	○	○	○	
8,30			89	47	10,0	0830	○	○	○	
8,40			89	47	10,0	0840	○	○	○	
8,45		M9	89	47	10,0	0845	○	○	○	
8,50	M10		89	47	10,0	0850	●	●	●	
8,60		M9x1	89	47	10,0	0860	○	○	○	
8,70		M9x0,75	89	47	10,0	0870	○	○	○	
8,80	M10x1,25		89	47	10,0	0880	○	○	○	
8,90			89	47	10,0	0890	○	○	○	
9,00	M10x1		89	47	10,0	0900	●	●	●	
9,10			89	47	10,0	0910	○	○	○	
9,20	M10x0,75		89	47	10,0	0920	○	○	○	
9,30			89	47	10,0	0930	○	○	○	
9,35		M10	89	47	10,0	0935	●	●	○	
9,40			89	47	10,0	0940	○	○	○	
9,45		M10x1,25	89	47	10,0	0945	○	○	○	
9,50	M11		89	47	10,0	0950	●	●	●	
9,60		M10x1	89	47	10,0	0960	○	○	○	
9,70		M10x0,75	89	47	10,0	0970	○	○	○	
9,80			89	47	10,0	0980	●	●	○	
9,90			89	47	10,0	0990	○	○	○	
10,00	M11x1		89	47	10,0	1000	●	●	●	
10,10			102	55	12,0	1010	○	○	○	
10,20	M12		102	55	12,0	1020	●	●	○	
10,30			102	55	12,0	1030	○	○	○	
10,40			102	55	12,0	1040	○	○	○	
10,50	M12x1,5		102	55	12,0	1050	●	●	○	
10,60		M11x1	102	55	12,0	1060	○	○	○	
10,70			102	55	12,0	1070	○	○	○	
10,80	M12x1,25		102	55	12,0	1080	○	○	○	
10,90			102	55	12,0	1090	○	○	○	
11,00	M12x1		102	55	12,0	1100	●	●	○	
11,10			102	55	12,0	1110	○	○	○	
11,20			102	55	12,0	1120	○	○	○	
11,25		M12	102	55	12,0	1125	○	○	○	
11,30			102	55	12,0	1130	○	○	○	
11,35		M12x1,5	102	55	12,0	1135	○	○	○	

6

3xD Максимальная глубина отверстия						MASTERDRILL	I300		
VHM AT DIN 6537									
Обрабатываемые материалы									
внутреннее охлаждение						IK	-	IK	
Изготовлено из						VHM	VHM	VHM	
Покрытие						AT	AT	AT	
d ₁	M MF	M "WGN"	l ₁	l ₂	d ₂ h6	DIN-6537			
						Точность	m7	m7	m7
						INDEX	W9-604M33	W9-604013	W9-604033
11,40			102	55	12,0	1140	○	○	○
11,45		M12x1,25	102	55	12,0	1145	○	○	○
11,50			102	55	12,0	1150	●	●	○
11,60		M12x1	102	55	12,0	1160	○	○	○
11,70			102	55	12,0	1170	○	○	○
11,80			102	55	12,0	1180	●	●	○
11,90			102	55	12,0	1190	○	○	○
12,00	M14		102	55	12,0	1200	●	●	○
12,30			107	60	14,0	1230	○	○	○
12,50	M14x1,5		107	60	14,0	1250	●	●	○
12,80	M14x1,25		107	60	14,0	1280	○	○	○
13,00	M14x1	M14	107	60	14,0	1300	●	●	○
13,50			107	60	14,0	1350	●	●	○
13,80			107	60	14,0	1380	○	○	○
14,00	M16; M15x1		107	60	14,0	1400	●	●	○
14,50	M16x1,5		115	65	16,0	1450	●	●	○
14,80			115	65	16,0	1480	○	○	○
15,00	M16x1	M16	115	65	16,0	1500	●	●	○
15,35		M16x1,5	115	65	16,0	1535	○	○	○
15,50	M18		115	65	16,0	1550	○	○	○
15,80			115	65	16,0	1580	●	●	○
16,00	M18x2		115	65	16,0	1600	●	●	○
16,50	M18x1,5		123	73	18,0	1650	○	○	○
16,80		M18	123	73	18,0	1680	○	○	○
17,00	M18x1		123	73	18,0	1700	●	●	○
17,35		M18x1,5	123	73	18,0	1735	○	○	○
17,50	M20		123	73	18,0	1750	○	○	○
17,80			123	73	18,0	1780	○	○	○
18,00	M20x2		123	73	18,0	1800	●	●	○
18,50	M20x1,5		131	79	20,0	1850	○	○	○
18,80		M20	131	79	20,0	1880	○	○	○
19,00	M20x1		131	79	20,0	1900	○	○	○
19,35		M20x1,5	131	79	20,0	1935	○	○	○
19,50	M22		131	79	20,0	1950	○	○	○
19,80			131	79	20,0	1980	○	○	○
20,00	M22x2		131	79	20,0	2000	○	○	○

5xD Максимальная глубина отверстия

MASTERDRILL

I300

VHM

AT

DIN 6537

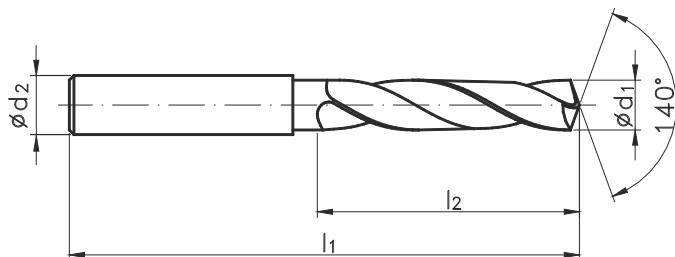

Обрабатываемые материалы



внутреннее охлаждение

IK

-

IK

Изготовлено из

VHM

VHM

VHM

Покрытие

AT

AT

AT

d ₁	M MF	M "WGN"	l ₁	l ₂	d ₂ h6	Индекс	DIN-6537		
							Точность		
							m7	m7	m7
						W9-614M33	W9-614013	W9-614033	
3,00			66	28	6,0	0300	●	●	○
3,10			66	28	6,0	0310	○	●	○
3,20			66	28	6,0	0320	●	●	○
3,25		M3,5	66	28	6,0	0325	○	●	○
3,30	M4		66	28	6,0	0330	●	●	○
3,40			66	28	6,0	0340	○	○	○
3,50	M4x0,5		66	28	6,0	0350	○	●	○
3,60			66	28	6,0	0360	○	●	○
3,70	M4,5	M4	66	28	6,0	0370	●	●	○
3,80			74	36	6,0	0380	●	●	○
3,90			74	36	6,0	0390	○	○	○
4,00			74	36	6,0	0400	●	●	●
4,10			74	36	6,0	0410	○	○	○
4,20	M5	M4,5	74	36	6,0	0420	●	●	●
4,30			74	36	6,0	0430	●	●	○
4,40			74	36	6,0	0440	○	○	○
4,50	M5x0,5		74	36	6,0	0450	●	●	○
4,60	M5,5		74	36	6,0	0460	○	○	○
4,65		M5	74	36	6,0	0465	○	○	○
4,70			74	36	6,0	0470	○	○	○
4,80			82	44	6,0	0480	○	○	○
4,90			82	44	6,0	0490	○	○	○
5,00	M6		82	44	6,0	0500	●	●	●
5,10		M5,5	82	44	6,0	0510	○	○	○
5,20	M6x0,75		82	44	6,0	0520	●	●	○
5,30			82	44	6,0	0530	○	○	○
5,40			82	44	6,0	0540	○	○	○
5,50			82	44	6,0	0550	●	●	●
5,60		M6	82	44	6,0	0560	●	●	○
5,70			82	44	6,0	0570	○	○	○
5,80			82	44	6,0	0580	○	○	○
5,90			82	44	6,0	0590	○	○	○
6,00	M7		82	44	6,0	0600	●	○	●
6,10			91	53	8,0	0610	○	○	○
6,20	M7x0,75		91	53	8,0	0620	○	○	○
6,30			91	53	8,0	0630	○	○	○
6,40			91	53	8,0	0640	○	○	○
6,50			91	53	8,0	0650	●	●	●
6,60		M7	91	53	8,0	0660	○	○	○
6,70			91	53	8,0	0670	○	○	○
6,80	M8		91	53	8,0	0680	●	●	●
6,90			91	53	8,0	0690	○	○	○
7,00	M8x1		91	53	8,0	0700	●	●	●
7,10			91	53	8,0	0710	○	○	○
7,20	M8x0,75		91	53	8,0	0720	○	○	○
7,30			91	53	8,0	0730	○	○	○

6

5xD Максимальная глубина отверстия

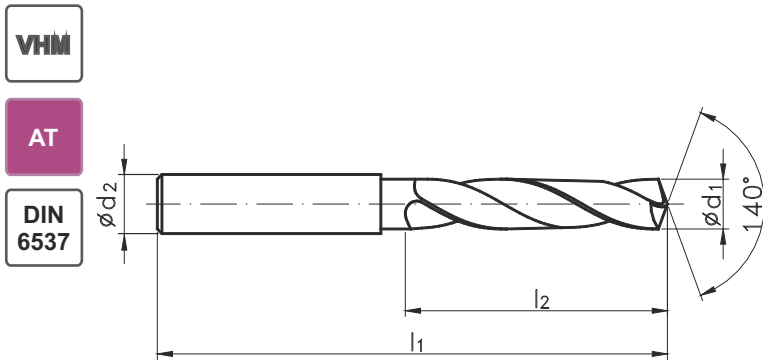
MASTERDRILL
1300

VHM
AT
DIN 6537



Обрабатываемые материалы



внутреннее охлаждение

IK - IK

Изготовлено из

VHM VHM VHM

Покрытие

AT AT AT

d ₁	M MF	M "WGN"	l ₁	l ₂	d ₂ h6	Норма	DIN-6537		
						Точность	m7	m7	m7
						INDEX	W9-614M33	W9-614013	W9-614033
7,40			91	53	8,0	0740	○	○	○
7,45		M8	91	53	8,0	0745	●	●	○
7,50			91	53	8,0	0750	○	●	●
7,60		M8x1	91	53	8,0	0760	●	●	○
7,70			91	53	8,0	0770	○	○	○
7,80	M9		91	53	8,0	0780	●	●	○
7,90			91	53	8,0	0790	○	○	○
8,00	M9x1		91	53	8,0	0800	●	●	●
8,10			103	61	10,0	0810	○	○	○
8,20	M9x0,75		103	61	10,0	0820	○	○	○
8,30			103	61	10,0	0830	○	○	○
8,40			103	61	10,0	0840	○	○	○
8,45		M9	103	61	10,0	0845	○	○	○
8,50	M10		103	61	10,0	0850	●	●	●
8,60		M9x1	103	61	10,0	0860	○	○	○
8,70		M9x0,75	103	61	10,0	0870	○	○	○
8,80	M10x1,25		103	61	10,0	0880	○	○	○
8,90			103	61	10,0	0890	○	○	○
9,00	M10x1		103	61	10,0	0900	●	●	●
9,10			103	61	10,0	0910	○	○	○
9,20	M10x0,75		103	61	10,0	0920	○	○	○
9,30			103	61	10,0	0930	○	○	○
9,35		M10	103	61	10,0	0935	●	●	○
9,40			103	61	10,0	0940	○	○	○
9,45		M10x1,25	103	61	10,0	0945	○	○	○
9,50	M11		103	61	10,0	0950	●	●	○
9,60		M10x1	103	61	10,0	0960	○	○	○
9,70		M10x0,75	103	61	10,0	0970	○	○	○
9,80			103	61	10,0	0980	●	●	○
9,90			103	61	10,0	0990	○	○	○
10,00	M11x1		103	61	10,0	1000	●	●	●
10,10			118	71	12,0	1010	○	○	○
10,20	M12		118	71	12,0	1020	●	●	○
10,30			118	71	12,0	1030	○	○	○
10,40			118	71	12,0	1040	○	○	○
10,50	M12x1,5		118	71	12,0	1050	●	●	○
10,60		M11x1	118	71	12,0	1060	○	○	○
10,70			118	71	12,0	1070	○	○	○
10,80	M12x1,25		118	71	12,0	1080	○	○	○
10,90			118	71	12,0	1090	○	○	○
11,00	M12x1		118	71	12,0	1100	●	●	●
11,10			118	71	12,0	1110	○	○	○
11,20			118	71	12,0	1120	○	○	○
11,25		M12	118	71	12,0	1125	○	○	○
11,30			118	71	12,0	1130	○	○	○
11,35		M12,1,5	118	71	12,0	1135	○	○	○

6

5xD Максимальная глубина отверстия

MASTERDRILL

I300

VHM

AT

DIN 6537

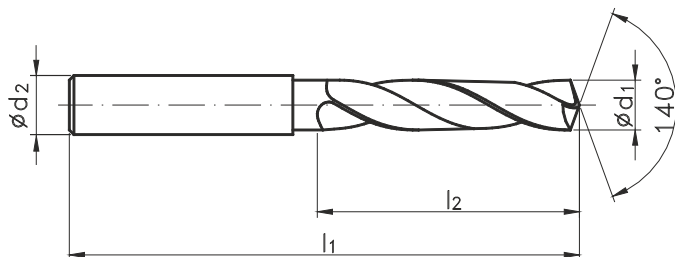

Обрабатываемые материалы



внутреннее охлаждение

IK

-

IK

Изготовлено из

VHM

VHM

VHM

Покрытие

AT

AT

AT

d ₁	M MF	M "WGN"	l ₁	l ₂	d ₂ h6	Норма	DIN-6537		
						Точность	m7	m7	m7
						INDEX	W9-614M33	W9-614013	W9-614033
11,40			118	71	12,0	1140	○	○	○
11,45		M12x1,25	118	71	12,0	1145	○	○	○
11,50			118	71	12,0	1150	●	●	○
11,60		M12x1	118	71	12,0	1160	○	○	○
11,70			118	71	12,0	1170	○	○	○
11,80			118	71	12,0	1180	●	●	○
11,90			118	71	12,0	1190	○	○	○
12,00	M14		118	71	12,0	1200	○	○	●
12,30			124	77	14,0	1230	○	○	○
12,50	M14x1,5		124	77	14,0	1250	●	●	○
12,80	M14x1,25		124	77	14,0	1280	○	○	○
13,00	M14x1	M14	124	77	14,0	1300	●	●	●
13,50			124	77	14,0	1350	●	●	○
13,80			124	77	14,0	1380	○	○	○
14,00	M16; M15x1		124	77	14,0	1400	●	●	●
14,50	M16x1,5		133	83	16,0	1450	●	●	○
14,80			133	83	16,0	1480	○	○	○
15,00	M16x1	M16	133	83	16,0	1500	●	●	○
15,35		M16x1,5	133	83	16,0	1535	○	○	○
15,50	M18		133	83	16,0	1550	○	○	○
15,80			133	83	16,0	1580	●	●	○
16,00	M18x2		133	83	16,0	1600	●	●	○
16,50	M18x1,5		143	93	18,0	1650	○	○	○
16,80		M18	143	93	18,0	1680	○	○	○
17,00	M18x1		143	93	18,0	1700	●	●	○
17,35		M18x1,5	143	93	18,0	1735	○	○	○
17,50	M20		143	93	18,0	1750	○	○	○
17,80			143	93	18,0	1780	○	○	○
18,00	M20x2		143	93	18,0	1800	●	●	○
18,50	M20x1,5		153	101	20,0	1850	○	○	○
18,80		M20	153	101	20,0	1880	○	○	○
19,00	M20x1		153	101	20,0	1900	○	○	○
19,35		M20x1,5	153	101	20,0	1935	○	○	○
19,50	M22		153	101	20,0	1950	○	○	○
19,80			153	101	20,0	1980	○	○	○
20,00	M22x2		153	101	20,0	2000	○	○	○

6

8xD Максимальная глубина отверстия 4 Ленточки **1300**

VHM

AT

DIN 6537

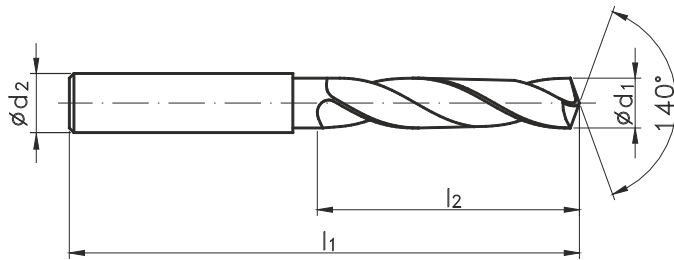

Обрабатываемые материалы



внутреннее охлаждение

IK

Изготовлено из

VHM

Покрытие

AT

d ₁	M MF	M "WGN"	l ₁	l ₂	d ₂ h6	Норма	DIN-6537			
						Точность	m7			
						INDEX	W9-624063			
3,00			72	34	6,0	0300	o			
3,10			72	34	6,0	0310	o			
3,20			72	34	6,0	0320	o			
3,30	M4		72	34	6,0	0330	o			
3,40			72	34	6,0	0340	o			
3,50	M4x0,5		72	34	6,0	0350	o			
3,60			72	34	6,0	0360	o			
3,70	M4,5	M4	72	34	6,0	0370	o			
3,80	M4x0,5		81	43	6,0	0380	o			
3,90			81	43	6,0	0390	o			
4,00			81	43	6,0	0400	o			
4,10			81	43	6,0	0410	o			
4,20	M5	M4,5	81	43	6,0	0420	o			
4,30			81	43	6,0	0430	o			
4,40			81	43	6,0	0440	o			
4,50	M5x0,5		81	43	6,0	0450	o			
4,60	M5,5		81	43	6,0	0460	o			
4,70			81	43	6,0	0470	o			
4,80	M5x0,5		95	57	6,0	0480	o			
4,90			95	57	6,0	0490	o			
5,00	M6		95	57	6,0	0500	o			
5,10		M5,5	95	57	6,0	0510	o			
5,20	M6x0,75		95	57	6,0	0520	o			
5,30			95	57	6,0	0530	o			
5,40			95	57	6,0	0540	o			
5,50			95	57	6,0	0550	o			
5,60		M6	95	57	6,0	0560	o			
5,70	M6x0,75		95	57	6,0	0570	o			
5,80	M6x0,5		95	57	6,0	0580	o			
5,90			95	57	6,0	0590	o			
6,00	M7		95	57	6,0	0600	o			
6,10			114	76	8,0	0610	o			
6,20	M7x0,75		114	76	8,0	0620	o			
6,30			114	76	8,0	0630	o			
6,40			114	76	8,0	0640	o			
6,50			114	76	8,0	0650	o			
6,60		M7	114	76	8,0	0660	o			
6,70	M7x0,75		114	76	8,0	0670	o			
6,80	M8		114	76	8,0	0680	o			
6,90			114	76	8,0	0690	o			
7,00	M8x1		114	76	8,0	0700	o			
7,10			114	76	8,0	0710	o			
7,20	M8x0,75		114	76	8,0	0720	o			
7,30			114	76	8,0	0730	o			
7,40			114	76	8,0	0740	o			
7,50			114	76	8,0	0750	o			

6



Пример заказа

 W9-624063-0300
 WK 1300 3,00 DIN-6537 VHM AT

- Доступно со склада
- По запросу

 Возможность выполнения сверл с
 хвостовиком по DIN-6535-HB, DIN-6535-HE

8xD Максимальная глубина отверстия **4** Ленточки **1300**

VHM

AT

DIN 6537

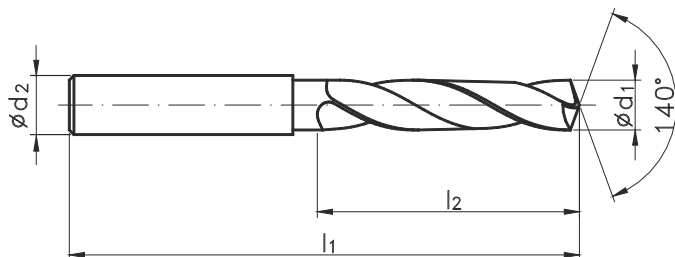

Обрабатываемые материалы



внутреннее охлаждение

IK

Изготовлено из

VHM

Покрытие

AT

d ₁	M MF	M "WGN"	l ₁	l ₂	d ₂ h6	Норма DIN-6537	
						Точность	m7
						INDEX	W9-624063
7,60	M8x1		114	76	8,0	0760	o
7,70	M8x0,75		114	76	8,0	0770	o
7,80	M9		114	76	8,0	0780	o
7,90			114	76	8,0	0790	o
8,00	M9x1		114	76	8,0	0800	o
8,10			142	95	10,0	0810	o
8,20	M9x0,75		142	95	10,0	0820	o
8,30			142	95	10,0	0830	o
8,40			142	95	10,0	0840	o
8,50	M10		142	95	10,0	0850	o
8,60		M9x1	142	95	10,0	0860	o
8,70		M9x0,75	142	95	10,0	0870	o
8,80	M10x1,25		142	95	10,0	0880	o
8,90			142	95	10,0	0890	o
9,00	M10x1		142	95	10,0	0900	o
9,10			142	95	10,0	0910	o
9,20	M10x0,75		142	95	10,0	0920	o
9,30			142	95	10,0	0930	o
9,40			142	95	10,0	0940	o
9,50	M11		142	95	10,0	0950	o
9,60		M10x1	142	95	10,0	0960	o
9,70		M10x0,75	142	95	10,0	0970	o
9,80			142	95	10,0	0980	o
9,90			142	95	10,0	0990	o
10,00	M11x1		142	95	10,0	1000	o
10,10			162	114	12,0	1010	o
10,20	M12		162	114	12,0	1020	o
10,30			162	114	12,0	1030	o
10,40			162	114	12,0	1040	o
10,50	M12x1,5		162	114	12,0	1050	o
10,60		M11x1	162	114	12,0	1060	o
10,70			162	114	12,0	1070	o
10,80	M12x1,25		162	114	12,0	1080	o
10,90			162	114	12,0	1090	o
11,00	M12x1		162	114	12,0	1100	o
11,10			162	114	12,0	1110	o
11,20			162	114	12,0	1120	o
11,30			162	114	12,0	1130	o
11,40			162	114	12,0	1140	o
11,50			162	114	12,0	1150	o
11,60		M12x1	162	114	12,0	1160	o
11,70			162	114	12,0	1170	o
11,80			162	114	12,0	1180	o
11,90			162	114	12,0	1190	o
12,00	M14		162	114	12,0	1200	o
12,30			178	133	14,0	1230	o

8xD Максимальная глубина отверстия **4** Ленточки **1300**

VHM

AT

DIN 6537

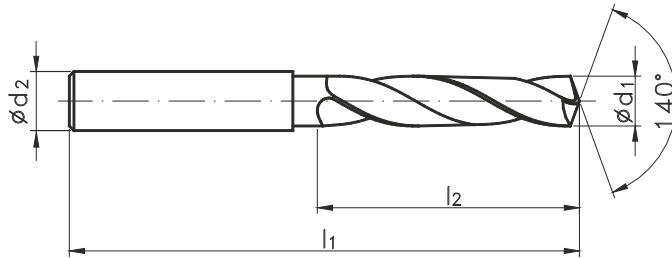

Обрабатываемые материалы



внутреннее охлаждение

IK

Изготовлено из

VHM

Покрытие

AT

d ₁	M MF	M "WGN"	l ₁	l ₂	d ₂ h6	Норма	
						DIN-6537	
						Точность	m7
						INDEX	W9-624063
12,50	M14x1,5		178	133	14,0	1250	o
12,80			178	133	14,0	1280	o
13,00	M14x1		178	133	14,0	1300	o
13,50			178	133	14,0	1350	o
13,80			178	133	14,0	1380	o
14,00	M16, M15x1		178	133	14,0	1400	o
14,50	M16x1,5		203	152	16,0	1450	o
14,80			203	152	16,0	1480	o
15,00	M16x1		203	152	16,0	1500	o
15,50	M18		203	152	16,0	1550	o
15,80			203	152	16,0	1580	o
16,00	M18x2		203	152	16,0	1600	o
16,50	M18x1,5		222	171	18,0	1650	o
16,80			222	171	18,0	1680	o
17,00	M18x1		222	171	18,0	1700	o
17,50	M20		222	171	18,0	1750	o
17,80			222	171	18,0	1780	o
18,00	M20x2		222	171	18,0	1800	o
18,50	M20x1,5		243	190	20,0	1850	o
19,00	M20x1		243	190	20,0	1900	o
19,50	M22		243	190	20,0	1950	o
19,80			243	190	20,0	1980	o
20,00	M22x2		243	190	20,0	2000	o

6



1300micro

VHM

DIN 6539

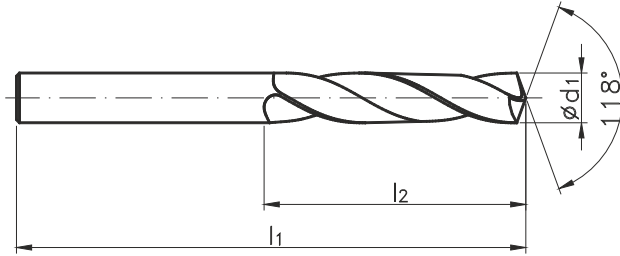

Обрабатываемые материалы



внутреннее охлаждение

-

Изготовлено из

VHM

Покрытие

-

d ₁	M MF	M "WGN"	l ₁	l ₂	Норма	DIN-6539				
					Точность	h7				
					INDEX	W9-801014				
0,75	M1		22	6	0075	●				
0,85	M1,1		24	6	0085	●				
0,90		M1	24	7	0090	●				
0,95	M1,2		24	7	0095	●				
1,00		M1,1	26	7	0100	●				
1,10	M1,4		28	8	0110	●				
1,25	M1,6		30	9	0125	●				
1,28		M1,4	30	9	0128	●				
1,35	M1,7		30	9	0135	●				
1,45	M1,8		32	10	0145	●				
1,47		M1,6	32	10	0147	●				
1,57		M1,7	32	10	0157	●				
1,60	M2		34	11	0160	●				
1,67		M1,8	34	11	0167	●				
1,75	M2,2		34	11	0175	●				
1,85		M2	36	12	0185	●				
1,90	M2,3		36	12	0190	●				
2,00			38	12	0200	●				
2,03		M2,2	38	12	0203	●				
2,05	M2,5		38	12	0205	●				
2,10			38	12	0210	●				
2,15	M2,6	M2,3	38	12	0215	●				
2,20			40	13	0220	●				
2,30			40	13	0230	●				
2,33		M2,5	40	13	0233	●				
2,40			43	14	0240	●				
2,43		M2,6	43	14	0243	●				
2,50	M3		43	14	0250	●				
2,60			43	14	0260	●				
2,70			46	16	0270	●				
2,80		M3	46	16	0280	●				
2,90	M3,5		46	16	0290	●				

6

								1300						
<div style="display: flex; flex-direction: column; gap: 5px;"> <div style="border: 1px solid black; padding: 2px; width: fit-content;">VHM</div> <div style="border: 1px solid black; padding: 2px; width: fit-content;">AT</div> <div style="border: 1px solid black; padding: 2px; width: fit-content;">DIN 6537</div> </div>														
Обрабатываемые материалы														
Исполнение								90°						
Изготовлено из								VHM						
Покрытие								AT						
							Норма	~DIN-6537						
							Точность	m7						
							INDEX	W9-704010						
d ₁	M	l ₁	l ₂	l ₃	d ₂	d ₂ h6								
2,50	M3	62	20	8,8	6	6	0250	●						
3,30	M4	62	24	11,4	6	6	0330	●						
4,20	M5	66	28	13,6	6	6	0420	●						
5,00	M6	79	34	16,5	8	8	0500	●						
6,80	M8	89	47	21,0	10	10	0680	●						
8,50	M10	102	55	25,5	12	12	0850	●						
10,20	M12	107	60	30,0	14	14	1020	●						
12,00	M14	115	65	34,5	16	16	1200	●						
14,00	M16	123	73	38,5	18	18	1400	●						



1300

VHM

AT

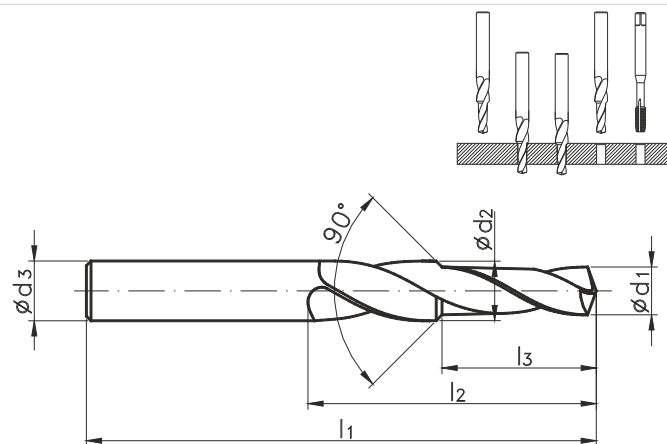
DIN
~6537

Обрабатываемые материалы



Исполнение

90°

Изготовлено из

VHM

Покрытие

AT

d ₁	M MF	l ₁	l ₃	d ₂	d ₂ h6	Норма				
						~DIN-6537				
						Точность	m7			
						INDEX	W9-704010			
2,35	M2,5	60	10	4	4	0235	●			
2,80	M3	62	12	4	4	0280	●			
3,70	M4	64	14	6	6	0370	●			
4,65	M5	80	20	6	6	0465	●			
5,55	M6	80	24	8	8	0555	●			
7,45	M8	80	30	10	10	0745	●			
9,30	M10	90	40	12	12	0930	●			
11,20	M12	100	45	14	14	1120	○			

6

								1300											
<div style="display: flex; flex-direction: column; gap: 5px;"> <div style="border: 1px solid black; padding: 2px; width: fit-content;">VHM</div> <div style="border: 1px solid black; padding: 2px; width: fit-content;">AT</div> <div style="border: 1px solid black; padding: 2px; width: fit-content;">DIN ~6537</div> </div>																			
Обрабатываемые материалы								<table border="1" style="font-size: small;"> <tr> <td style="background-color: #e0e0e0;">P</td> <td style="background-color: #ffffe0;">M</td> <td style="background-color: #ffe0e0;">K</td> </tr> <tr> <td style="background-color: #e0ffe0;">N</td> <td style="background-color: #e0e0ff;">S</td> <td style="background-color: #e0e0e0;">H</td> </tr> </table>		P	M	K	N	S	H				
P	M	K																	
N	S	H																	
Исполнение								180°											
Изготовлено из								VHM											
Покрытие								AT											
							Норма ~DIN-6537												
							Точность m7												
							INDEX W9-714010												
d ₁	M	l ₁	l ₂	l ₃	d ₂	d ₂ h6	0340	●											
3,40	M3	66	28	9	6	6	0450	●											
4,50	M4	80	37	11	8	8	0550	●											
5,50	M5	89	43	13	10	10	0660	●											
6,60	M6	95	47	15	11	12	0900	●											
9,00	M8	110	56	19	15	16	1100	●											
11,00	M10	123	62	23	18	18		●											



5xD Максимальная глубина отверстия

AL

VHM

TB

DIN 6537

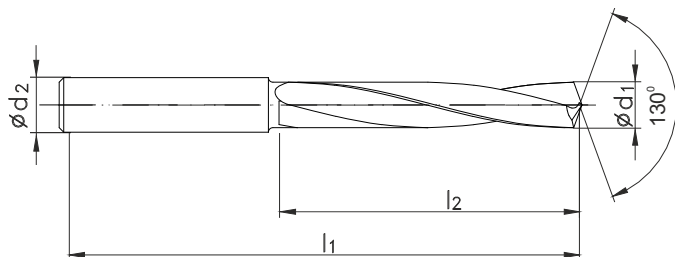

Обрабатываемые материалы



внутреннее охлаждение

IK IK

Изготовлено из

VHM VHM

Покрытие

- TB

d ₁	M MF	M MF "WGN"	l ₁	l ₂	d ₂ h6	Норма	DIN-6537	
						Точность	m7	m7
						INDEX	W9-611733	W9-61B733
3,00			66	28	6,0	0300	o	o
3,10			66	28	6,0	0310	o	o
3,20			66	28	6,0	0320	o	o
3,25		M3,5	66	28	6,0	0325	o	o
3,30	M4		66	28	6,0	0330	o	o
3,40			66	28	6,0	0340	o	o
3,50	M4x0,5		66	28	6,0	0350	o	o
3,60			66	28	6,0	0360	o	o
3,70	M4,5	M4	66	28	6,0	0370	o	o
3,80			74	36	6,0	0380	o	o
3,90			74	36	6,0	0390	o	o
4,00			74	36	6,0	0400	o	o
4,10			74	36	6,0	0410	o	o
4,20	M5	M4,5	74	36	6,0	0420	o	o
4,30			74	36	6,0	0430	o	o
4,40			74	36	6,0	0440	o	o
4,50	M5x0,5		74	36	6,0	0450	o	o
4,60	M5,5		74	36	6,0	0460	o	o
4,65		M5	74	36	6,0	0465	o	o
4,70			74	36	6,0	0470	o	o
4,80			82	44	6,0	0480	o	o
4,90			82	44	6,0	0490	o	o
5,00	M6		82	44	6,0	0500	o	o
5,10		M5,5	82	44	6,0	0510	o	o
5,20	M6x0,75		82	44	6,0	0520	o	o
5,30			82	44	6,0	0530	o	o
5,40			82	44	6,0	0540	o	o
5,50			82	44	6,0	0550	o	o
5,60		M6	82	44	6,0	0560	o	o
5,70			82	44	6,0	0570	o	o
5,80			82	44	6,0	0580	o	o
5,90			82	44	6,0	0590	o	o
6,00	M7		82	44	6,0	0600	o	o
6,10			91	53	8,0	0610	o	o
6,20	M7x0,75		91	53	8,0	0620	o	o
6,30			91	53	8,0	0630	o	o
6,40			91	53	8,0	0640	o	o
6,50			91	53	8,0	0650	o	o
6,60		M7	91	53	8,0	0660	o	o
6,70			91	53	8,0	0670	o	o
6,80	M8		91	53	8,0	0680	o	o
6,90			91	53	8,0	0690	o	o
7,00	M8x1		91	53	8,0	0700	o	o
7,10			91	53	8,0	0710	o	o
7,20	M8x0,75		91	53	8,0	0720	o	o
7,30			91	53	8,0	0730	o	o

6

5xD Максимальная глубина отверстия

AL

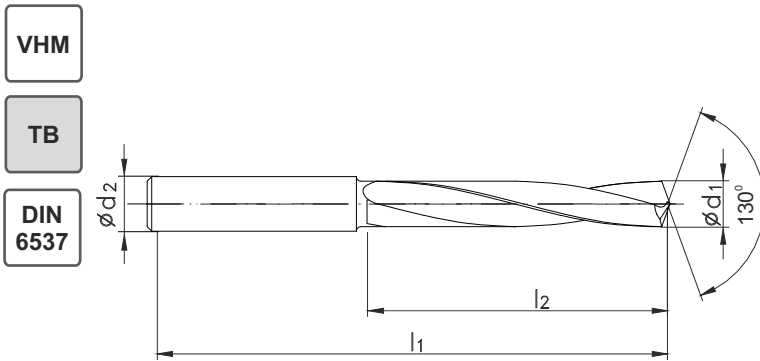

VHM

TB

DIN 6537



Обрабатываемые материалы



внутреннее охлаждение

IK

IK

Изготовлено из

VHM

VHM

Покрытие

-

TB

d ₁	M MF	M MF "WGN"	l ₁	l ₂	d ₂ h6	Норма	DIN-6537	
						Точность	m7	m7
						INDEX	W9-611733	W9-61B733
7,40			91	53	8,0	0740	o	o
7,45		M8	91	53	8,0	0745	o	o
7,50			91	53	8,0	0750	o	o
7,60		M8x1	91	53	8,0	0760	o	o
7,70			91	53	8,0	0770	o	o
7,80	M9		91	53	8,0	0780	o	o
7,90			91	53	8,0	0790	o	o
8,00	M9x1		91	53	8,0	0800	o	o
8,10			103	61	10,0	0810	o	o
8,20	M9x0,75		103	61	10,0	0820	o	o
8,30			103	61	10,0	0830	o	o
8,40			103	61	10,0	0840	o	o
8,45		M9	103	61	10,0	0845	o	o
8,50	M10		103	61	10,0	0850	o	o
8,60		M9x1	103	61	10,0	0860	o	o
8,70		M9x0,75	103	61	10,0	0870	o	o
8,80	M10x1,25		103	61	10,0	0880	o	o
8,90			103	61	10,0	0890	o	o
9,00	M10x1		103	61	10,0	0900	o	o
9,10			103	61	10,0	0910	o	o
9,20	M10x0,75		103	61	10,0	0920	o	o
9,30			103	61	10,0	0930	o	o
9,35		M10	103	61	10,0	0935	o	o
9,40			103	61	10,0	0940	o	o
9,45		M10x1,25	103	61	10,0	0945	o	o
9,50	M11		103	61	10,0	0950	o	o
9,60		M10x1	103	61	10,0	0960	o	o
9,70		M10x0,75	103	61	10,0	0970	o	o
9,80			103	61	10,0	0980	o	o
9,90			103	61	10,0	0990	o	o
10,00	M11x1		103	61	10,0	1000	o	o
10,10			118	71	12,0	1010	o	o
10,20	M12		118	71	12,0	1020	o	o
10,30			118	71	12,0	1030	o	o
10,40			118	71	12,0	1040	o	o
10,50	M12x1,5		118	71	12,0	1050	o	o
10,60		M11x1	118	71	12,0	1060	o	o
10,70			118	71	12,0	1070	o	o
10,80	M12x1,25		118	71	12,0	1080	o	o
10,90			118	71	12,0	1090	o	o
11,00	M12x1		118	71	12,0	1100	o	o
11,10			118	71	12,0	1110	o	o
11,20			118	71	12,0	1120	o	o
11,25		M12	118	71	12,0	1125	o	o
11,30			118	71	12,0	1130	o	o
11,35		M12x1,5	118	71	12,0	1135	o	o

6



5xD Максимальная глубина отверстия

AL

VHM

TB

DIN 6537

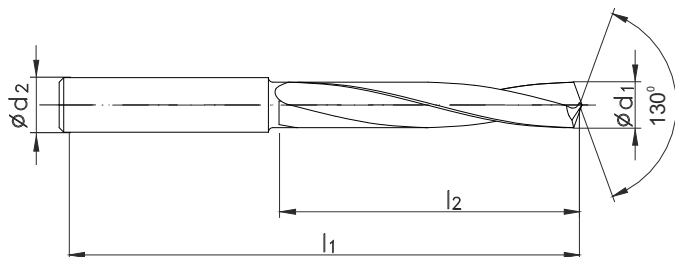

Обрабатываемые материалы



внутреннее охлаждение

IK IK



Изготовлено из

VHM VHM

Покрытие

- TB

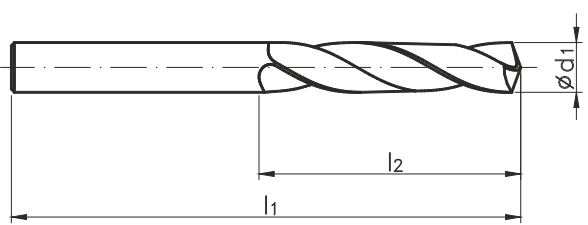
d ₁	M MF	M MF "WGN"	l ₁	l ₂	d ₂ h6	DIN-6537		
						Точность	m7	m7
						INDEX	W9-611733	W9-61B733
11,40			118	71	12,0	1140	o	o
11,45		M12x1,25	118	71	12,0	1145	o	o
11,50			118	71	12,0	1150	o	o
11,60		M12x1	118	71	12,0	1160	o	o
11,70			118	71	12,0	1170	o	o
11,80			118	71	12,0	1180	o	o
11,90			118	71	12,0	1190	o	o
12,00	M14		118	71	12,0	1200	o	o
12,30			124	77	14,0	1230	o	o
12,50	M14x1,5		124	77	14,0	1250	o	o
12,80	M14x1,25		124	77	14,0	1280	o	o
13,00	M14x1	M14	124	77	14,0	1300	o	o
13,50			124	77	14,0	1350	o	o
13,80			124	77	14,0	1380	o	o
14,00	M16; M15x1		124	77	14,0	1400	o	o
14,50	M16x1,5		133	83	16,0	1450	o	o
14,80			133	83	16,0	1480	o	o
15,00	M16x1	M16	133	83	16,0	1500	o	o
15,35		M16x1,5	133	83	16,0	1535	o	o
15,50	M18		133	83	16,0	1550	o	o
15,80			133	83	16,0	1580	o	o
16,00	M18x2		133	83	16,0	1600	o	o
16,50	M18x1,5		143	93	18,0	1650	o	o
16,80		M18	143	93	18,0	1680	o	o
17,00	M18x1		143	93	18,0	1700	o	o
17,35		M18x1,5	143	93	18,0	1735	o	o
17,50	M20		143	93	18,0	1750	o	o
17,80			143	93	18,0	1780	o	o
18,00	M20x2		143	93	18,0	1800	o	o
18,50	M20x1,5		153	101	20,0	1850	o	o
18,80		M20	153	101	20,0	1880	o	o
19,00	M20x1		153	101	20,0	1900	o	o
19,35		M20x1,5	153	101	20,0	1935	o	o
19,50	M22		153	101	20,0	1950	o	o
19,80			153	101	20,0	1980	o	o
20,00	M22x2		153	101	20,0	2000	o	o

					INOX																
<div style="display: flex; align-items: center;"> <div style="border: 1px solid black; padding: 2px; margin-right: 5px;">HSSE</div> <div style="border: 1px solid black; padding: 2px; margin-right: 5px; background-color: #c08040; color: white;">TN2</div> <div style="border: 1px solid black; padding: 2px; margin-right: 5px;">DIN 338</div>  </div>																					
Обрабатываемые материалы					<table border="1" style="font-size: small;"> <tr> <td>P</td><td>M</td><td>K</td> <td>P</td><td>M</td><td>K</td> </tr> <tr> <td>N</td><td>S</td><td></td> <td>N</td><td>S</td><td></td> </tr> </table>		P	M	K	P	M	K	N	S		N	S				
P	M	K	P	M	K																
N	S		N	S																	
внутреннее охлаждение					-																
Изготовлено из					HSSE		HSSE														
Покрытие					-		TN2														
d ₁	M MF	M MF "WGN"	l ₁	l ₂	Норма	DIN-338															
					Точность	h8	h8														
						INDEX	W2-101811	W2-103811													
1,00		M1,1	34	12	0100	●	○														
1,10	M1,4	M1,2	36	14	0110	●	○														
1,20			38	16	0120	●	○														
1,30			38	16	0130	●	○														
1,40			40	18	0140	●	○														
1,50			40	18	0150	●	○														
1,60	M2		43	20	0160	●	○														
1,70			43	20	0170	●	○														
1,80			46	22	0180	●	○														
1,83		M2	46	22	0183	○	○														
1,90	M2,3		46	22	0190	●	○														
2,00		M2,2	49	24	0200	●	●														
2,05	M2,5		49	24	0205	○	○														
2,10			49	24	0210	●	○														
2,20			53	27	0220	●	○														
2,30		M2,5	53	27	0230	●	○														
2,40			57	30	0240	●	○														
2,50	M3		57	30	0250	●	●														
2,60			57	30	0260	●	○														
2,70			61	33	0270	●	○														
2,80		M3	61	33	0280	●	○														
2,90	M3,5		61	33	0290	●	○														
3,00			61	33	0300	●	●														
3,10			65	36	0310	●	○														
3,20			65	36	0320	●	●														
3,25		M3,5	65	36	0325	○	○														
3,30	M4		65	36	0330	●	●														
3,40			70	39	0340	●	○														
3,50	M4x0,5		70	39	0350	●	●														
3,60			70	39	0360	●	○														
3,70	M4,5	M4	70	39	0370	●	○														
3,80			75	43	0380	●	○														
3,90			75	43	0390	●	○														
4,00			75	43	0400	●	●														
4,10			75	43	0410	●	○														
4,20	M5		75	43	0420	●	●														
4,30			80	47	0430	●	○														
4,40			80	47	0440	●	○														
4,50	M5x0,5		80	47	0450	●	●														
4,60	M5,5		80	47	0460	●	○														
4,65		M5	80	47	0465	○	○														
4,70			80	47	0470	●	○														
4,80			86	52	0480	●	○														
4,90			86	52	0490	●	○														
5,00	M6		86	52	0500	●	●														
5,10			86	52	0510	●	●														



HSSE

TN2

DIN 338

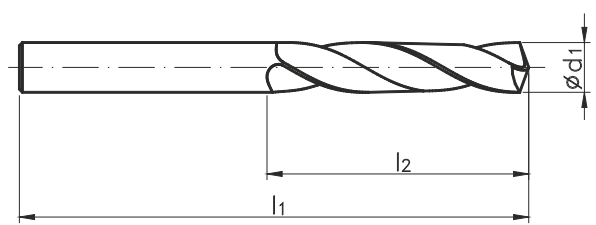

INOX



Обрабатываемые материалы

P	M	K	P	M	K
N	S		N	S	

внутреннее охлаждение

- -

Изготовлено из



HSSE HSSE

Покрытие

- TN2

d ₁	M MF	M MF "WGN"	l ₁	l ₂	Норма	DIN-338	
					Точность	h8	h8
					INDEX	W2-101811	W2-103811
5,20	M6x0,75		86	52	0520	●	○
5,30			86	52	0530	●	○
5,40			93	57	0540	●	○
5,50			93	57	0550	●	●
5,55			93	57	0555	○	○
5,60		M6	93	57	0560	●	○
5,70			93	57	0570	●	○
5,80			93	57	0580	●	○
5,90			93	57	0590	●	○
6,00	M7		93	57	0600	●	●
6,10			101	63	0610	●	○
6,20	M7x0,75		101	63	0620	●	○
6,30			101	63	0630	●	○
6,40			101	63	0640	●	○
6,50			101	63	0650	●	●
6,60		M7	101	63	0660	●	○
6,70			101	63	0670	●	○
6,80	M8		109	69	0680	●	●
6,90			109	69	0690	●	●
7,00	M8x1		109	69	0700	●	●
7,10			109	69	0710	●	○
7,20	M8x0,75		109	69	0720	●	○
7,30			109	69	0730	●	○
7,40		M8	109	69	0740	●	○
7,50			109	69	0750	●	●
7,60			117	75	0760	●	○
7,70			117	75	0770	●	○
7,80	M9		117	75	0780	●	○
7,90			117	75	0790	●	○
8,00	M9x1		117	75	0800	●	●
8,10			117	75	0810	●	○
8,20	M9x0,75		117	75	0820	●	●
8,30			117	75	0830	●	○
8,40			117	75	0840	●	○
8,50	M10		117	75	0850	●	●
8,60			125	81	0860	●	○
8,70			125	81	0870	●	○
8,80	M10x1,25		125	81	0880	●	○
8,90			125	81	0890	●	○
9,00	M10x1		125	81	0900	●	●
9,10			125	81	0910	●	○
9,20	M10x0,75		125	81	0920	●	○
9,30		M10	125	81	0930	●	○
9,40			125	81	0940	○	○
9,50	M11		125	81	0950	●	●
9,60			133	87	0960	○	○

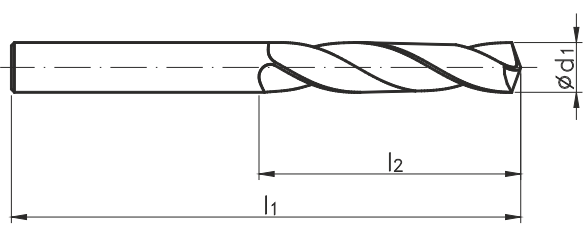
6

					INOX																
<div style="display: flex; align-items: center;"> <div style="border: 1px solid black; padding: 2px; margin-right: 10px;">HSSE</div> <div style="border: 1px solid black; padding: 2px; margin-right: 10px; background-color: #c08040; color: white;">TN2</div> <div style="border: 1px solid black; padding: 2px; margin-right: 10px;">DIN 338</div>  </div>																					
Обрабатываемые материалы					<table border="1"> <tr> <td>P</td><td>M</td><td>K</td> <td>P</td><td>M</td><td>K</td> </tr> <tr> <td>N</td><td>S</td><td></td> <td>N</td><td>S</td><td></td> </tr> </table>		P	M	K	P	M	K	N	S		N	S				
P	M	K	P	M	K																
N	S		N	S																	
внутреннее охлаждение					-																
Изготовлено из					HSSE HSSE																
Покрытие					- TN2																
d ₁	M MF	M MF "WGN"	l ₁	l ₂	Норма	DIN-338															
					Точность	h8	h8														
						INDEX	W2-101811			W2-103811											
9,70			133	87	0970	●	○														
9,80			133	87	0980	●	○														
9,90			133	87	0990	○	○														
10,00	M11x1		133	87	1000	●	●														
10,10			133	87	1010	●	○														
10,20	M12		133	87	1020	●	●														
10,30			133	87	1030	●	○														
10,40			133	87	1040	○	○														
10,50	M12x1,5		133	87	1050	●	●														
10,60			133	87	1060	●	○														
10,70			142	94	1070	○	○														
10,80	M12x1,25		142	94	1080	●	○														
10,90			142	94	1090	○	○														
11,00	M12x1		142	94	1100	●	●														
11,10			142	94	1110	○	○														
11,20		M12	142	94	1120	●	○														
11,30			142	94	1130	○	○														
11,40			142	94	1140	○	○														
11,50			142	94	1150	●	○														
11,60			142	94	1160	○	○														
11,70			142	94	1170	○	○														
11,80			142	94	1180	●	○														
11,90			151	101	1190	○	○														
12,00	M14		151	101	1200	●	●														
12,10			151	101	1210	●	○														
12,20			151	101	1220	●	○														
12,30			151	101	1230	●	○														
12,50	M14x1,5		151	101	1250	●	●														
12,60			151	101	1260	○	○														
12,70			151	101	1270	●	○														
12,80	M14x1,25		151	101	1280	●	○														
12,90			151	101	1290	○	○														
13,00	M14x1	M14	151	101	1300	●	●														
13,20			151	101	1320	●	○														
13,50			160	108	1350	●	○														
13,80			160	108	1380	○	○														
14,00	M16;M15x1		160	108	1400	●	●														
14,50	M16x1,5		169	114	1450	●	○														
15,00	M16x1	M16	169	114	1500	●	●														
15,50	M18		178	120	1550	○	○														
16,00	M18x2		178	120	1600	●	●														



HSS

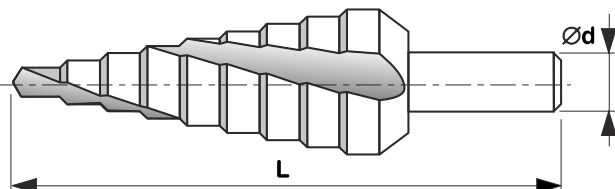

Обрабатываемые материалы

-

внутреннее охлаждение

-



Изготовлено из

HSS

Покрытие

-

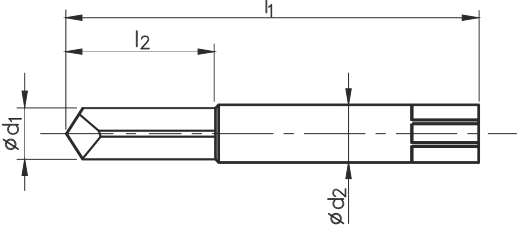
d	L	D	INDEX		Имя
8	75	4/6/8/10/12/14/16/18/20	W1-641010-0420	●	Nr 1 HSS 4-20mm
10	100	6/8/10/12/14/16/18/20/22/24/26/28/30	W1-641020-0630	●	Nr 2 HSS 6-30mm
10	100	6/9/13/16/19/21/23/26/29/32/35/38	W1-641030-0638	●	Nr 3 HSS 6-38mm
10	100	6/9/11,4/14/17,25/19/21,25/24/26,75/30/33/35,7	W1-642030-0636	●	PG 3 HSS 6-36mm
10	100	6/9/12,5/15,2/18,6/20,4/22,5/26/28,3/30,5/34/37	W1-642040-0637	●	PG 4 HSS 6-37mm
8	75	4/6/8/10/12/14/16/18/20	W1-648010-0420	●	Nr 1 HSS 4-20mm
10	100	6/8/10/12/14/16/18/20/22/24/26/28//30	W1-648020-0630	●	Nr 2 HSS 6-30mm
10	100	6/9/13/16/19/21/23/26/29/32/35/38	W1-648030-0638	○	Nr 3 HSS 6-38mm
10	100	6/9/11,4/14/17,25/19/21,25/24/26,75/30/33/35,7	W1-645030-0636	●	PG 3 HSS 6-36mm
10	100	6/9/12,5/15,2/18,6/20,4/22,5/26/28,3/30,5/34/37	W1-645040-0637	●	PG 4 HSS 6-37mm

<div style="display: flex; align-items: center;"> <div style="border: 1px solid black; padding: 2px; margin-right: 10px;">VHM</div> <div style="background-color: #800040; color: white; padding: 2px; margin-right: 10px;">AT</div>  </div>						WDG											
																	
Обрабатываемые материалы						<table border="1" style="font-size: small;"> <tr><td>P</td><td>M</td><td>K</td></tr> <tr><td>N</td><td>S</td><td>H</td></tr> </table>						P	M	K	N	S	H
P	M	K															
N	S	H															
внутреннее охлаждение						-											
Изготовлено из						VHM											
Покрытие						AT											
d ₁	M	l ₁ ±2	l ₂ ±2	d ₂	Норма		W9-900002										
					Точность	INDEX											
2,5	M3	38	10	3	0250		●										
3,3	M4	46	14	4	0330		●										
4,2	M5	50	19	5	0420		●										
5,0	M6	50	23	6	0500		●										
6,8	M8	60	23	8	0680		●										
8,5	M10	80	25	10	0850		●										
10,2	M12	80	35	12	1020		●										

кормить		fz		fz		fz		fz		fz	
Vc m/min		φ3,3-6,8		φ6,8-10,2		φ10,2-14,0		φ14,0-15,5		φ15,5-17,5	
od	do	od	do	od	do	od	do	od	do	od	do
10	12	0,040	0,08	0,08	0,110	0,110	0,140	0,140	0,150	0,150	0,170

Инструкция по эксплуатации:

1. Заготовка должна быть зажата очень стабильно и безопасно.
 2. Выстающая часть метчика должна находиться в одной плоскости с заготовкой.
 3. Центровочное отверстие необходимо сформировать с помощью нескольких начальных подходов в насверливании первоначальной точки
 4. Удаление метчика можно производить при помощи станка с ЧПУ с охлаждением (Внимание: есть риск заклинивания), а также вручную на настольном или напольном сверлильном станке. Необходимо многократное удаление стружки.
 5. Удалите остатки стружки сжатым воздухом или скребком.
 6. Нарежьте резьбу
 7. После нарезания резьбы проверьте точность размеров калибром. От 1 до 5 метчиков может быть удалено одним сверлом для удаления сломанных метчиков. Перезаточка такого сверла является не экономичной.
- Благодаря шестигранной форме сверло может быть зажато как в трех-кулачковых, так и в четырех-кулачковых патронах. При условии правильного использования отверстие в заготовке не будет повреждено независимо от используемого материала.



Сверла для удаления сломанных метчиков 208

Для центровки отверстия и получения фаски за одну операцию

VHM
TN2
HSSE

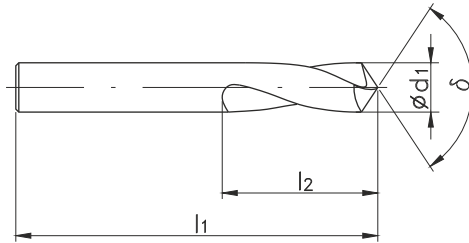

Обрабатываемые материалы

P	M	K	P	M	K	P	M	K	P	M	K
N	S	H	N	S	H	N	S	H	N	S	H

внутреннее охлаждение

- - - -

Изготовлено из

HSSE HSSE HSSE VHM

Покрытие

- TN2 TN2 -

Точечный угол

90° 90° 120° 142°

d ₁	δ90 / δ120°		δ142°		Норма				
	l ₁	l ₂	l ₁	l ₂	Точность				
					INDEX	W2-001012	W2-003012	W2-003013	W9-001014
3,0	46	12	45	12,0	0300	●	●	○	○
4,0	55	12	50	15,0	0400	●	●	●	●
5,0	62	15	50	18,0	0500	●	●	●	●
6,0	66	20	50	21,0	0600	●	●	○	○
8,0	79	25	60	25,0	0800	●	○	○	○
10,0	89	25	70	27,0	0100	●	○	○	○
12,0	102	30	70	27,0	0120	●	●	●	●
14,0	107	34	75	30,0	0140	○	○	○	○
16,0	115	35	75	30,0	0160	●	○	○	○

Для центровки

HSS

DIN 333 A

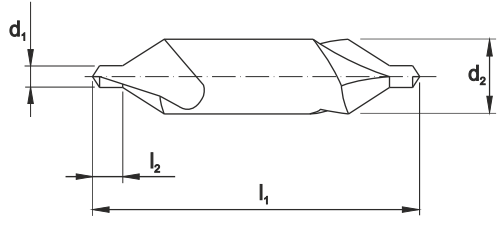

Обрабатываемые материалы



внутреннее охлаждение

-

Изготовлено из

HSS

Покрытие

-

Точечный угол

60°

d ₁	d ₂	l ₁	l ₂ min-max	Норма	DIN-333 A								
				Точность									
				INDEX	W1-011021								
0,8	3,15	25	1,0~1,3	0080	●								
1,0	3,15	31	1,3~1,7	0100	●								
1,25	3,15	31	1,6~2,0	0125	●								
1,6	4,0	35	2,0~2,6	0160	●								
2,0	5,0	40	2,5~3,1	0200	●								
2,5	6,3	45	3,1~3,8	0250	●								
3,15	8,0	50	3,9~4,6	0315	●								
4,0	10,0	55	5,0~5,9	0400	○								
5,0	12,5	63	6,3~7,2	0500	●								
6,3	16,0	71	8,0~8,9	0630	●								
8,0	20,0	80	10,1~11,1	0800	●								
10,0	25,0	100	12,8~13,8	1000	●								



Для снятия фаски у резьбовых отверстий

VHM

AT

DIN
6537L

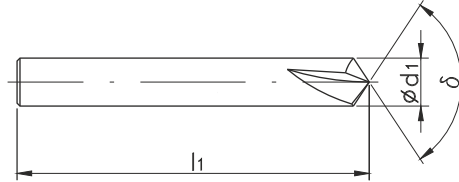

Обрабатываемые материалы



внутреннее охлаждение

- -

Изготовлено из

VHM VHM

Покрытие

AT AT

Точечный угол

60° 90°

d ₁	l ₁	z	Норма DIN-6537L			
			Точность			
			INDEX	W9-054011	W9-054012	
4,0	54	4	0400	●	●	
6,0	57	4	0600	●	●	
8,0	63	5	0800	●	●	
10,0	72	6	1000	●	●	
12,0	83	6	1200	●	●	
16,0	92	6	1600	●	●	
20,0	104	6	2000	○	○	

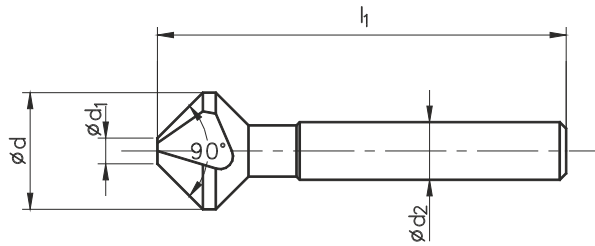
HSS
TC
TN2
DIN 335

Обрабатываемые материалы



внутреннее охлаждение

- - - -

Изготовлено из

HSS HSS HSSE HSSE HSSE (8%Co)

Покрытие

- TN2 - TN2 TC

$\varnothing d$	$\varnothing d_1$	$\varnothing d_2$	l_1	Норма	DIN-335				
				Точность					
				INDEX	T1-040010	T1-043010	T2-040010	T2-043010	T2-045110
6,3	1,50	5	45	0630	○	○	●	●	●
8,3	2,00	6	50	0830	○	○	●	●	●
10,4	2,50	6	50	1040	○	○	●	●	●
12,4	2,80	8	56	1240	○	○	●	●	●
16,5	3,20	10	60	1650	○	○	●	●	●
20,5	3,50	10	63	2050	○	○	●	●	●
25,0	3,80	10	67	2500	○	○	●	●	●
30,0	4,20	12	71	3000	○	○	●	●	●
37,0	5,00	16	80	3700	○	○	○	○	○
40,0	10,00	16	80	4000	○	○	○	○	○
45,00	12,00	20	95	4500	○	○	○	○	○
50,00	14,00	20	95	5000	○	○	○	○	○

6

Комплект зенковок: 208

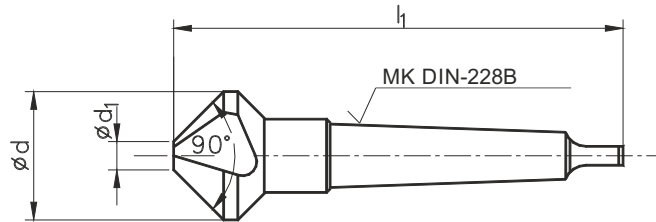

HSS
**DIN
335**

Обрабатываемые материалы



внутреннее охлаждение

-

Изготовлено из

HSS

Покрытие

-

d	d ₁	l ₁	MK DIN-228B	INDEX	T1-040210		
37	4,8	118	2	0037	●		
d	d ₁	l ₁	MK DIN-228B	INDEX	T1-040310		
50	14	150	3	0050	●		
63,0	16,00	180	4,0	0063	●		
80,0	20,00	180	4,0	0080	●		

						PF	
$\varnothing D_1$	$\varnothing D_c$	κ	A	B	Z	INDEX	
40	34	30°	14,5	25,5	1	T9-100013-0400	●
56	46	45°	20,5	20,5	2	T9-100012-0560	●
72	55	60°	14,5	14,5	2	T9-100011-0720	●

Аксессуары

Маркирование	INDEX
Пластинка AN330	T9-104000-0127
Крепежный винт	T9-100001-0000
Ключ	T9-100002-0000

Параметры обработки

Материал	Подача f_z (мм/зуб)
Углеродистая сталь	0,1~0,25
жаропрочные сплавы	0,1~0,2
Инструментальная сталь	0,1~0,2
нержавеющий	0,1~0,25
Чугун	0,1~0,25

Величина хода инструмента по оси Z (мм)

- Для фаски 30°

Диаметр отверстия d (мм)	Размер фаски C (мм)						
	0,5	1	1,5	2	2,5	3	3,5
5	0,6	1,1	1,6	2,1			
6	0,9	1,4	1,9	2,4			
6,8	1,1	1,6	2,1	2,6			
8	1,4	1,9	2,4	2,9			
8,5	1,6	2,1	2,6	3,1			
10	2,0	2,5	3,0	3,5	4,0	4,5	5,0
10,2	2,1	2,6	3,1	3,6	4,1	4,6	5,1
12	2,6	3,1	3,6	4,1	4,6	5,1	5,6
16	3,7	4,2	4,7	5,2	5,7	6,2	6,7
17,5	4,2	4,7	5,2	5,7	6,2	6,7	7,2
20	4,9	5,4	5,9	6,4	6,9	7,4	7,9
21	5,2	5,7	6,2	6,7	7,2	7,7	8,2
24	6,1	6,6	7,1	7,6	8,1	8,6	9,1
30	7,8	8,3	8,8	9,3	9,8	10,3	10,8
33	8,7	9,2	9,7	10,2	10,7	11,2	11,7
36	9,5	10,0	10,5	11,0	11,5	12,0	12,5
38	10,1	10,6	11,1	11,6	12,1	12,6	13,1
42	11,2	11,7	12,2	12,7	13,2	13,7	14,2
46	12,4	12,9	13,4	13,9	14,4		
48	13,0	13,5	14	14,5			
52	14,1						

- Для фаски 45°

Диаметр отверстия d (мм)	Размер фаски C (мм)							
	0,5	1	1,5	2	2,5	3	3,5	4
5	0,8	1,3	1,8	2,3	2,8			
6	1,7	2,2	2,7	3,2	3,7			
6,8	2,4	2,9	3,4	3,9	4,4			
8	3,4	3,9	4,4	4,9	5,4			
8,5	3,8	4,3	4,8	5,3	5,8			
10	5,1	5,6	6,1	6,6	7,1	7,6	8,1	8,6
10,2	5,3	5,8	6,3	6,8	7,3	7,8	8,3	8,8
12	6,9	7,4	7,9	8,4	8,9	9,4	9,9	10,4
16	10,3	10,8	11,3	11,8	12,3	12,8	13,3	13,8
17,5	11,6	12,1	12,6	13,1	13,6	14,1	14,6	15,1
20	13,7	14,2	14,7	15,2	15,7	16,2	16,7	17,2
21	14,6	15,1	15,6	16,1	16,6	17,1	17,6	18,1
24	17,2	17,7	18,2	18,7	19,2	19,7	20,2	20,7
30	22,4	22,9	23,4	23,9	24,4	24,9	25,4	
33	24,9	25,4						

- Для фаски 60°

Диаметр отверстия d (мм)	Размер фаски C (мм)						
	0,5	1	1,5	2	3	4	5
5	0,7	1,2	1,7	2,2	3,2		
6	1,2	1,7	2,2	2,7	3,7		
6,8	1,6	2,1	2,6	3,1	4,1		
8	2,2	2,7	3,2	3,7	4,7		
8,5	2,4	2,9	3,4	3,9	4,9		
10	3,2	3,7	4,2	4,7	5,7	6,7	7,7
10,2	3,3	3,8	4,3	4,8	5,8	6,8	7,8
12	4,2	4,7	5,2	5,7	6,7	7,7	8,7
14	5,2	5,7	6,2	6,7	7,7	8,7	9,7
16	6,2	6,7	7,2	7,7	8,7	9,7	10,7
17,5	6,9	7,4	7,9	8,4	9,4	10,4	11,4
20	8,2	8,7	9,2	9,7	10,7	11,7	12,7
21	8,7	9,2	9,7	10,2	11,2	12,2	13,2
24	10,2	10,7	11,2	11,7	12,7	13,7	14,7
30	13,2	13,7	14,2	14,7	15,7	16,7	17,7
33	14,7	15,2	15,7	16,2	17,2	18,2	19,2
36	16,2	16,7	17,2	17,7	18,7		
42	19,2	19,7	20,2				

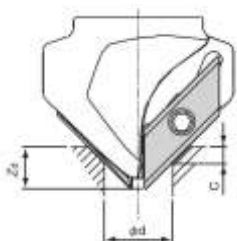

Примечание:

В случае когда глубина отверстия меньше глубины врезания по оси Z (Z_d), следует соблюдать осторожность, чтобы не произошло столкновения торцевой части инструмента с дном отверстия.

Техническая информация

- При снятии фасок у отверстий малого диаметра, либо при работе торцевой частью инструмента следует выбирать скорость ближе верхней границы диапазона скоростей в таблице. И наоборот, в случае отверстий большого диаметра, либо при работе основной частью инструмента следует выбирать скорость ближе нижней границы диапазона скоростей в таблице.
- При выполнении операции по снятию фаски у отверстий малых диаметров (меньше 10 мм) не следует прерывать процесс путем отнимания инструмента от обрабатываемой поверхности.
- Если диаметр отверстия меньше чем $\varnothing 10$ мм, либо при обработке торцевой частью инструмента, подача должна быть в пределах 0.15 мм/зуб.

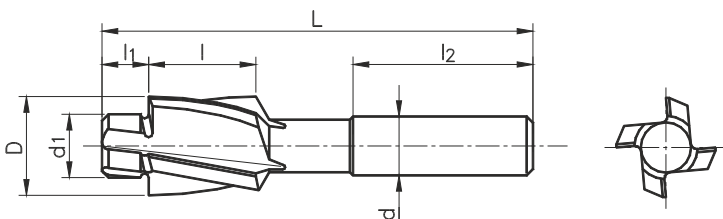
HSS



DIN-373



Исполнение									N	F	M
Направление									в отверстия под резьбу	в прецизионном отверстии	в отверстия средней точности
Тип отверстия											
Изготовлены из									HSS	HSS	HSS
D	d ₁	d	l	l ₁	l ₂	L	M	Норма	DIN-373		
z9	e8	h9						Точность			
								INDEX	T1-044010		
6,0	2,5	5,0	14	3,0	31,5	71	M3	6025	●		
6,5	2,9	5,0	14	3,5	31,5	71	M3,5	6529	●		
8,0	3,3	5,0	14	4,0	31,5	71	M4	8033	●		
10,0	4,2	8,0	18	5,0	35,5	80	M5	1042	●		
11,0	5,0	8,0	18	6,0	35,5	80	M6	1150	●		
15,0	6,8	12,5	22	8,0	40,0	100	M8	1568	●		
18,0	8,5	12,5	22	10,0	40,0	100	M10	1885	●		
20,0	10,2	12,5	22	12,0	40,0	100	M12	2010	●		

D	d ₁	d	l	l ₁	l ₂	L	M	Норма	DIN-373	
z9	e8	h9						Точность		
								INDEX	T1-045010	
6,0	3,2	5,0	14	3,0	31,5	71	M3	6032	●	
6,5	3,7	5,0	14	3,5	31,5	71	M3,5	6537	●	
8,0	4,3	5,0	14	4,0	31,5	71	M4	8043	●	
10,0	5,3	8,0	18	5,0	35,5	80	M5	1053	●	
11,0	6,4	8,0	18	6,0	35,5	80	M6	1164	●	
15,0	8,4	12,5	22	8,0	40,0	100	M8	1584	●	
18,0	10,5	12,5	22	10,0	40,0	100	M10	1810	●	
20,0	13,0	12,5	22	12,0	40,0	100	M12	2013	●	

D	d ₁	d	l	l ₁	l ₂	L	M	Норма	DIN-373	
z9	e8	h9						Точность		
								INDEX	T2-046010	
6,0	3,4	5,0	14	3,0	31,5	71	M3	6034	●	
6,5	3,9	5,0	14	3,5	31,5	71	M3,5	6539	●	
8,0	4,5	5,0	14	4,0	31,5	71	M4	8045	●	
10,0	5,5	8,0	18	5,0	35,5	80	M5	1055	●	
11,0	6,6	8,0	18	6,0	35,5	80	M6	1166	●	
15,0	9,0	12,5	22	8,0	40,0	100	M8	1590	●	
18,0	11,0	12,5	22	10,0	40,0	100	M10	1811	●	
20,0	14,0	12,5	22	12,0	40,0	100	M12	2014	●	

6

HSS

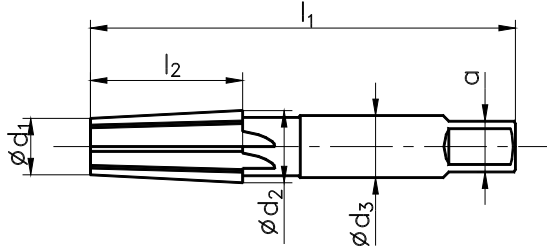

ASME B94,2-1995



Качество материала

HSS

выполнение

C

nom	d ₁	d ₂	d ₃	l ₁	l ₂	a	Норма	T1-030010
							Точность	
							INDEX	
1/4	10,30	12,00	14,3	62	27	10,7	0027	●
3/8	13,70	15,40	17,5	65	27	13,5	0029	●
1/2	16,90	19,10	17,5	79	35	13,0	0031	●
3/4	22,25	24,40	23,0	82	35	17,5	0035	●

Информация касательно размеров отверстий под коническую резьбу в техническом разделе каталога 267

6



КАЛИБРЫ



A	MSBa	Гладкие калибры-пробки	161
	MSBa под резьбу	Гладкие калибры-пробки	162
M	MSBg	Резьбовые калибры-пробки	163
	MSRh	Проходной резьбовой калибр-кольцо	163
	MSRk	Непроходной резьбовой калибр-кольцо	163
MF	MSBg	Резьбовые калибры-пробки	164-165
	MSRh	Проходной резьбовой калибр-кольцо	164-165
	MSRk	Непроходной резьбовой калибр-кольцо	164-165
UNC	MSBg	Резьбовые калибры-пробки	166
	MSRh	Проходной резьбовой калибр-кольцо	166
	MSRk	Непроходной резьбовой калибр-кольцо	166
UNF	MSBg	Резьбовые калибры-пробки	167
	MSRh	Проходной резьбовой калибр-кольцо	167
	MSRk	Непроходной резьбовой калибр-кольцо	167
G	MSBg	Резьбовые калибры-пробки	168
	MSRh	Проходной резьбовой калибр-кольцо	168
	MSRk	Непроходной резьбовой калибр-кольцо	168
R Rc/Rp	MSXa	Резьбовые калибры-пробки	169
	MSXc	Проходной резьбовой калибр-кольцо	169
BSW	MSBg	Резьбовые калибры-пробки	170
	MSRh	Проходной резьбовой калибр-кольцо	170
	MSRk	Непроходной резьбовой калибр-кольцо	170
Pg	MSBg	Резьбовые калибры-пробки	171
	MSRh	Проходной резьбовой калибр-кольцо	171
	MSRc	Непроходной резьбовой калибр-кольцо	171
NPT	MSXa	Резьбовые калибры-пробки	172
	MSXc	Резьбовые калибры-пробки	172
Tr	MSBg	Резьбовые калибры-пробки	173
	MSRk	Проходной резьбовой калибр-кольцо	173
	MSRk	Непроходной резьбовой калибр-кольцо	173

Размеры калибра согласно
норме PN-72/M-02140

Обозначение		MSBa	MSBa				
Тип		GO / NOGO	GO / NOGO				
ном.	Точность	H7	H8				
	INDEX	S3-100111	S3-100112				
1	0010	●	○				
1,2	0012	●	○				
1,5	0015	●	○				
1,8	0018	●	○				
2	0020	●	○				
2,2	0022	●	○				
2,5	0025	●	○				
2,8	0028	●	○				
3	0030	●	○				
3,5	0035	○	○				
4	0040	●	○				
4,5	0045	○	○				
5	0050	●	○				
6	0060	●	○				
7	0070	○	○				
8	0080	●	○				
9	0090	○	○				
10	0100	●	○				
12	0120	●	○				
14	0140	●	○				
16	0160	●	○				
18	0180	●	○				
20	0200	●	○				
22	0220	●	○				
24	0240	●	○				
25	0250	●	○				
26	0260	●	○				
27	0270	○	○				
28	0280	●	○				
30	0300	●	○				
32	0320	●	○				
33	0330	●	○				
34	0340	●	○				
35	0350	●	○				
36	0360	●	○				
37	0370	●	○				
38	0380	●	○				
40	0400	●	○				
42	0420	●	○				
44	0440	○	○				
45	0450	●	○				
46	0460	○	○				
47	0470	●	○				
48	0480	○	○				
50	0500	●	○				
52	0520	○	○				

7



Проходные калибры для резьбы, больше чем 52, обозначаются MSCb, а не проходные - MSCc, и изготавливаются с отдельными ручками

Размеры калибра согласно норме ISO 1502



Обозначение		MSBa под резьбу					MSBa под резьбу				
Тип		GO / NOGO					GO / NOGO				
Точность		6H					6G				
M	P	Внутренний диаметр резьбы (6H)		INDEX	S3-100161	Внутренний диаметр резьбы (6G)		INDEX	S3-100162		
		min	max			min	max				
M 3	0,5	2,459	2,599	0030	●	2,479	2,619	0030	○		
M 3,5	0,6	2,850	3,010	0035	○	2,871	3,031	0035	○		
M 4	0,7	3,242	3,422	0040	●	3,264	3,444	0040	○		
M 4,5	0,75	3,688	3,878	0045	○	3,710	3,900	0045	○		
M 5	0,8	4,134	4,334	0050	○	4,158	4,358	0050	○		
M 6	1	4,917	5,153	0060	●	4,943	5,179	0060	○		
M 7	1	5,917	6,153	0070	○	5,943	6,179	0070	○		
M 8	1,25	6,647	6,912	0080	●	6,675	6,940	0080	○		
M 9	1,25	7,647	7,912	0090	○	7,675	7,940	0090	○		
M 10	1,5	8,376	8,676	0100	●	8,408	8,708	0100	○		
M 12	1,75	10,106	10,441	0120	●	10,140	10,475	0120	○		
M 14	2	11,835	12,210	0140	○	11,873	12,248	0140	○		
M 16	2	13,835	14,210	0160	●	13,873	14,248	0160	○		
M 18	2,5	15,294	15,744	0180	●	15,336	15,786	0180	○		
M 20	2,5	17,294	17,744	0200	○	17,336	17,786	0200	○		
M 22	2,5	19,294	19,744	0220	○	19,336	19,786	0220	○		
MF	P	Внутренний диаметр резьбы (6H)		INDEX	S3-100161	Внутренний диаметр резьбы(6G)		INDEX	S3-100162		
		min	max			min	max				
M 8 x 0,5	0,5	7,459	7,599	0081	○	7,479	7,619	0081	○		
M 8 x 0,75	0,75	7,188	7,378	0082	○	7,210	7,400	0082	○		
M 8 x 1	1	6,917	7,153	0083	●	6,943	7,179	0083	○		
M 9 x 1	1	7,917	8,153	0093	○	7,943	8,179	0093	○		
M 10 x 0,75	0,75	9,188	9,378	0102	○	9,210	9,400	0102	○		
M 10 x 1	1	8,917	9,153	0103	●	8,943	9,179	0103	○		
M 10 x 1,25	1,25	8,647	8,912	0104	○	8,675	8,940	0104	○		
M 11 x 1	1	9,917	10,153	0113	○	9,943	10,179	0113	○		
M 12 x 1	1	10,917	11,153	0123	○	10,943	11,179	0123	○		
M 12 x 1,25	1,25	10,647	10,912	0124	○	10,675	10,940	0124	○		
M 12 x 1,5	1,5	10,376	10,676	0125	●	10,408	10,708	0125	○		
M 13 x 1	1	11,917	12,153	0133	○	11,943	12,179	0133	○		
M 14 x 1	1	12,917	13,153	0143	○	12,943	13,179	0143	○		
M 14 x 1,25	1,25	12,647	12,912	0144	○	12,675	12,940	0144	○		
M 14 x 1,5	1,5	12,376	12,676	0145	●	12,408	12,708	0145	○		
M 15 x 1	1	13,917	14,153	0153	○	13,943	14,179	0153	○		
M 15 x 1,5	1,5	13,376	13,676	0155	○	13,408	13,708	0155	○		
M 16 x 1	1	14,917	15,153	0163	○	14,943	15,179	0163	○		
M 16 x 1,5	1,5	14,376	14,676	0165	●	14,408	14,708	0165	○		
M 18 x 1	1	16,917	17,153	0183	○	16,943	17,179	0183	○		
M 18 x 1,5	1,5	16,376	16,676	0185	○	16,408	16,708	0185	○		
M 18 x 2	2	15,835	16,210	0186	○	15,873	16,248	0186	○		
M 20 x 1	1	18,917	19,153	0203	○	18,943	19,179	0203	○		
M 20 x 1,5	1,5	18,376	18,676	0205	●	18,408	18,708	0205	○		
M 20 x 2	2	17,835	18,210	0206	○	17,873	18,248	0206	○		
M 22 x 1	1	20,917	21,153	0223	○	20,943	21,179	0223	○		
M 22 x 1,5	1,5	20,376	20,676	0225	○	20,408	20,708	0225	○		
M 22 x 2	2	19,835	20,210	0226	○	19,873	20,248	0226	○		

Проходные калибры для резьбы, больше чем 52, обозначаются MSCb, а не проходные - MSCc, и изготавливаются с отдельными ручками

Основная метрическая резьба ISO DIN-13



Комплект калибров на странице 210



LH

6G

Обозначение

MSBg

 MSBg
LH

MSBg

MSRh

MSRk

Тип

GO / NOGO

GO / NOGO

GO / NOGO

GO

NOGO

M	P	Точность INDEX	6H		6G	6g	
			S3-302161	S3-301161	S3-302162	Y3-412162	Y3-422162
M 1	0,25	0010	●	○	○	●	●
M 1,2	0,25	0012	●	○	○	●	●
M 1,4	0,3	0014	●	○	○	●	●
M 1,6	0,35	0016	●	○	○	●	●
M 1,7	0,35	0017	●	○	○	●	●
M 1,8	0,35	0018	●	○	○	●	●
M 2	0,4	0020	●	○	○	●	●
M 2,2	0,45	0022	●	○	○	●	●
M 2,5	0,45	0025	●	○	○	●	●
M 2,6	0,45	0026	●	○	○	●	●
M 3	0,5	0030	●	○	○	●	●
M 3,5	0,6	0035	●	○	○	●	●
M 4	0,7	0040	●	○	○	●	●
M 4,5	0,75	0045	●	○	○	●	●
M 5	0,8	0050	●	○	○	●	●
M 6	1	0060	●	○	○	●	●
M 7	1	0070	●	○	○	●	●
M 8	1,25	0080	●	○	○	●	●
M 9	1,25	0090	●	○	○	●	●
M 10	1,5	0100	●	○	○	●	●
M 12	1,75	0120	●	○	○	●	●
M 14	2	0140	●	○	○	●	●
M 16	2	0160	●	○	○	●	●
M 18	2,5	0180	●	○	○	●	●
M 20	2,5	0200	●	○	○	●	●
M 22	2,5	0220	●	○	○	●	●
M 24	3	0240	●	○	○	●	●
M 27	3	0270	●	○	○	●	●
M 30	3,5	0300	●	○	○	●	●
M 33	3,5	0330	●	○	○	●	●
M 36	4	0360	●	○	○	●	●
M 39	4	0390	●	○	○	●	●
M 42	4,5	0420	●	○	○	●	●
M 45	4,5	0450	●	○	○	●	●
M 48	5	0480	●	○	○	●	●
M 52	5	0520	●	○	○	●	●

Проходные калибры для резьбы, больше чем 52, обозначаются MSCb, а не проходные - MSCc, и изготавливаются с отдельными ручками

Мелкая метрическая резьба ISO DIN-13



Обозначение

MSBg

MSBg
LH

MSBg

MSRh

MSRk

Тип

GO / NOGO

GO / NOGO

GO / NOGO

GO

NOGO

MF	P	Точность INDEX	6H	6H	6G	6g	6g
			S3-302161	S3-301161	S3-302162	Y3-412162	Y3-422162
M 3 x 0,35	0,35	0031	○	○	○	○	○
M 3,5 x 0,35	0,35	0036	○	○	○	○	○
M 4 x 0,35	0,35	0043	○	○	○	○	○
M 4x0,5	0,5	0041	○	○	○	○	○
M 4,5 x 0,5	0,5	0046	○	○	○	○	○
M 5 x 0,5	0,5	0051	○	○	○	○	○
M 6 x 0,5	0,5	0061	○	○	○	○	○
M 6 x 0,75	0,75	0062	○	○	○	○	○
M 8 x 0,5	0,5	0081	○	○	○	○	○
M 8 x 0,75	0,75	0082	○	○	○	○	○
M 8 x 1	1	0083	●	●	○	●	●
M 9 x 1	1	0093	○	○	○	○	○
M 10 x 0,75	0,75	0102	○	○	○	○	○
M 10 x 1	1	0103	●	●	○	●	●
M 10 x 1,25	1,25	0104	●	●	○	●	●
M 11 x 1	1	0113	○	○	○	○	○
M 12 x 1	1	0123	●	●	○	●	●
M 12 x 1,25	1,25	0124	●	●	○	●	●
M 12 x 1,5	1,5	0125	●	●	○	●	●
M 13 x 1	1	0133	○	○	○	○	○
M 14 x 1	1	0143	○	○	○	○	○
M 14 x 1,25	1,25	0144	○	○	○	○	○
M 14 x 1,5	1,5	0145	●	●	○	●	●
M 15 x 1	1	0153	○	○	○	○	○
M 15 x 1,5	1,5	0155	○	○	○	○	○
M 16 x 1	1	0163	●	●	○	●	●
M 16 x 1,5	1,5	0165	●	●	○	●	●
M 18 x 1	1	0183	○	○	○	○	○
M 18 x 1,5	1,5	0185	●	●	○	●	●
M 18 x 2	2	0186	○	○	○	○	○
M 20 x 1	1	0203	●	●	○	●	●
M 20 x 1,5	1,5	0205	●	●	○	●	●
M 20 x 2	2	0206	○	○	○	○	○
M 22 x 1	1	0223	○	○	○	○	○
M 22 x 1,5	1,5	0225	●	●	○	●	●
M 22 x 2	2	0226	●	●	○	●	●
M 24 x 1	1	0243	○	○	○	○	○
M 24 x 1,5	1,5	0245	●	●	○	●	●
M 24 x 2	2	0246	●	○	○	○	○
M 25 x 1,5	1,5	0255	●	○	○	○	○
M 26 x 1,5	1,5	0265	●	○	○	○	○
M 27 x 1,5	1,5	0275	●	○	○	○	○

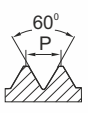
Мелкая метрическая резьба ISO DIN-13								
								
Обозначение				MSBg	MSBg LH	MSBg	MSRh	MSRk
Тип				GO / NOGO	GO / NOGO	GO / NOGO	GO	NOGO
MF	P	Точность		6H	6H	6G	6g	6g
		INDEX	S3-302161	S3-301161	S3-302162	Y3-412162	Y3-422162	
M 27 x 2	2	0276	●	○	○	○	○	○
M 28 x 1,5	1,5	0285	●	○	○	○	○	○
M 28 x 2	2	0286	○	○	○	○	○	○
M 30 x 1	1	0303	○	○	○	○	○	○
M 30 x 1,5	1,5	0305	●	○	○	○	○	○
M 30 x 2	2	0306	●	○	○	○	○	○
M 32 x 1,5	1,5	0325	●	○	○	○	○	○
M 33 x 1,5	1,5	0335	●	○	○	○	○	○
M 33 x 2	2	0336	●	○	○	○	○	○
M 33 x 3	3	0337	○	○	○	○	○	○
M 34 x 1,5	1,5	0345	○	○	○	○	○	○
M 35 x 1,5	1,5	0355	●	○	○	○	○	○
M 36 x 1,5	1,5	0365	●	○	○	○	○	○
M 36 x 2	2	0366	●	○	○	○	○	○
M 36 x 3	3	0367	○	○	○	○	○	○
M 38 x 1,5	1,5	0385	●	○	○	○	○	○
M 39 x 2	2	0396	●	○	○	○	○	○
M 39 x 3	3	0397	○	○	○	○	○	○
M 40 x 1,5	1,5	0405	●	○	○	○	○	○
M 40 x 2	2	0406	○	○	○	○	○	○
M 40 x 3	3	0407	○	○	○	○	○	○
M 42 x 1,5	1,5	0425	●	○	○	○	○	○
M 42 x 2	2	0426	●	○	○	○	○	○
M 42 x 3	3	0427	●	○	○	○	○	○
M 45 x 1,5	1,5	0455	●	○	○	○	○	○
M 45 x 2	2	0456	●	○	○	○	○	○
M 45 x 3	3	0457	○	○	○	○	○	○
M 48 x 1,5	1,5	0485	●	○	○	○	○	○
M 48 x 2	2	0486	●	○	○	○	○	○
M 48 x 3	3	0487	●	○	○	○	○	○
M 50 x 1,5	1,5	0505	○	○	○	○	○	○
M 50 x 2	2	0506	○	○	○	○	○	○
M 50 x 3	3	0507	○	○	○	○	○	○
M 52 x 1,5	1,5	0525	●	○	○	○	○	○
M 52 x 2	2	0526	●	○	○	○	○	○
M 52 x 3	3	0527	●	○	○	○	○	○

Проходные калибры для резьбы, больше чем 52, обозначаются MSCb, а не проходные - MSCc, и изготавливаются с отдельными ручками



Американская унифицированная резьба
UNC, ANSI B-1.1



Размеры калибра согласно норме ANSI/ASME B1.2



Обозначение

MSBg

MSBg

MSRh

MSRk

Тип

GO / NOGO



GO / NOGO

GO

NOGO

UNC	d _i	1"/P	Точность		2B	3B	2A	2A
			INDEX					
No 5 - 40	3,175	40	4105	●	○	○	○	
No 6 - 32	3,505	32	4106	●	○	○	○	
No 8 - 32	4,166	32	4108	●	○	○	○	
No 10 - 24	4,826	24	4110	●	○	○	○	
No 12 - 24	5,486	24	4112	●	○	○	○	
1/4 - 20	6,350	20	4127	●	○	○	○	
5/16 - 18	7,938	18	4128	●	○	○	○	
3/8 - 16	9,525	16	4129	●	○	○	○	
7/16 - 14	11,112	14	4130	●	○	○	○	
1/2 - 13	12,700	13	4131	●	○	○	○	
9/16 - 12	14,288	12	4132	●	○	○	○	
5/8 - 11	15,875	11	4133	●	○	○	○	
3/4 - 10	19,050	10	4135	●	○	○	○	
7/8 - 9	22,225	9	4137	●	○	○	○	
1 - 8	25,400	8	4139	●	○	○	○	
1.1/8 - 7	28,575	7	4141	○	○	○	○	
1.1/4 - 7	31,750	7	4143	○	○	○	○	
1.3/8 - 6	34,925	6	4145	○	○	○	○	
1.1/2 - 6	38,100	6	4147	○	○	○	○	
1.3/4 - 5	44,450	5	4151	○	○	○	○	
2 - 4.1/2	50,800	4.1/2	4155	○	○	○	○	

7

Американская унифицированная резьба UNF, ANSI B-1.2							
 Размеры калибра согласно норме ANSI/ASME B1.2							
Обозначение				GO / NOGO	GO / NOGO	GO	NOGO
Тип				2B	3B	2A	2A
UNF	d ₁	1"/P	Точность INDEX	S3-302186	S3-302187	Y3-412182	Y3-422182
No 5 - 44	3,175	44	4205	○	○	○	○
No 6 - 40	3,505	40	4206	○	○	○	○
No 8 - 36	4,166	36	4208	○	○	○	○
No 10 - 32	4,826	32	4210	○	○	○	○
No 12 - 28	5,486	28	4212	○	○	○	○
1/4 - 28	6,350	28	4227	●	○	○	○
5/16 - 24	7,938	24	4228	●	○	○	○
3/8 - 24	9,525	24	4229	●	○	○	○
7/16 - 20	11,112	20	4230	●	○	○	○
1/2 - 20	12,700	20	4231	●	○	○	○
9/16 - 18	14,288	18	4232	●	○	○	○
5/8 - 18	15,875	18	4233	●	○	○	○
3/4 - 16	19,050	16	4235	●	○	○	○
7/8 - 14	22,225	14	4237	●	○	○	○
1 - 12	25,400	12	4239	●	○	○	○
1.1/8 - 12	28,575	12	4241	○	○	○	○
1.1/4 - 12	31,750	12	4243	○	○	○	○
1.3/8 - 12	34,925	12	4245	○	○	○	○
1.1/2 - 12	38,100	12	4247	○	○	○	○

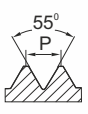
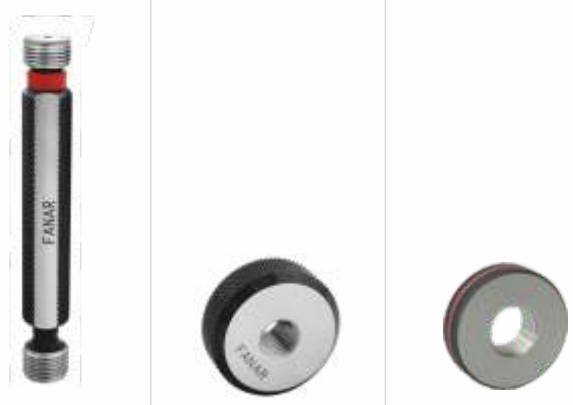
Трубная резьба G, DIN-ISO 228						
						
Размеры калибра согласно норме ISO 228-2						
Обозначение				MSBg	MSRh	MSRk
Тип				GO / NOGO	GO	NOGO
G	d _i	1"/P	Точность	A		
			INDEX	Y3-412180	Y3-422180	
G-1/8"	9,73	28	3123	●	○	
G-1/4"	13,16	19	3127	●	○	
G-3/8"	16,66	19	3129	●	●	
G-1/2"	20,96	14	3131	●	●	
G-5/8"	22,91	14	3133	○	○	
G-3/4"	26,44	14	3135	●	●	
G-7/8"	30,20	14	3137	○	○	
G-1"	33,25	11	3139	●	●	
G-1.1/8"	37,90	11	3141	●	○	
G-1.1/4"	41,91	11	3143	●	○	

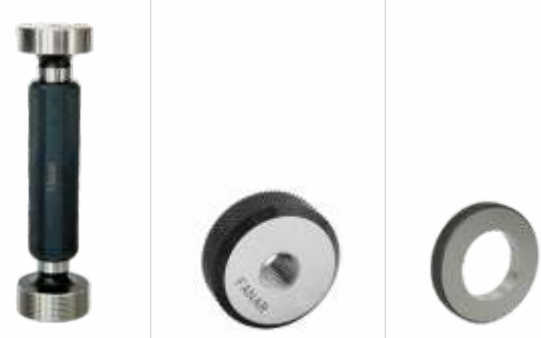
Трубная резьба Pg, DIN-40430						
						
Обозначение				MSBg	MSRh	MSRc
Тип				GO / NOGO	GO	NOGO
Pg	d _i	1"/P	Точность			
			INDEX	S3-832100	Y3-412100	Y3-450100
Pg 7	12,5	20	8807	○	○	○
Pg 9	15,2	18	8809	○	○	○
Pg 11	18,6	18	8811	○	○	○
Pg 13,5	20,4	18	8813	○	○	○
Pg 16	22,5	18	8816	○	○	○
Pg 21	28,3	16	8821	○	○	○
Pg 29	37	16	8829	○	○	○
Pg 36	47	16	8836	○	○	○

Резьба Pg заменена на мелкую метрическую резьбу согласно DIN EN 60423 и изготавливается по предварительному заказу



Трубная резьба без дальнейшего использования в ней уплотнительных материалов

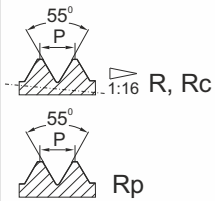

PN-EN 10226-1,
PN-EN 10226-2 (ISO7-1:2000)

Размеры калибра согласно норме
PN-EN 10226-3

PN-EN 10226-3 (ISO7-2:2000)



Обозначение

MSXa MSXa MSXc MSXc MSXa

Тип

Nr 1 Nr 2 Nr 3 Nr 4 Nr 5

Rc/Rp	d ₁	1"/P	Точность	Rc/Rp	Rc/Rp	R	R	R
			INDEX	S3-332101	S3-332102	-	-	S3-332105
1/16"	7,72	28	3321	o	o			o
1/8"	9,73	28	3323	o	o			o
1/4"	13,16	19	3327	o	o			o
3/8"	16,66	19	3329	o	o			o
1/2"	20,96	14	3331	o	o			o
3/4"	26,44	14	3335	o	o			o
1"	32,25	11	3339	o	o			o
1.1/4"	41,91	11	3343	o	o			o
1.1/2"	47,80	11	3347	o	o			o
2"	59,61	11	3355	o	o			o
2.1/2"	75,18	11	3359	o	o			o
3"	87,88	11	3363	o	o			o
4"	113,03	11	3371	o	o			o
R	d ₁	1"/P	INDEX	-	-	Y3-432103	Y3-432104	-
1/16"	7,72	28	3421			o	o	
1/8"	9,73	28	3423			o	o	
1/4"	13,16	19	3427			o	o	
3/8"	16,66	19	3429			o	o	
1/2"	20,96	14	3431			o	o	
3/4"	26,44	14	3435			o	o	
1"	32,25	11	3439			o	o	
1.1/4"	41,91	11	3443			o	o	
1.1/2"	47,80	11	3447			o	o	
2"	59,61	11	3455			o	o	
2.1/2"	75,18	11	3459			o	o	
3"	87,88	11	3463			o	o	
4"	113,03	11	3471			o	o	

Техническая информация относительно использования калибров для резьбы стандарта R и Rc/Rp в тех. части на стр. 250



**Резьба Витворта, основной (крупный) шаг
BSW, BS-84:1956**

Размеры калибра согласно норме BS 919-2



Обозначение

MSBg

MSRh

MSRk

Тип

GO / NOGO

GO

NOGO

BSW	d _r	1"/P	Точность	medium	medium	medium
			INDEX	S3-302100	Y3-412100	Y3-422100
1/8 - 40	3,175	40	7123	○	○	○
3/16 - 24	4,762	24	7125	○	○	○
1/4 - 20	6,350	20	7127	○	○	○
5/16 - 18	7,938	18	7128	○	○	○
3/8 - 16	9,525	16	7129	○	○	○
7/16 - 14	11,112	14	7130	○	○	○
1/2 - 12	12,700	12	7131	○	○	○
9/16 - 12	14,288	12	7132	○	○	○
5/8 - 11	15,875	11	7133	○	○	○
3/4 - 10	19,050	10	7135	○	○	○
7/8 - 9	22,225	9	7137	○	○	○
1 - 8	25,400	8	7139	○	○	○
1.1/8 - 7	28,575	7	7141	○	○	○
1.1/4 - 7	31,750	7	7143	○	○	○
1.3/8 - 6	34,925	6	7145	○	○	○
1.1/2 - 6	38,100	6	7147	○	○	○
1.3/4 - 5	44,450	5	7151	○	○	○
2 - 4.1/2	50,800	4.1/2	7155	○	○	○

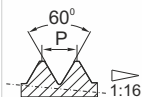
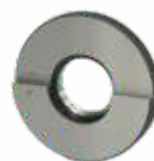

**Американская коническая трубная резьба
NPT 1:16, ANSI B-1.20.1**

Размеры калибра согласно норме ANSI/ASME B1.20.1

Обозначение

MSXa



MSXc

Тип

NPT d ₁	1"/P	Точность		S3-332100	Y3-432100
		INDEX			
1/16"	27	4621	○	○	
1/8"	27	4623	○	○	
1/4"	18	4627	○	○	
3/8"	18	4629	●	○	
1/2"	14	4631	●	○	
3/4"	14	4635	●	○	
1"	11.1/2	4639	●	○	
1.1/4"	11.1/2	4643	○	○	
1.1/2"	11.1/2	4647	○	○	
2"	11.1/2	4655	○	○	

Техническая информация относительно использования калибров для резьбы стандарта NPT в тех. части стр. 295

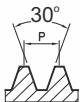

Трапецевидная резьба Tr, DIN-103						
						
Размеры калибра согласно норме DIN 103-9						
Обозначение				MSBg	MSRh	MSRk
Тип				GO / NOGO	GO	NOGO
Tr d, [mm]	P [mm]	Точность		7H	7e	7e
		INDEX		S3-302171	Y3-412174	Y3-422174
Tr 10 x 2	2	8009		○	○	○
Tr 12 x 3	3	8015		○	○	○
Tr 14 x 3	3	8019		○	○	○
Tr 16 x 4	4	8024		○	○	○
Tr 18 x 4	4	8032		○	○	○
Tr 20 x 4	4	8034		○	○	○
Tr 22 x 5	5	8037		○	○	○
Tr 24 x 5	5	8042		○	○	○
Tr 26 x 5	5	8047		○	○	○
Tr 28 x 5	5	8052		○	○	○
Tr 30 x 6	6	8057		○	○	○
Tr 32 x 6	6	8062		○	○	○
Tr 36 x 6	6	8072		○	○	○

Держатели инструмента

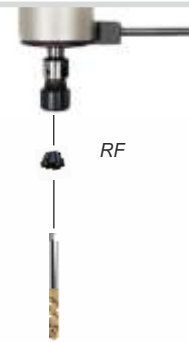
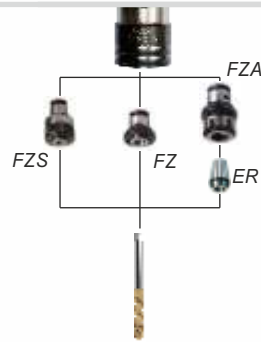
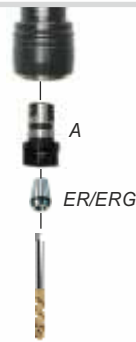
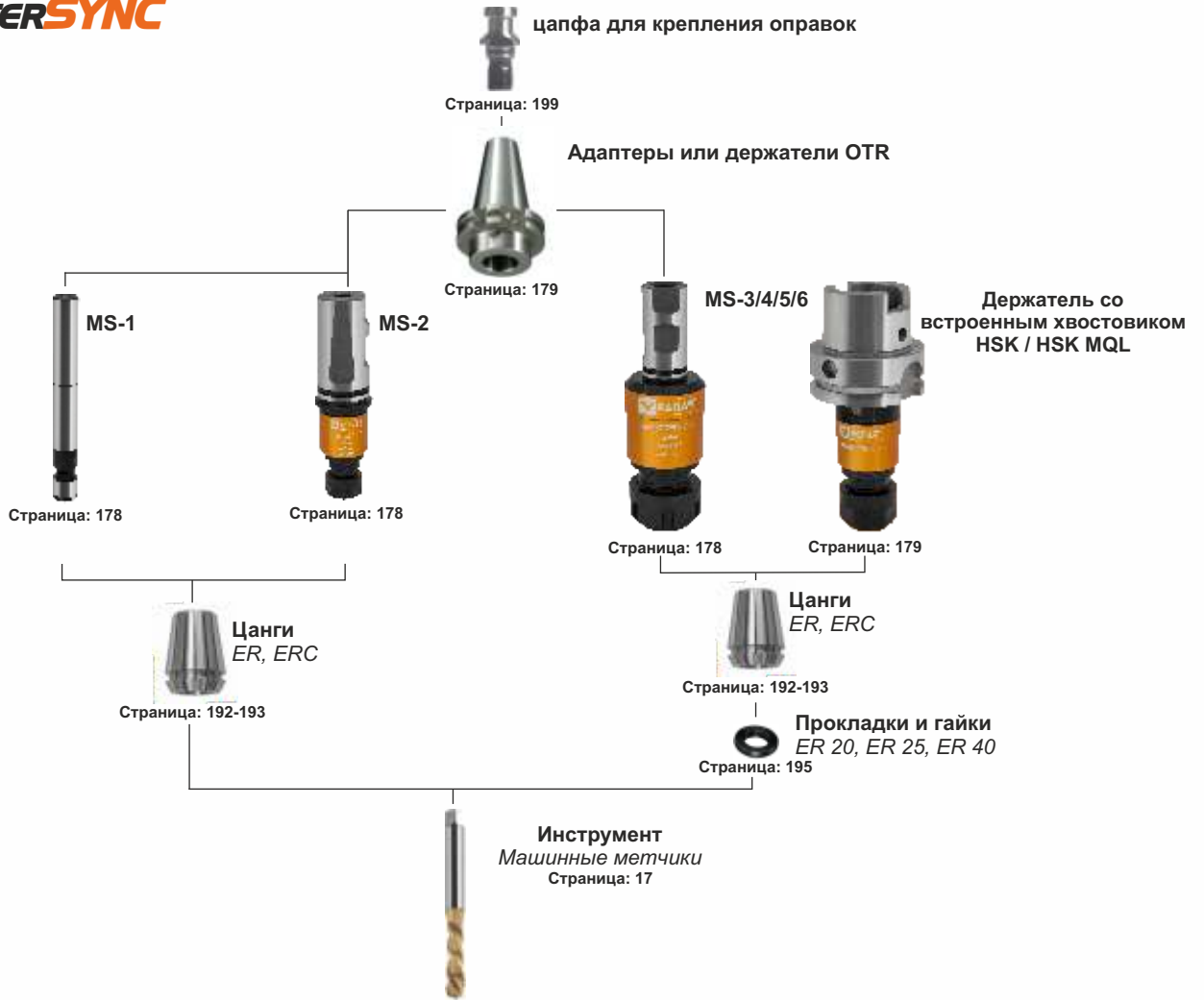

MS	Держатели метчиков с функцией "SOFT SYNCHRO"	MASTERSYNC	178-179
OGSS	Держатели метчиков с функцией „SOFT SYNCHRO“		180-182
OGK	Быстросменные держатели метчиков с осевой компенсацией		183-186
OGN	Держатели с функцией реверса		187
FZS	Быстросменные адаптеры с предохранительной муфтой		188
FZ	Быстросменные адаптеры БЕЗ предохранительной муфты		189
FZA	Цанговые адапте для метчиков, с использованием цанг стандарта ER		190
A	Адаптеры для метчиков, с использованием цанг стандарта er		191
ER	Цанговые оправки, для крепления осевого инструмента		192
ERC	Оправки для крепления инструмента за присоединительный квадрат		193
ERG	цанговые оправки с резиновым уплотнением		194
ERCG	Цанги с резиновой прокладкой и с квадратным профилем зажима для метчиков		194
R	Прокладки и гайки		195
TR	Регулируемые втулки для держателей типа OGS		196
TRH	Редукционные цанги TRH		197
RF	Гибкие резиновые оправки для держателей типа OGN		198
C	Цапфы для крепления оправок		199-200

MASTERSYNC

Страница	180-182	183-186	187
Описание	Для нарезания резьбы "Soft Synchro" с минимальной осевой компенсацией 1mm на растяжение и 0,2mm на сжатие.	Для нарезания резьбы с осевой компенсацией и компенсацией на растяжение	Для нарезания резьбы с осевой компенсацией и компенсацией на растяжение и реверсивным движением, для станков с правосторонним вращением шпинделя.

Хвостовик	Стандарт	Обозначение	OGSS	OGK	OGN
MORSE'A	DIN-228 A/B	MK		MK2, MK3, MK4, MK5	MK1, MK2, MK3, MK4 (JT6, M20)
DIN	DIN-2080	DIN		DIN30, DIN40, DIN50	
TR	DIN-6327	TR		TR20, TR28, TR36, TR48	
ISO	DIN 69871 A	ISO	ISO40, ISO50	ISO30, ISO40, ISO50	
MAS-BT	JIS B 6339	BT	BT40, BT50	BT30, BT40, BT50	
HSK	DIN 69893 A	HSK	HSK40, HSK50, HSK63, HSK100	HSK50, HSK63, HSK80, HSK100	
VDI	DIN 69880	VDI	VDI30, VDI40	VDI20, VDI25, VDI30, VDI40, VDI50	
WELDON	DIN 1835 B	W	W25, W40	W20, W25, W32, W40	
POLYGONAL	ISO 26623-1	C	C40, C50, C63, C80	C40, C50, C63, C80	

• осевая компенсация : +/- 0,5

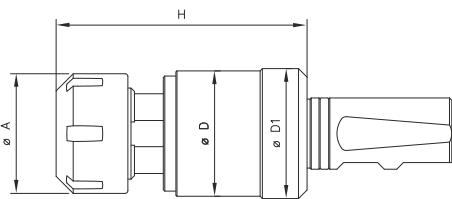

Аксессуары

Прокладки
и гайки 195
MASTERSYNC

MS-1 MS-2 MS-3 MS-4 MS-5 MS-6



Область применения

M1+M3 M2+M5 M4,5+M12 M8+M20 M16+M30 M22+M48

Внутреннее охлаждение

- - IK IK IK IK

Модель	Хвостовик	Цанги	M	D	D ₁	A	H	Прокладки и гайки	INDEX
MS-1-D12	12	ER8	M1+M3	12	12	12	28	-	R-MS-1-D12
MS-2-W25	25	ER11	M2+M5	23,5	23,5	19	52	-	R-MS-2-W25
MS-3-W25	25	ER20	M4,5+M12	34,6	36,3	34	69	+	R-MS-3-W25
MS-4-W25	25	ER25	M8+M20	44	45,6	42	88	+	R-MS-4-W25
MS-5-W25	25	ER40	M16+M30	62	63,6	63	117	+	R-MS-5-W25
MS-6-W40	40	ER50	M22+M48	80	87	78	166	+	R-MS-6-W40

• осевая компенсация : +/- 0,5

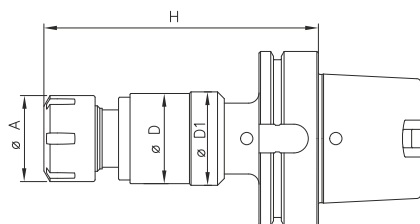

Аксессуары

Прокладки
и гайки 195
MASTERSYNC

MS-3

MS-4

MS-5



Область применения

M4+M12 M8+M20 M16+M30

Внутреннее охлаждение

IK IK IK

Модель	Хвостовик	Цанги	M	D	D ₁	A	H	Прокладки и гайки	INDEX
MS-3-HSK63A	HSK63A	ER20	M4+M12	34,6	36,3	34	108	+	R-MS-3-HSK63A
MS-3-HSK80A	HSK80A	ER20	M4+M12	34,6	36,3	34	113	+	R-MS-3-HSK80A
MS-3-HSK100A	HSK100A	ER20	M4+M12	34,6	36,3	34	115	+	R-MS-3-HSK100A
MS-4-HSK63A	HSK63A	ER25	M8+M20	44	45,6	42	128	+	R-MS-4-HSK63A
MS-4-HSK80A	HSK80A	ER25	M8+M20	44	45,6	42	115	+	R-MS-4-HSK80A
MS-4-HSK100A	HSK100A	ER25	M8+M20	44	45,6	42	131	+	R-MS-4-HSK100A
MS-5-HSK63A	HSK63A	ER40	M16+M30	62	63,6	63	160	+	R-MS-5-HSK63A
MS-5-HSK80A	HSK80A	ER40	M16+M30	62	63,6	63	161	+	R-MS-5-HSK80A
MS-5-HSK100A	HSK100A	ER40	M16+M30	62	63,6	63	163	+	R-MS-5-HSK100A

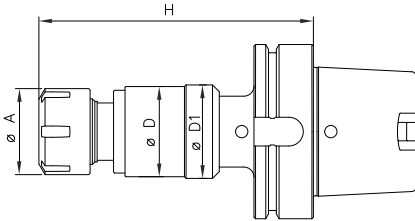

- Особенности и преимущества:**
- продлевает срок службы метчика на 100% и более
 - повышает качество резьбы
 - точная подачи смазки продлевает срок службы инструмента
 - уменьшает затраты на хладагент в процессе эксплуатации
 - использование меньшего количества хладагента делает весь процесс более экологически чистым
 - в стандартной версии одноканальная система охлаждения
 - осевая компенсация: +/- 0,5”

MASTERSYNC
MS-3
MS-4

Область применения

M4+M12

M8+M20

Внутреннее охлаждение

MQL

MQL

Модель	Хвостовик	Цанги	M	D	D ₁	A	H	Прокладки и гайки	INDEX
MS-3-HSK63A-MQL	HSK63A	ER20	M4+M12	34,6	36,6	34	108	+	R-MS-3-HSK63A-MQL
MS-3-HSK80A-MQL	HSK80A	ER20	M4+M12	34,6	36,6	34	113	+	R-MS-3-HSK80A-MQL
MS-3-HSK100A-MQL	HSK100A	ER20	M4+M12	34,6	36,6	34	115	+	R-MS-3-HSK100A-MQL
MS-4-HSK63A-MQL	HSK63A	ER25	M8+M20	44	44	42	128	+	R-MS-4-HSK63A-MQL
MS-4-HSK80A-MQL	HSK80A	ER25	M8+M20	44	44	42	131	+	R-MS-4-HSK80A-MQL
MS-4-HSK100A-MQL	HSK100A	ER25	M8+M20	44	44	42	133	+	R-MS-4-HSK100A-MQL

Адаптеры

OTR

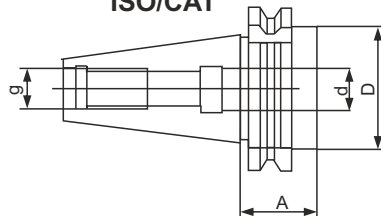
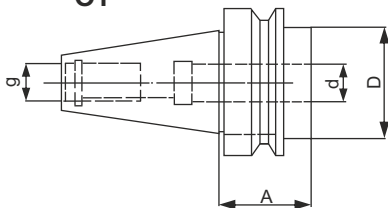
ISO/CAT

OT

Область применения

Внутреннее охлаждение

Модель	Хвостовик	D	d	A	g	нормы и стандарты	INDEX
ISO40	ISO40	45	25	35	M16	DIN-69871	R-OTR-ISO40/D25
ISO40	ISO40	90	40	120	M16	DIN-69871	R-OTR-ISO40/D25
ISO50	ISO50	72	25	35	M24	DIN-69871	R-OTR-ISO50/D25
ISO50	ISO50	90	40	100	M24	DIN-69871	R-OTR-ISO50/D25
CAT40	CAT40	45	25	35	5/8"-11	CAT	R-OTR-CAT40/D25
CAT50	CAT50	70	25	35	1"-8	CAT	R-OTR-CAT50/D25
CAT50	CAT50	70	40	75	1"-8	CAT	R-OTR-CAT50/D25
BT40	BT40	45	25	35	M16	DIN-B6339	R-OTR-BT40/D25
BT50	BT50	70	25	48	M24	DIN-B6339	R-OTR-BT50/D25
BT50	BT50	90	40	110	M24	DIN-B6339	R-OTR-BT50/D25

Информация:

- Для станков с синхронизированной функцией «rigid tapping»
- Маленькая осевая компенсация: 0,2мм на сжатие, 1мм на растяжение
- Максимально допустимое давление СОЖ - 50bar
- Для державок с внутренним охлаждением - использовать цапфы с центральным отверстием IK

Аксессуары



Стандарт

DIN-69871

JIS B6339

Внутреннее охлаждение



Хвостовик	Адаптер	D	A	H	M	INDEX		INDEX	
ISO40	A20	20	43	53	M3-M12	R-OGSS-ISO40/A20	●		
ISO40	A32	32	60	90	M6-M20	R-OGSS-ISO40/A32	●		
ISO50	A20	20	43	53	M3-M12	R-OGSS-ISO50/A20	○		
ISO50	A32	32	60	74	M6-M20	R-OGSS-ISO50/A32	○		
ISO50	A50	50	87	115	M14-M33	R-OGSS-ISO50/A50	○		
BT40	A20	20	43	61	M3-M12			R-OGSS-BT40/A20	○
BT40	A32	32	60	80	M6-M20			R-OGSS-BT40/A32	○
BT50	A20	20	43	72	M3-M12			R-OGSS-BT50/A20	○
BT50	A32	32	60	93	M6-M20			R-OGSS-BT50/A32	○
BT50	A50	50	87	124	M14-M33			R-OGSS-BT50/A50	○

Держатели с охлаждением через фланец AD+B с хвостовиками ISO 45, DIN 40, DIN 50 - под заказ

Информация: <ul style="list-style-type: none"> Для станков с синхронизированной функцией «rigid tapping» Маленькая осевая компенсация: 0,2мм на сжатие, 1мм на растяжение Максимально допустимое давление СОЖ - 50bar 						HSK		VDI	
Аксессуары						Адаптеры 191 Цанги 192			
А						ER			
Стандарт						DIN-69893 A		DIN-69880	
Внутреннее охлаждение									
Хвостовик	Адаптер	D	A	H	M	INDEX		INDEX	
HSK40	A20	20	43	68	M3-M12	R-OGSS-HSK40/A20	○		
HSK40	A32	32	59	89	M6-M20	R-OGSS-HSK40/A32	○		
HSK50	A20	20	43	70	M3-M12	R-OGSS-HSK50/A20	○		
HSK50	A32	32	59	76	M6-M20	R-OGSS-HSK50/A32	○		
HSK63	A20	20	43	63	M3-M12	R-OGSS-HSK63/A20	○		
HSK63	A32	32	59	59	M6-M20	R-OGSS-HSK63/A32	○		
HSK63	A50	50	87	122	M3-M12	R-OGSS-HSK-63/A50	○		
HSK100	A20	20	43	70	M14-M33	R-OGSS-HSK100/A20	○		
HSK100	A32	32	59	91	M6-M20	R-OGSS-HSK100/A32	○		
HSK100	A50	50	87	115	M14-M33	R-OGSS-HSK100/A50	○		
VDI30	A20	20	43	45	M3-M12			R-OGSS-VDI30/A20	○
VDI30	A32	32	59	70	M6-M20			R-OGSS-VDI30/A32	○
VDI40	A20	20	43	45	M3-M12			R-OGSS-VDI40/A20	○
VDI40	A32	32	59	70	M6-M20			R-OGSS-VDI40/A32	○



Информация:

- Для станков с синхронизированной функцией «rigid tapping»
- Маленькая осевая компенсация: 0,2мм на сжатие, 1мм на растяжение
- Максимально допустимое давление СОЖ - 50bar

Аксессуары



POLYGONAL



WELDON

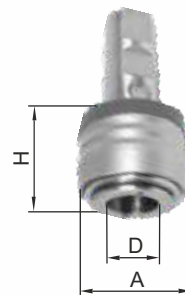

Стандарт

ISO 26623-1

DIN 1835 B+E

Внутреннее охлаждение



Хвостовик	Адаптер	D	A	H	M	INDEX		INDEX	
C40	A20	20	43	55	M3-M12	R-OGSS-C40/A20	○		
C40	A32	32	60	75	M6-M20	R-OGSS-C40/A32	○		
C50	A20	20	43	55	M3-M12	R-OGSS-C50/A20	○		
C50	A32	32	60	75	M6-M20	R-OGSS-C50/A32	○		
C63	A20	20	43	58	M3-M12	R-OGSS-C63/A20	○		
C63	A32	32	60	78	M6-M20	R-OGSS-C63/A32	○		
C63	A50	50	87	102	M14-M33	R-OGSS-C63/A50	○		
C80	A20	20	43	66	M3-M12	R-OGSS-C80/A20	○		
C80	A32	32	60	86	M6-M20	R-OGSS-C80/A32	○		
C80	A50	50	87	116	M14-M33	R-OGSS-C80/A50	○		
W25	A20	20	43	34	M3-M12			R-OGSS-W25/A20	○
W25	A32	32	60	56	M6-M20			R-OGSS-W25/A32	○
W40	A50	50	87	87	M14-M33			R-OGSS-W40/A50	○

									МК		МК-A										
Аксессуары <table border="1" style="width: 100%; text-align: center;"> <tr> <td>Адаптеры 188</td> <td>Адаптеры 191</td> <td>Цанг 192</td> </tr> <tr> <td></td> <td></td> <td></td> </tr> <tr> <td>FZS</td> <td>FZA</td> <td>ER</td> </tr> </table>									Адаптеры 188	Адаптеры 191	Цанг 192				FZS	FZA	ER				
Адаптеры 188	Адаптеры 191	Цанг 192																			
FZS	FZA	ER																			
Стандарт									MORSE DIN-228 B		MORSE DIN-228 A										
Внутреннее охлаждение																					
Хвостовик	Адаптер	D	A	H	M	↕		INDEX		INDEX											
						(-)	(+)														
MK2	FZ19	19	38	46	M2-M12	9	9	R-OGK-MK2/FZ19	●												
MK3	FZ19	19	38	46	M2-M12	9	9	R-OGK-MK3/FZ19	●												
MK3	FZ31	31	55	69	M6-M20	15	15	R-OGK-MK3/FZ31	●												
MK4	FZ48	48	79	108	M14-M33	24	24	R-OGK-MK4/FZ48	●												
MK5	FZ60	60	98	116	M22-M48	26	26	R-OGK-MK5/FZ60	●												
MK2	FZ19	19	38	46	M2-M12	9	9			R-OGK-MK2/FZ19-A	○										
MK3	FZ19	19	38	46	M2-M12	9	9			R-OGK-MK3/FZ19-A	○										
MK3	FZ31	31	55	69	M6-M20	15	15			R-OGK-MK3/FZ31-A	○										
MK4	FZ48	48	79	108	M14-M33	24	24			R-OGK-MK4/FZ48-A	○										
MK5	FZ60	60	98	116	M22-M48	26	26			R-OGK-MK5/FZ60-A	○										
									DIN		TR										
Аксессуары <table border="1" style="width: 100%; text-align: center;"> <tr> <td>Адаптеры 188</td> <td>Адаптеры 191</td> <td>Цанг 192</td> </tr> <tr> <td></td> <td></td> <td></td> </tr> <tr> <td>FZS</td> <td>FZA</td> <td>ER</td> </tr> </table>									Адаптеры 188	Адаптеры 191	Цанг 192				FZS	FZA	ER				
Адаптеры 188	Адаптеры 191	Цанг 192																			
FZS	FZA	ER																			
Стандарт									DIN-2080		DIN-6327										
Внутреннее охлаждение																					
Хвостовик	Адаптер	D	A	H	M	↕		INDEX		INDEX											
						(-)	(+)														
DIN30	FZ19	19	38	51	M2-M12	9	9	R-OGK-DIN30/FZ19	○												
DIN30	FZ31	31	55	86	M6-M20	15	15	R-OGK-DIN30/FZ31	○												
DIN40	FZ19	19	38	53	M2-M12	9	9	R-OGK-DIN40/FZ19	○												
DIN40	FZ31	31	55	77	M6-M20	15	15	R-OGK-DIN40/FZ31	○												
DIN40	FZ48	48	79	118	M14-M33	24	24	R-OGK-DIN40/FZ48	○												
DIN50	FZ19	19	38	57	M2-M12	9	9	R-OGK-DIN50/FZ19	○												
DIN50	FZ31	31	55	79	M6-M20	15	15	R-OGK-DIN50/FZ31	○												
DIN50	FZ48	48	79	125	M14-M33	24	24	R-OGK-DIN50/FZ48	○												
DIN50	FZ60	60	98	143	M22-M48	26	26	R-OGK-DIN50/FZ60	○												
TR20	FZ19	19	38	53	M2-M12	9	9			R-OGK-TR20/FZ19	○										
TR28	FZ19	19	38	53	M2-M12	9	9			R-OGK-TR28/FZ19	○										
TR28	FZ31	31	55	76	M6-M20	15	15			R-OGK-TR28/FZ31	○										
TR36	FZ19	19	38	55	M2-M12	9	9			R-OGK-TR36/FZ19	○										
TR36	FZ31	31	55	78	M6-M20	15	15			R-OGK-TR36/FZ31	○										
TR36	FZ48	48	79	111	M14-M33	24	24			R-OGK-TR36/FZ48	○										
TR36	FZ60	60	98	123	M22-M48	26	26			R-OGK-TR36/FZ60	○										
TR48	FZ48	48	79	115	M14-M33	24	24			R-OGK-TR48/FZ48	○										
TR48	FZ60	60	98	127	M22-M48	26	26			R-OGK-TR48/FZ60	○										



								ISO	MAS BT		
<p>Аксессуары</p> <div style="display: flex; justify-content: space-around;"> <div style="text-align: center;"> <p>Адаптеры 188</p> <p>FZS</p> </div> <div style="text-align: center;"> <p>Адаптеры 190</p> <p>FZA</p> </div> <div style="text-align: center;"> <p>Цанги 192</p> <p>ER</p> </div> <div style="text-align: center;"> <p>Цапфы для крепления оправок 199-200</p> <p>C</p> </div> </div>											
Стандарт								DIN-69871 A		JIS B6339	
Внутреннее охлаждение											
Хвостовик	Адаптер	D	A	H	M	↔		INDEX		INDEX	
						(-)	(+)				
ISO30	FZ19	19	38	60	M2-M12	9	9	R-OGK-ISO30/FZ19	○		
ISO30	FZ31	31	55	101	M6-M20	15	15	R-OGK-ISO30/FZ31	○		
ISO40	FZ19	19	38	60	M2-M12	9	9	R-OGK-ISO40/FZ19	●		
ISO40	FZ31	31	55	100	M6-M20	15	15	R-OGK-ISO40/FZ31	●		
ISO40	FZ48	48	79	138	M14-M33	24	24	R-OGK-ISO40/FZ48	○		
ISO40	FZ60	60	98	154	M22-M48	26	26	R-OGK-ISO40/FZ60	○		
ISO50	FZ19	19	38	62	M2-M12	9	9	R-OGK-ISO50/FZ19	○		
ISO50	FZ31	31	55	83	M6-M20	15	15	R-OGK-ISO50/FZ31	●		
ISO50	FZ48	48	79	133	M14-M33	24	24	R-OGK-ISO50/FZ48	●		
ISO50	FZ60	60	98	147	M22-M48	26	26	R-OGK-ISO50/FZ60	●		
BT30	FZ19	19	38	63	M2-M12	9	9			R-OGK-BT30/FZ19	○
BT30	FZ31	31	55	96	M6-M20	15	15			R-OGK-BT30/FZ31	○
BT40	FZ19	19	38	68	M2-M12	9	9			R-OGK-BT40/FZ19	●
BT40	FZ31	31	55	93	M6-M20	15	15			R-OGK-BT40/FZ31	●
BT40	FZ48	48	79	138	M14-M33	24	24			R-OGK-BT40/FZ48	○
BT40	FZ60	60	98	157	M22-M48	26	26			R-OGK-BT40/FZ60	○
BT50	FZ19	19	38	80	M2-M12	9	9			R-OGK-BT50/FZ19	○
BT50	FZ31	31	55	102	M6-M20	15	15			R-OGK-BT50/FZ31	●
BT50	FZ48	48	79	133	M14-M33	24	24			R-OGK-BT50/FZ48	○
BT50	FZ60	60	98	147	M22-M48	26	26			R-OGK-BT50/FZ60	○

Тип OGK с системой внутреннего подвода СОЖ по запросу

								HSK	VDI		
Аксессуары											
		Адаптеры 188		Адаптеры 191		Цанги 192					
		FZS		FZA		ER					
Стандарт								DIN-69893 A	DIN-69880		
Внутреннее охлаждение											
Хвостовик	Адаптер	D	A	H	M	↕		INDEX		INDEX	
						(-)	(+)				
HSK50	FZ19	19	41	72	M2-M12	7,5	7,5	R-OGK-HSK50/FZ19	○		
HSK50	FZ31	31	60	110	M6-M20	10	10	R-OGK-HSK50/FZ31	○		
HSK63	FZ19	19	41	72	M2-M12	7,5	7,5	R-OGK-HSK63/FZ19	●		
HSK63	FZ31	31	60	110	M6-M20	10	10	R-OGK-HSK63/FZ31	●		
HSK63	FZ48	48	86	141	M14-M33	17,5	17,5	R-OGK-HSK63/FZ48	○		
HSK80	FZ19	19	41	75	M2-M12	7,5	7,5	R-OGK-HSK80/FZ19	○		
HSK80	FZ31	31	60	95	M6-M20	10	10	R-OGK-HSK80/FZ31	○		
HSK80	FZ48	48	86	141	M14-M33	17,5	17,5	R-OGK-HSK80/FZ48	○		
HSK100	FZ19	19	41	80	M2-M12	7,5	7,5	R-OGK-HSK100/FZ19	○		
HSK100	FZ31	31	60	100	M6-M20	10	10	R-OGK-HSK100/FZ31	○		
HSK100	FZ48	48	86	141	M14-M33	17,5	17,5	R-OGK-HSK100/FZ48	○		
VDI20	FZ19	19	38	55	M2-M12	9	9			R-OGK-VDI20/FZ19	○
VDI20	FZ31	31	55	77	M6-M20	15	15			R-OGK-VDI20/FZ31	○
VDI25	FZ19	19	38	55	M2-M12	9	9			R-OGK-VDI25/FZ19	●
VDI25	FZ31	31	55	77	M6-M20	15	15			R-OGK-VDI25/FZ31	●
VDI30	FZ19	19	38	55	M2-M12	9	9			R-OGK-VDI30/FZ19	●
VDI30	FZ31	31	55	77	M6-M20	15	15			R-OGK-VDI30/FZ31	●
VDI40	FZ19	19	38	55	M2-M12	9	9			R-OGK-VDI40/FZ19	○
VDI40	FZ31	31	55	77	M6-M20	15	15			R-OGK-VDI40/FZ31	●
VDI40	FZ48	48	79	110	M14-M33	24	24			R-OGK-VDI40/FZ48	○
VDI50	FZ48	48	79	110	M14-M33	24	24			R-OGK-VDI50/FZ48	○

Тип OGK с системой внутреннего подвода СОЖ по запросу



8



								WELDON	POLYGONAL											
Аксессуары <table border="1" style="width: 100%; text-align: center;"> <tr> <td>Адаптеры 188</td> <td>Адаптеры 190</td> <td>Цанги 192</td> </tr> <tr> <td></td> <td></td> <td></td> </tr> <tr> <td>FZS</td> <td>FZA</td> <td>ER</td> </tr> </table>								Адаптеры 188	Адаптеры 190	Цанги 192				FZS	FZA	ER				
Адаптеры 188	Адаптеры 190	Цанги 192																		
FZS	FZA	ER																		
Стандарт								DIN-1835 B+E		ISO 26623-1										
Внутреннее охлаждение																				
Хвостовик	Адаптер	D	A	H	M	↔		INDEX		INDEX										
						(-)	(+)													
W20	FZ19	19	38	41	M2-M12	9	9	R-OGK-W20/FZ19	○											
W20	FZ31	31	55	63	M6-M20	15	15	R-OGK-W20/FZ31	○											
W25	FZ19	19	38	41	M2-M12	9	9	R-OGK-W25/FZ19	●											
W25	FZ31	31	55	63	M6-M20	15	15	R-OGK-W25/FZ31	●											
W32	FZ19	19	38	41	M2-M12	9	9	R-OGK-W32/FZ19	○											
W32	FZ31	31	55	63	M6-M20	15	15	R-OGK-W32/FZ31	●											
W32	FZ48	48	79	109	M14-M33	24	24	R-OGK-W32/FZ48	○											
W40	FZ19	19	38	41	M2-M12	9	9	R-OGK-W40/FZ19	○											
W40	FZ31	31	55	63	M6-M20	15	15	R-OGK-W40/FZ31	○											
W40	FZ48	48	79	98	M14-M33	24	24	R-OGK-W40/FZ48	○											
C40	FZ19	19	41	48	M2-M12	7,5	7,5			R-OGK-C40/FZ19	○									
C40	FZ31	31	60	71	M6-M20	10	10			R-OGK-C40/FZ31	○									
C50	FZ19	19	41	48	M2-M12	7,5	7,5			R-OGK-C50/FZ19	○									
C50	FZ31	31	60	71	M6-M20	10	10			R-OGK-C50/FZ31	○									
C63	FZ19	19	41	73	M2-M12	7,5	7,5			R-OGK-C63/FZ19	○									
C63	FZ31	31	60	97	M6-M20	10	10			R-OGK-C63/FZ31	○									
C63	FZ48	48	86	124	M12-M33	17,5	17,5			R-OGK-C63/FZ48	○									
C80	FZ19	19	41	45	M2-M12	7,5	7,5			R-OGK-C80/FZ19	○									
C80	FZ31	31	60	60	M6-M20	10	10			R-OGK-C80/FZ31	○									
C80	FZ48	48	86	107	M12-M33	17,5	17,5			R-OGK-C80/FZ48	○									

Тип OGK с системой внутреннего подвода СОЖ по запросу

Информация:

- Для станков с правосторонним вращением шпинделя
 - Держатель инструмента имеет осевую компенсацию на сжатие и растяжение и предохранительную муфту
- $I = U / U_0$
 U - скорость резания
 U_0 - скорость обратного вращения

Аксессуары

Хвостовики

R-TM-MK2/JT6



Цанги

197



RF

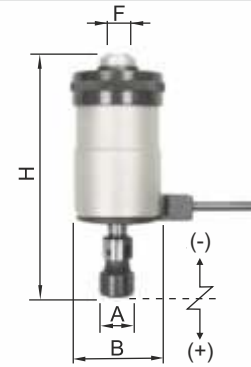

Стандарт

JT6 / M20 (+ МК DIN-228 B)

F	Оправка	H	B	A	U _{max} [1/min]	I	M	В комплекте		INDEX	
								RF	TM		
JT6	RF15	134	55	23	1500	1,6	M2-M7	J116, J117	MK1, MK3	R-OGN-JT6/RF15-Z	●
JT6	RF23	158	75	28	1000	1,75	M5-M12	J421, J422	MK3, MK4	R-OGN-JT6/RF23-Z	●
M20	RF32	205	91	40	600	1,7	M5-M18	J441, J445	MK3, MK4	R-OGN-M20/RF32-Z	●

Держатели инструмента поставляются в комплекте с аксессуарами - комплектность в таблице



Информация:

- Адаптеры с предохранительной муфтой предназначены для оправок типа ОГК с осевой компенсацией
- Предохранительная муфта может предотвратить поломку инструмента, в случае превышения допустимой силы резания



Размер					FZS13	FZS19	FZS31	FZS48	FZS60
d / A / H / h					13 / 23 / 21 / 6	19 / 32 / 25 / 8	31 / 50 / 34 / 4	48 / 72 / 45 / 1	60 / 95 / 68 / 3
M	DIN	D	∅	INDEX	R-FZS13	R-FZS19	R-FZS31	R-FZS48	R-FZS60
M 2	371	2,8	2,1	M2 D2,8 DIN	○	●			
M 3	371	3,5	2,7	M3 D3,5 DIN	○	●			
M 4	371	4,5	3,4	M4 D4,5 DIN	○	●			
M 5	371	6	4,9	M5 D6 DIN	○	●			
M 6	371	6	4,9	M6 D6 DIN	○	●	●		
M 8	371	8	6,2	M8 D8 DIN		●	●		
M 8	376	6	4,9	M8 D6 DIN		○	○		
M 10	371	10	8	M10 D10 DIN		●	●	○	
M 10	376	7	5,5	M10 D7 DIN		○	○		
M 12	376	9	7	M12 D9 DIN		●	●	○	
M 14	376	11	9	M14 D11 DIN		○	●	●	
M 16	376	12	9	M16 D12 DIN			●	○	
M 18	376	14	11	M18 D14 DIN			●	●	
M 20	376	16	12	M20 D16 DIN			●	○	○
M 22	376	18	14,5	M22 D18 DIN			●	●	○
M 24	376	18	14,5	M24 D18 DIN			○	●	○
M 27	376	20	16	M27 D20 DIN			○	●	○
M 30	376	22	18	M30 D22 DIN				○	○
M 33	376	25	20	M33 D25 DIN				○	○
M 36	376	28	22	M36 D28 DIN					●
M 39	376	32	24	M39 D32 DIN					○
M 42	376	32	24	M42 D32 DIN					●
M 45	376	36	29	M45 D36 DIN					○
M 48	376	36	29	M48 D36 DIN					○

Удлиненная версия быстросменных держателей типа FZSL и FL - по запросу



Информация:

· Адаптеры предназначены для держателей инструмента типов OGK и OG

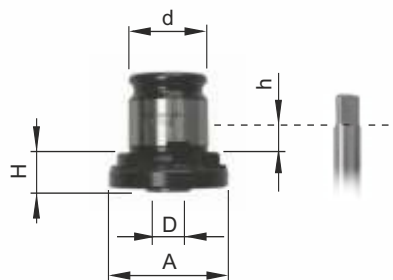

Размер					FZ13	FZ19	FZ31	FZ48	FZ60
d / A / H / h					13 / 22 / 7 / 8	19 / 30 / 7 / 10	31 / 46 / 11 / 19	48 / 68 / 14 / 25	60 / 83 / 42 / 29
M	DIN	D	∅	INDEX	R-FZ13	R-FZ19	R-FZ31	R-FZ48	R-FZ60
M 2	371	2,8	2,1	M2 D2,8 DIN	○	○			
M 3	371	3,5	2,7	M3 D3,5 DIN	○	●			
M 4	371	4,5	3,4	M4 D4,5 DIN	○	●			
M 5, M6	371	6	4,9	M5, M6 D6 DIN	○	●	●		
M 8	371	8	6,2	M8 D8 DIN		●	●		
M 10	371	10	8	M10 D10 DIN		●	●		
M 12	376	9	7	M12 D9 DIN		●	●		
M 14	376	11	9	M14 D11 DIN		○	○	○	
M 16	376	12	9	M16 D12 DIN			●	○	
M 18	376	14	11	M18 D14 DIN			○	○	
M 20	376	16	12	M20 D16 DIN			●	○	
M 22, M24	376	18	14,5	M24 D18 DIN			○	○	○
M 27	376	20	16	M27 D20 DIN				○	○
M 30	376	22	18	M30 D22 DIN				○	○
M 33	376	25	20	M33 D25 DIN				○	○
M 36	376	28	22	M36 D28 DIN					○
M 39, M42	376	32	24	M42 D32 DIN					○
M 45, M48	376	36	29	M48 D36 DIN					○

Удлиненная версия быстросменных держателей типа FZSL и FL - по запросу



Быстросменные адаптеры типа FZN для плашек - по запросу



8



Информация:

- Адаптеры предназначены для держателей инструмента типов OGK и OG
- При использовании в адаптерах стандартных цанг типа ER - адаптер имеет крепежные винты

*После каждой смены метчика необходимо затянуть адаптеры.



Аксессуары



Размер	Цанга	H	h	A	d	D	M	INDEX	
FZA19	ER16	29,5	8,5	28	19	2-10	M3-M12	R-FZA19/ER16	●
FZA31	ER25	38,5	15	42	31	2-16	M6-M20	R-FZA31/ER25	●

Информация:

- Переходные втулки предназначены для держателей типов OGK и OG для установки в быстросменные адаптеры типов FZS, FZ и адаптеры FZA

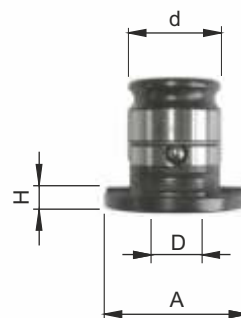

Редукционные	H	A	d	D	INDEX	
19/13	6	30	19	13	R-FR19/13	○
31/19	8,5	46	31	19	R-FR31/19	●
48/31	7	68	48	31	R-FR48/31	●
60/48	13	92	60	48	R-FR60/48	○

Информация:

- Адаптеры предназначены для держателей OGSS
- При использовании в адаптерах стандартных цанг типа ER - адаптер имеет крепежные винты

**После каждой смены метчика необходимо затянуть адаптеры.*

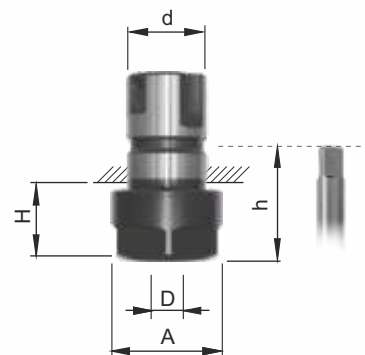

Аксессуары



Размер	Цанга	H	h	A	d	D	M	INDEX	
A20	ER16	24	42	28	20	2-10	M3-M12	R-A20/ER16	●
A32	ER25	28	59	42	32	2-16	M6-M20	R-A32/ER25	●
A50	ER40	32	75	63	50	6-26	M14-M33	R-A50/ER40	●



DIN-6499

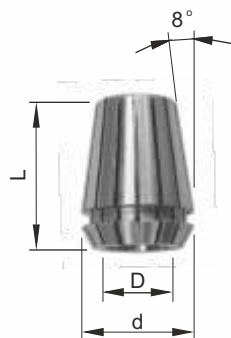

РАЗМЕРЫ				ER16	ER20	ER25	ER32	ER40	ER50
d / L				17 / 27,5	21 / 31,5	26 / 34	33 / 40	41 / 46	52 / 60
D	M		INDEX	R-ER16	R-ER20	R-ER25	R-ER32	R-ER40	R-ER50
	DIN 371	DIN 376							
2			D2	●	●	●	●		
3	M2-M2,5	M3,5-M4	D3	●	●	●	●	○	
4	M3-M3,5	M5	D4	●	●	●	●	○	
5	M4	M6	D5	●	●	●	●	○	
6	M4,5-M5-M6	M8	D6	●	●	●	●	●	○
7	M7	M9-M10	D7	●	●	●	●	○	○
8	M8	M11	D8	●	●	●	●	●	○
9	M9	M12	D9	●	●	●	●	●	○
10	M10		D10	●	●	●	●	●	○
11		M14	D11		○	●	●	●	○
12		M16	D12		●	●	●	●	○
13		M16	D13		○	●	●	○	○
14		M18	D14			●	●	●	○
15		M18	D15			●	●	○	○
16		M20	D16			●	●	●	○
18		M22-M24	D18				●	●	○
20		M27	D20				●	●	○
22		M30	D22					●	○
25		M33	D25					●	○
28		M36	D28					●	○
32		M39-42	D32						○

Комплекты цанг на странице 209



DIN-6499

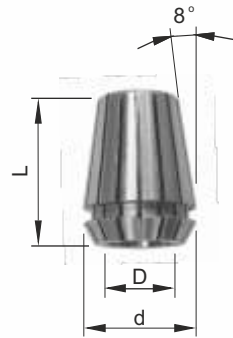

Размеры					ERC16	ERC20	ERC25	ERC32	ERC40	ERC50
d / L					17 / 27,5	21 / 31,5	26 / 34	33 / 40	41 / 46	52 / 60
D	∠	M		INDEX	R-ERC16	R-ERC20	R-ERC25	R-ERC32	R-ERC40	R-ERC50
		DIN 371	DIN 376							
3,5	2,7	M3	M4-M4,5	D3,5	○	○	●	○		
4,0	3,0	M3,5		D4	○	○	○	○		
4,5	3,4	M4	M6	D4,5	○	○	●	○		
5,0	4,0			D5	○	○	○	○		
5,5	4,3		M7	D5,5	○	○	○	○		
6,0	4,9	M4,5-M5-M6	M8	D6	●	●	●	●	○	
7,0	5,5	M7	M9-M10	D7	○	○	●	●	○	
8,0	6,2	M8	M11	D8	●	●	●	●	○	○
9,0	7,0	M9	M12	D9		○	●	●	○	○
10,0	8,0	M10		D10		●	●	●	○	○
11,0	9,0		M14	D11			○	●	○	○
12,0	9,0		M16	D12			●	●	●	○
14,0	11,0		M18	D14				●	○	○
16,0	12,0		M20	D16				●	●	○
18,0	14,5		M22-M24	D18					○	○
20,0	16,0		M27	D20					○	○
22,0	18,0		M30	D22						○
25,0	20,0		M33	D25						○
28,0	22,0		M36	D28						○
32,0	24,0		M39-42	D32						○



DIN-6499

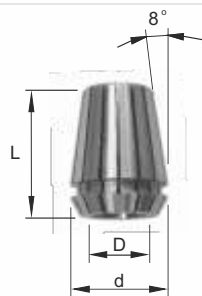

Размеры				ERG16	ERG20	ERG25	ERG32	ERG40
d / L				17 / 27,5	21 / 31,5	26 / 34	33 / 40	41 / 46
D	M		INDEX	R-ERG16	R-ERG20	R-ERG25	R-ERG32	R-ERG40
	DIN 371	DIN 376						
3	M2-M2,5	M3,5-M4	D3	○	○	○	○	
4	M3-M3,5	M5	D4	○	○	○	○	○
5	M4	M6	D5	○	○	○	○	○
6	M4,5-M5-M6	M8	D6	○	○	●	●	○
7	M7	M9-M10	D7	○	○	○	○	○
8	M8	M11	D8	○	○	●	●	○
9	M9	M12	D9	○	○	○	○	○
10	M10		D10	○	○	●	●	○
11		M14	D11		○	○	○	○
12		M16	D12		○	●	●	○
13		M16	D13		○	○	○	○
14		M18	D14		○	●	●	○
15		M18	D15			○	○	○
16		M20	D16			●	●	○
18		M22-M24	D18				○	○
20		M27	D20				●	○
22		M30	D22					○
25		M33	D25					○

Цанги с резиновой прокладкой и с квадратным профилем зажима для метчиков

DIN-6499

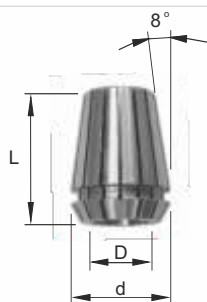

Размеры				ERCG16	ERCG20	ERCG25	ERCG32	ERCG40	
d / L				17 / 27,5	21 / 31,5	26 / 34	33 / 40	41 / 46	
D	□	M		INDEX	R-ERCG16	R-ERCG20	R-ERCG25	R-ERCG32	R-ERCG40
		DIN 371	DIN 376						
4	3,0	M3,5		D4	○	○	●	○	
4,5	3,4	M4	M6	D4,5	○	○	○	○	
5	4			D5	○	○	●	○	
5,5	4,3		M7	D5,5	○	○	○	○	
6	4,9	M4,5-M5-M6	M8	D6	○	○	○	○	
7	5,5	M7	M9-M10	D7	●	●	●	●	○
8	6,2	M8	M11	D8	○	○	●	●	○
9	7	M9	M12	D9	●	●	●	●	○
10	8	M10		D10		○	●	●	○
11	9		M14	D11		●	●	●	○
12	9		M16	D12			○	●	○
14	11		M18	D14			●	●	●
16	12		M20	D16				●	○
18	14,5		M22-M24	D18				●	●
20	16			D20					○

Прокладки и гайки



Уплотнительные прокладки для ER40 и ER50 доступны на заказ

Уплотнительные прокладки для ER20	INDEX
3-3.5mm	R-U20/D3
3.5-4mm	R-U20/D3,5
4-4.5mm	R-U20/D4
4.5-5mm	R-U20/D4,5
5-5.5mm	R-U20/D5
5.5-6mm	R-U20/D5,5
6-6.5mm	R-U20/D6
6.5-7mm	R-U20/D6,5
7-7.5mm	R-U20/D7
7.5-8mm	R-U20/D7,5
8-8.5mm	R-U20/D8
8.5-9mm	R-U20/D8,5
9-9.5mm	R-U20/D9
9.5-10mm	R-U20/D9,5
10-10.5mm	R-U20/D10
10.5-11mm	R-U20/D10,5
11-11.5mm	R-U20/D11
11.5-12mm	R-U20/D11,5
12-12.5mm	R-U20/D12

Уплотнительные прокладки для ER25	INDEX
3-3.5mm	R-U25/D3
3.5-4mm	R-U25/D3,5
4-4.5mm	R-U25/D4
4.5-5mm	R-U25/D4,5
5-5.5mm	R-U25/D5
5.5-6mm	R-U25/D5,5
6-6.5mm	R-U25/D6
6.5-7mm	R-U25/D6,5
7-7.5mm	R-U25/D7
7.5-8mm	R-U25/D7,5
8-8.5mm	R-U25/D8
8.5-9mm	R-U25/D8,5
9-9.5mm	R-U25/D9
9.5-10mm	R-U25/D9,5
10-10.5mm	R-U25/D10
10.5-11mm	R-U25/D10,5
11-11.5mm	R-U25/D11
11.5-12mm	R-U25/D11,5
12-12.5mm	R-U25/D12
12.5-13mm	R-U25/D12,5
13-13.5mm	R-U25/D13
13.5-14mm	R-U25/D13,5
14-14.5mm	R-U25/D14
14.5-15mm	R-U25/D14,5
15-15.5mm	R-U25/D15
15.5-16mm	R-U25/D15,5
16-16.5mm	R-U25/D16

Зажимные гайки по DIN 6499 без герметизации системы внутреннего охлаждения

Примечание: Max. Nm указывает максимально допустимый крутящий момент для каждого размера гайки

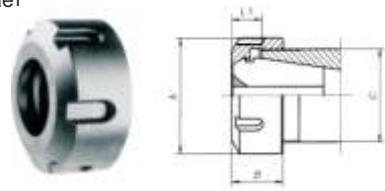

Type	A mm	B mm	max. Nm	INDEX
ER11	19	11,3	30	R-NT11-SE
ER16	28	17,5	70	R-NT16-SE
ER20	34	19	100	R-NT20-SE

Type	A mm	B mm	max. Nm	INDEX
ER25	42	20	130	R-NT25-S
ER40	63	25,5	220	R-NT40-S
ER50	78	35,3	300	R-NT50-S

Зажимные гайки по DIN 6499 с герметизацией системы внутреннего охлаждения

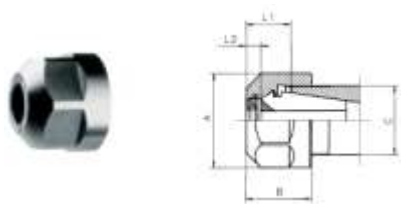

Примечание: Max. Nm указывает максимально допустимый крутящий момент для каждого размера гайки



Type	A mm	B mm	max. Nm	INDEX
ER16	28	22,5	70	R-NTU16-SE
ER20	34	24,5	100	R-NTU20-SE

Type	A mm	B mm	max. Nm	INDEX
ER25	42	25	130	R-NTU25-S
ER40	63	30,5	220	R-NTU40-S
ER50	78	42,5	300	R-NTU50-S





Информация:

- Применение переходных втулок приводит к уменьшению скорости на 50%

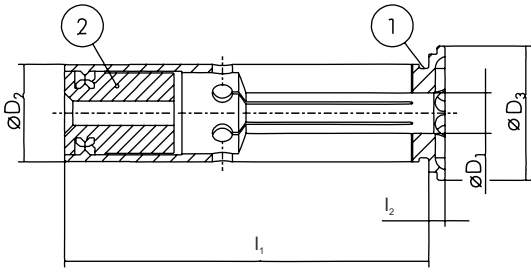

Размеры		TR20	TR32
d / L		20 / 54	32 / 64
D	INDEX	R-TR20	R-TR32
3	D3	○	○
4	D4	○	○
5	D5	○	○
6	D6	○	○
7	D7	○	○
8	D8	○	○
9	D9	○	○
10	D10	○	○
11	D11	○	○
12	D12	○	○
13	D13	○	○
14	D14	○	○
15	D15	○	○
16	D16	○	○
17	D17	○	○
18	D18	○	○
19	D19		○
20	D20		○
21	D21		○
22	D22		○
23	D23		○
24	D24		○
25	D25		○
26	D26		○
27	D27		○
28	D28		○

Основные аксессуары							TRH20	TRH20-EK
① Уплотнительное кольцо ② Регулируемый бампер для установки длины								
								
охлаждение							-	EK с охлаждением водяной завесой.
D ₁	D ₂	D ₃	l ₁	l ₂	m	INDEX	R-TRH20	R-TRH20-EK
3,0	20	24	50,5	2,0	0,1	D3	○	○
4,0	20	24	50,5	2,0	0,1	D4	○	○
5,0	20	24	50,5	2,0	0,1	D5	○	○
6,0	20	24	50,5	2,0	0,1	D6	○	○
7,0	20	24	50,5	2,0	0,1	D7	○	○
8,0	20	24	50,5	2,0	0,1	D8	○	○
9,0	20	24	50,5	2,0	0,1	D9	○	○
10,0	20	24	50,5	2,0	0,1	D10	○	○
11,0	20	24	50,5	2,0	0,1	D11	○	○
12,0	20	24	50,5	2,0	0,1	D12	○	○
13,0	20	24	50,5	2,0	0,1	D13	○	○
14,0	20	24	50,5	2,0	0,1	D14	○	○
15,0	20	24	50,5	2,0	0,1	D15	○	○
16,0	20	24	50,5	2,0	0,1	D16	○	○



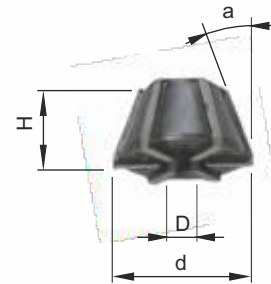

Размер	d	H	a	D	M	INDEX	
RF15	15	12	13	2,5-4,5	M2-M4	R-RF15/J116	●
RF15	15	12	13	4,5-6,5	M4-M7	R-RF15/J117	●
RF23	23	13	20	3,5-6,5	M5-M6	R-RF23/J421	●
RF23	23	13	20	6,5-10,0	M6-M12	R-RF23/J422	●
RF32	32,5	16	22,5	4,5-10,0	M8-M12	R-RF32/J441	●
RF32	32,5	16	22,5	10,0-15,0	M10-M18	R-RF32/J445	●

Информация:

- Предназначаются для держателей инструмента с хвостовиком по ISO по DIN-698711
- IK - Вариант с внутренним подводом СОЖ

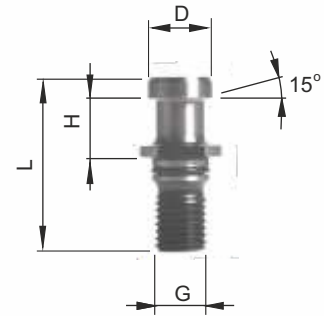
C ISO A

Стандарт

ISO-7388/2A

Размер ISO	IK	O-RING	L	H	D	G	INDEX	
30			44	19	12	M12	R-C-ISO-A-30	○
30	●		44	19	12	M12	R-C-ISO-A-30-ИК	○
40		●	54	20	19	M16	R-C-ISO-A-40	○
40	●	●	54	20	19	M16	R-C-ISO-A-40-ИК	○
50		●	74	25	28	M24	R-C-ISO-A-50	○
50	●	●	74	25	28	M24	R-C-ISO-A-50-ИК	○

Информация:

- Предназначаются для держателей инструмента с хвостовиком по ISO по DIN-69871
- IK - Вариант с внутренним подводом СОЖ

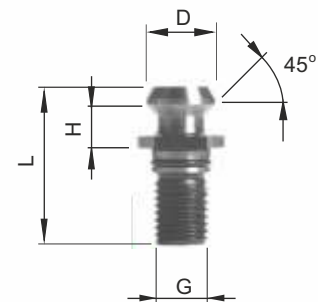
C ISO B

Стандарт

ISO-7388/2B

Размер ISO	IK	O-RING	L	H	D	G	INDEX	
30			34,0	8,15	13,35	M12	R-C-ISO-B-30	○
30	●		34,0	8,15	13,35	M12	R-C-ISO-B-30-ИК	○
40		●	44,5	11,15	18,95	M16	R-C-ISO-B-40	●
40	●	●	44,5	11,15	18,95	M16	R-C-ISO-B-40-ИК	●
50		●	65,5	17,95	29,10	M24	R-C-ISO-B-50	○
50	●	●	65,5	17,95	29,10	M24	R-C-ISO-B-50-ИК	○

8



Информация:

- Предназначаются для держателей инструмента с хвостовиком по ISO по DIN-69871
- Вариант с внутренним подводом СОЖ

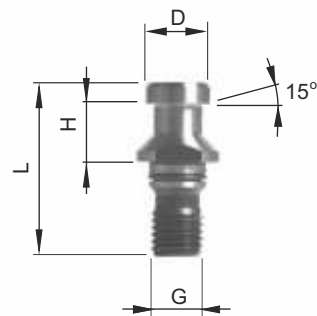
C DIN

Стандарт

DIN-69872

Размер ISO	ИК	O-RING	L	H	D	G	INDEX	
30			44	19	13	M12	R-C-DIN-30	○
30	●		44	19	13	M12	R-C-DIN-30-ИК	○
40		●	54	20	19	M16	R-C-DIN-40	●
40	●	●	54	20	19	M16	R-C-DIN-40-ИК	●
50		●	74	25	28	M24	R-C-DIN-50	○
50	●	●	74	25	28	M24	R-C-DIN-50-ИК	○

Информация:

- Предназначаются для держателей инструмента с хвостовиком по ISO по MAS-BT
- ИК - Вариант с внутренним подводом СОЖ

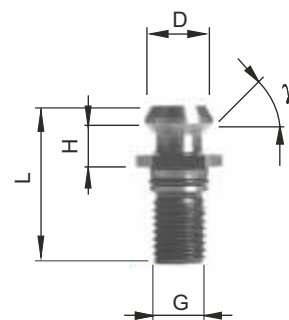
C BT

Размер MAS-BT	ИК	O-RING	L	H	D	G	g	INDEX	
30			43	18	11	M12	45	R-C-BT-30/45	○
30	●		43	18	11	M12	45	R-C-BT-30/45-ИК	○
30			43	18	11	M12	60	R-C-BT-30/60	○
30	●		43	18	11	M12	60	R-C-BT-30/60-ИК	○
40		●	60	28	15	M16	45	R-C-BT-40/45	●
40	●	●	60	28	15	M16	45	R-C-BT-40/45-ИК	●
40		●	60	28	15	M16	60	R-C-BT-40/60	○
40	●	●	60	28	15	M16	60	R-C-BT-40/60-ИК	○
40		●	60	28	15	M16	90	R-C-BT-40/90	○
40	●	●	60	28	15	M16	90	R-C-BT-40/90-ИК	○
50		●	85	35	23	M24	45	R-C-BT-50/45	○
50	●	●	85	35	23	M24	45	R-C-BT-50/45-ИК	○
50		●	85	35	23	M24	60	R-C-BT-50/60	○
50	●	●	85	35	23	M24	60	R-C-BT-50/60-ИК	○
50		●	85	35	23	M24	90	R-C-BT-50/90	○
50	●	●	85	35	23	M24	90	R-C-BT-50/90-ИК	○

НАБОРЫ ИНСТРУМЕНТОВ



	CZD-40 HSS (M3 ÷ M20)	Наборы инструментов для нарезания резьбы	203
	CZD-85 HSS (M3 ÷ M24, M8x1 ÷ M24x1,5)	Наборы инструментов для нарезания резьбы	203
	CZB-29 HSS (M3 ÷ M12)	Наборы инструментов для нарезания резьбы	204
	CZB-29W HSS (M3 ÷ M12)	Наборы инструментов для нарезания резьбы	204
	CZB-31 HSS (M3 ÷ M12)	Наборы инструментов для нарезания резьбы	205
	CZB-31 INOX (M3 ÷ M12)	Наборы инструментов для нарезания резьбы	205
	CZP-31 HSS mini (M1 ÷ M2,5)	Наборы инструментов для нарезания резьбы	206
	CZP-7 BIT HSS (M3 ÷ M10)	Наборы инструментов для нарезания резьбы	206
	CZP-8 B HSSE OPTI OX (M3 ÷ M12)	Наборы инструментов для нарезания резьбы	207
	CZP-8 R40 HSSE OPTI OX (M3 ÷ M12)	Наборы инструментов для нарезания резьбы	207
	CZP-8 C HSSE OPTI OX (M3 ÷ M12)	Наборы инструментов для нарезания резьбы	207
	CZW-19 HSSE INOX TiN (Ø1 ÷ Ø10)	Наборы инструментов для нарезания резьбы	207
	CZW-24 HSSE INOX TiN (Ø1 ÷ Ø10,5)	Наборы инструментов для нарезания резьбы	207
	CZW-25 HSSE INOX TiN (Ø1 ÷ Ø13)	Наборы инструментов для нарезания резьбы	207
	CZP-6 DIN-335-C (Ø6,3 ÷ Ø25)	Наборы зенковок	208
	WDG (M3 ÷ M12)	Наборы сверл для извлечения сломанных метчиков	208
	R-ER11	Наборы цанг	209
	R-ER16	Наборы цанг	209
	R-ER20	Наборы цанг	209
	R-ER25	Наборы цанг	209
	R-ER32	Наборы цанг	209
	R-ER40	Наборы цанг	209
	CZD-8 MSRh (M3 ÷ M12)	Наборы калибров для проверки резьбы	210
	CZD8 MSBg (M3 ÷ M12)	Наборы калибров для проверки резьбы	210

CZD-40 HSS M3÷M20
INDEX Z1-040011-0000



	Метчики	Круглые плашки	Резьбомер	Ручные воротки	Плашко-держатели	Отвертка
СОСТАВ НАБОРА	DIN-352 HSS dla M3÷M12 DIN-352/2 HSS dla M14÷M20	DIN-EN 22 568 HSS 800	MWGa	PBPc	PBGa	RWWe
	M3 M4 M5 M6 M7, M8, M10 M12 M14 M16 M20	25 x 9: M3 M4 M5 M6 M7 M8 M10 38 x 14: M12 M14 M16 M20	0,4 ÷ 6 mm	Nr 2 zm.: 2,5 ÷ 9 mm Nr 3: 4,9 ÷ 14 mm	25 x 9 mm 38 x 14 mm	4 x 90 mm
ГАБАРИТЫ	475 x 255 x 40 mm					
ВЕС	3,40 kg					

CZD-85 HSS M3÷M24
INDEX Z1-085011-0000

	Метчики	Круглые плашки	Резьбомер	Ручные воротки	Плашко-держатели	T-образный метчи-ко-держатель	Отвертка	Кольцо-вставка
СОСТАВ НАБОРА	DIN-352 HSS - M3÷M12 DIN-352/2 HSS - M14÷M24 DIN-2181/2 HSS - MF 14x1,25	DIN-EN 22 568 HSS 800	MWGa	PBPc	PBGa		RWWe	
	M3, M4, M5, M6, M8, M10, M12, M14, M16, M18, M20, M22, M24, M8x1, M10x1, M12x1,25, M12x1,5, M14x1,25, M14x1,5, M16x1,5, M18x1,5, M20x1,5, M22x1,5, M24x1,5	M3 M4 M5 M6 M8 M10 M12 M14 M16 M18 M20 M22 M24 M8x1 M10x1 M12x1,25 M12x1,5 M14x1,25 M14x1,5 M16x1,5 M18x1,5 M20x1,5 M22x1,5 M24x1,5	0,4 ÷ 6 mm	Nr 2 zm.: 2,5 ÷ 9 mm Nr 3: 4,9 ÷ 14 mm	25 x 9 mm 38 x 14 mm 45 x 18 mm 55 x 22 mm	Nr 1 (M2 ÷ M5)	4 x 90 mm	38 x 2 45 x 2 55 x 3
ГАБАРИТЫ	550 x 380 x 70 mm							
ВЕС	12 kg							



CZB-29 HSS M3÷M12
INDEX Z1-029012-0000

СОСТАВ НАБОРА	Метчики	Круглые плашки
	DIN-352/3 HSS	DIN-EN 22 568 HSS 800
		
M3 M4 M5 M6 M8 M10 M12	25 x 9: M3 M4 M5 M6 M8 M10 M12	
ГАБАРИТЫ	270 x 230 x 30 mm	
ВЕС	0,85 кг	





CZB-29W HSS M3÷M12
INDEX Z1-029112-0000

СОСТАВ НАБОРА	Метчики	Круглые плашки	Сверла
	DIN-352/2 HSS	DIN-EN 22 568 HSS 800	DIN-338 N HSS
			
M3, M4, M5, M6, M8, M10, M12	25 x 9: M3, M4, M5, M6, M8, M10, M12	2,5; 3,3; 4,2; 5,0; 6,8; 8,5; 10,2	
ГАБАРИТЫ	340 x 290 x 40 mm		
ВЕС	1,20 кг		

CZB-31 HSS M3÷M12
INDEX Z1-031012-0000





СОСТАВ НАБОРА	Метчики	Круглые плашки	Ручные воротки	Плашко-держатели	Отвертка
	DIN-352/3 HSS	DIN-EN 22 568 HSS 800	PBPc	PBGa	RWWe
	 M3 M4 M5 M6 M8 M10 M12	 25 x 9: M3 M4 M5 M6 M8 M10 M12	 Nr 1,5: 2,5 ÷ 8 mm	 25 x 9 mm	 4 x 90 mm
ГАБАРИТЫ	340 x 290 x 40 mm				
ВЕС	1,52 кг				

CZB-31 INOX M3÷M12
INDEX Z2-031012-0000



СОСТАВ НАБОРА	Метчики	Круглые плашки	Ручные воротки	Плашко-держатели	Отвертка
	DIN-352/3 HSSE INOX	DIN-EN 22 568 HSSE INOX	PBPc	PBGa	RWWe
	 M3 M4 M5 M6 M8 M10 M12	 25 x 9: M3 M4 M5 M6 M8 M10 M12	 Nr 1,5: 2,5 ÷ 8 mm	 25 x 9 mm	 4 x 90 mm
ГАБАРИТЫ	340 x 290 x 40 mm				
ВЕС	1,52 кг				



CZP-31 HSS mini M1÷M2,5
INDEX Z1-031115-0000

СОСТАВ НАБОРА	Метчики	Круглые плашки	Универсальный вороток для метчиков и плашек
	DIN-352/2 HSS	DIN-EN 22 568 HSS	
			
	M1 M1,1 M1,2 M1,4 M1,6 M1,8 M2 M2,2 M2,5	12 x 3: M1 M1,1 M1,2 M1,4 M1,6 M1,8 M2, 16 x 3: M2,2 M2,5	
ГАБАРИТЫ	155 x 85 x 12 mm		
ВЕС	0,17 кг		

CZP-7 BIT HSS M3÷M10
Z1-007020-0310

обозначения	M _{d1}		INDEX	Z1-007020
CZP-7 BIT HSS	M 3 ÷ M 10	1/4"	0310	●

CZP-8 B HSSE OPTI OX	CZP-8 R40 HSSE OPTI OX	CZB-8 C HSSE OPTI OX
INDEX Z2-081015-0000	INDEX Z2-085015-0000	INDEX Z2-082015-0000
СОСТАВ НАБОРА		
Метчики		
DIN-371 B ISO2 (6H) HSSE OPTI OX	DIN-371 C ISO2 (6H) R40 HSSE OPTI OX	DIN-371 C ISO2 (6H) C HSSE OPTI OX
M3 M4 M5 M6 M8 M10	M3 M4 M5 M6 M8 M10	M3 M4 M5 M6 M8 M10
DIN-376 B ISO2 (6H) HSSE OPTI OX	DIN-376 C ISO2 (6H) R40 HSSE OPTI OX	DIN-376 C ISO2 (6H) C HSSE OPTI OX
M12	M12	M12
Габариты 145 x 90 x 37 mm		Вес 0,23 kg
CZW-19 HSSE INOX TiN Ø1,0 ÷ Ø10	CZW-24 HSSE INOX TiN Ø1,0 ÷ Ø10,5	CZW-25 HSSE INOX TiN Ø1,0 ÷ Ø13
INDEX Z2-019315-0000	INDEX Z2-024315-0000	INDEX Z2-025315-0000
СОСТАВ НАБОРА		
1 1,5 2 2,5 3 3,5 4 4,5 5 5,5 6 6,5 7 7,5 8 8,5 9 9,5 10	1 1,5 2 2,5 3 3,5 4 4,5 5 5,5 6 6,5 7 7,5 8 8,5 9 9,5 10 + размеры резьбы 3,3 4,2 6,8 10,2 10,5	1 1,5 2 2,5 3 3,5 4 4,5 5 5,5 6 6,5 7 7,5 8 8,5 9 9,5 10 10,5 11 11,5 12 12,5 13



CZP-6 DIN-335-C Ø6,3 ÷ Ø25
INDEX Z2-065015-0000

СОСТАВ НАБОРА	Набор зенковок	
	DIN-335-C HSSE Co8 TiCN	
		
	6,3 10,4 16,5 20,5 25	
ГАБАРИТЫ	125 x 75 mm	
ВЕС	0,20 кг	

WDG M3÷M12
INDEX W9-900002-0000

СОСТАВ НАБОРА	Наборы сверл для извлечения сломанных метчиков	
	WDG	
		
	M3 M4 M5 M6 M8 M10 M12	
ГАБАРИТЫ	290 x 340 x 40 mm	
ВЕС	1,225 кг	

R-ER11	R-ER16	R-ER20
INDEX: R-ER11-13BOX	INDEX: R-ER16-10BOX	INDEX: R-ER20-12BOX
		
Пластиковая коробка D.1÷7 x 0,5 mm	Пластиковая коробка D.1÷10 x 1 mm	Пластиковая коробка D.2÷13 x 1 mm

R-ER25	R-ER32	R-ER40
INDEX: R-ER25-15BOX	INDEX: R-ER32-18BOX	INDEX: R-ER40-23BOX
		
Алюминиевая коробка D.2÷16 x 1 mm	Алюминиевая коробка D.3÷20 x 1 mm	Алюминиевая коробка D.4÷26 x 1 mm



CZD-8 MSRh M3÷M12
Index: Z3-200120-0312

Допуски калибров в соответствии с ISO 1502



СОСТАВ НАБОРА	Набор калибров	
	MSRh 6G	
		
	M3 M4 M5 M6 M8 M10 M12	
ГАБАРИТЫ	145 x 145 x 35 mm	
ВЕС	0,542 кг	

CZD-8 MSBg M3÷M12
Index: Z3-302161-0312

Допуски калибров в соответствии с ISO 1502



СОСТАВ НАБОРА	Набор калибров	
	MSBg 6H	
		
	M3 M4 M5 M6 M8 M10 M12	
ГАБАРИТЫ	290 x 175 x 35 mm	
ВЕС	0,600 кг	

Специальные средства, приспособления, станки



СТРАНИЦЫ КАТАЛОГА

213-220

Специальные средства для нарезания резьбы, СОЖ	213
Воротки для метчиков, переходники, плашкодержатели	214
Держатели метчиков с увеличенным диаметром хвостовика	215-217
Пневматические станки для нарезания резьбы	218-219
Станки для заточки сверл	220

TEREBOR

Специальный состав для нарезания резьбы

Назначение: для нарезания резьбы в труднообрабатываемых сталях,

Особенно:

- нержавеющие стали,
- химически стойкие стали,
- твердые и закаленные стали



ОБЪЕМ	INDEX
250 ml	T0-100110-0250
500 ml	T0-100110-0500
5 l	T0-100110-5000

VARIOCUT В 40

Эмульсия для нарезания резьбы на станках (СОЖ)

Назначение: для нарезания резьбы в инструментальных
И мягких конструкционных сталях



ОБЪЕМ	INDEX
250 ml	T0-100310-0250
500 ml	T0-100310-0500
5 l	T0-100310-5000
200 l*	По запросу

*Для использования в токарных станках

CIMTAP

Паста для нарезания резьбы

Назначение: для нарезания резьбы в инструментальных
И мягких конструкционных сталях



ОБЪЕМ	INDEX
1 l	T0-100410-1000

Воротки для метчиков

Обозначение	□	l	M		INDEX
			ISO-529	DIN-352	
PBPc/m - 0	2 ÷ 4,5	125	M1 ÷ M5	M1 ÷ M4	V0-303000-0204
PBPc/m - 1	3,15 ÷ 6,3	205	M4 ÷ M8	M3 ÷ M11	V0-303010-0306
PBPc/m - 1,5	2,5 ÷ 7,1	205	M3 ÷ M9	M3 ÷ M12	V0-303015-0207
PBPc/m - 2	3,55 ÷ 9	305	M4,5 ÷ M14	M4,5 ÷ M16	V0-303020-0309
PBPc/m - 4	5,6 ÷ 16	395	M7 ÷ M30	M11 ÷ M27	V0-303040-0516

T-образные воротки для метчиков

Обозначение	□	l	M		INDEX
			ISO-529	DIN-352	
PT Nr 1	2,0 ÷ 4,0	55	M1 ÷ M5	M1 ÷ M4	V0-310000-0205
PT Nr 1D	2,0 ÷ 4,0	200	M1 ÷ M5	M1 ÷ M4	V0-311000-0205
PT Nr 2	4,0 ÷ 7,1	90	M6 ÷ M12	M5 ÷ M12	V0-320000-0612
PT Nr 2D	4,0 ÷ 7,1	250	M6 ÷ M12	M5 ÷ M12	V0-321000-0612
PT Nr 3	9,0 ÷ 11,2	110	M14 ÷ M20	M14 ÷ M18	V0-330000-1420

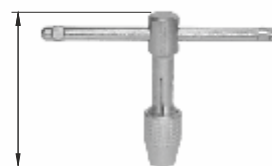
Воротки с решеточным механизмом

Обозначение	l	M	INDEX
PG Nr 1	85	M3 ÷ M6	V0-310500-0306
PG Nr 1 D	250	M3 ÷ M6	V0-311500-0306
PG Nr 2	110	M6 ÷ M12	V0-320500-0612
PG Nr 2 D	300	M6 ÷ M12	V0-321500-0612

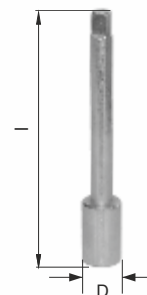

Переходники для метчиков

Обозначение	□	l	D	M		INDEX
				ISO-529	DIN-352	
PBNa - 5	5,0	110	11	M6		V0-200000-0050
PBNa - 6,3	6,3	120	14	M8, M11		V0-200000-0063
PBNa - 7,1	7,1	125	15	M9, M12		V0-200000-0071
PBNa - 8	8,0	130	17	M10		V0-200000-0080
PBNa - 9	9,0	130	19	M14	M14, M16	V0-200000-0090
PBNa - 10	10,0	140	21	M16		V0-200000-0100

Плашкодержатели

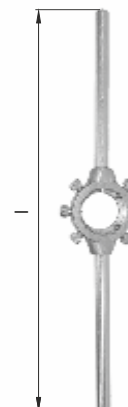
Обозначение	l	M	INDEX
PBGa/m - 16x5	160	M1 ÷ M2,5	V0-103000-1605
PBGa/m - 20x5	185	M3 ÷ M6	V0-103000-2005
PBGa/m - 25x9	220	M7 ÷ M9	V0-103000-2509
PBGa/m - 30x11	260	M10 ÷ M11	V0-103000-3011
PBGa/m - 38x14	310	M12 ÷ M14	V0-103000-3814
PBGa/m - 45x18	400	M16 ÷ M20	V0-103000-4518
PBGa/m - 55x22	500	M22 ÷ M24	V0-103000-5522
PBGa/m - 65x25	560	M27 ÷ M36	V0-103000-6525

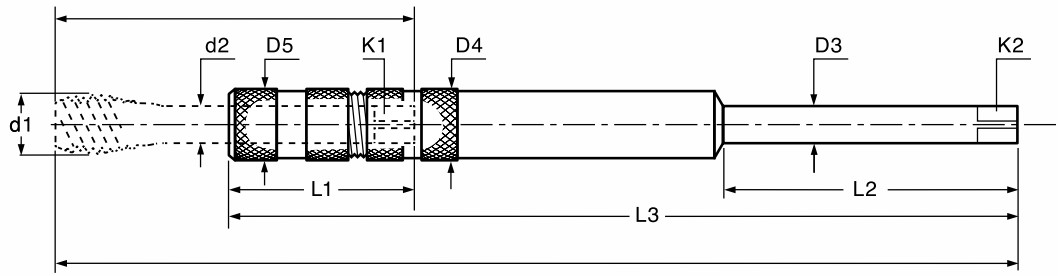



Короткие

Обозначение	D ₁		D ₂	D ₃	D ₄ =D ₅	L ₁	L ₂	a ₁	a ₂	INDEX
	DIN-371	DIN-376								
PBNm 2,8/2,1-6/4,9-130	M2 - M2,6	M4	2,8	6	6,1	22	130	2,1	4,9	V0-211130-0206
PBNm 3,5/2,7-6/4,9-130	M3	M4,5 - M5	3,5	6	7,5	23	130	2,7	4,9	V0-211130-0306
PBNm 4,5/3,4-6/4,9-130	M4	M6	4,5	6	8,4	23	130	3,4	4,9	V0-211130-0406
PBNm 6/4,9-7/5,5-130	M4,5 - M6	M8	6	7	12,1	26	130	4,9	5,5	V0-211130-0607
PBNm 7/5,5-7/5,5-130	M7	M9 - M10	7	7	12,1	26	130	5,5	5,5	V0-211130-0707
PBNm 8/6,2-8/6,2-130	M8	M11	8	8	13	30	130	6,2	6,2	V0-211130-0808
PBNm 9/7-9/7-130	M9	M12	9	9	15	31	130	7	7	V0-211130-0909
PBNm 10/8-10/8-130	M10	-	10	10	15	33	130	8	8	V0-211130-1010
PBNm 11/9-11/9-130		M14	11	11	18	36	130	9	9	V0-211130-1111
PBNm 12/9-12/9-200		M16	12	12	18	36	130	9	9	V0-211130-1212
PBNm 14/11-14/11-200		M18	14	14	22	42	200	11	11	V0-211200-1414
PBNm 16/12-16/12-200		M20	16	16	22	42	200	12	12	V0-211200-1616
PBNm 18/14,5-18/14,5-200		M22/M24	18	18	26	43	200	14,5	14,5	V0-211200-1818
PBNm 20/16-20/16-200		M27	20	20	28	48	200	16	16	V0-211200-2020

Длинные

Обозначение	D ₁		D ₂	D ₃	D ₄ =D ₅	L ₁	L ₂	a ₁	a ₂	INDEX
	DIN-371	DIN-376								
PBNm 2,8/2,1-6/4,9-230	M2-M2,6	M4	2,8	6	6,1	22	230	2,1	4,9	V0-211230-0206
PBNm 3,5/2,7-6/4,9-230	M3	M4,5-M5	3,5	6	7,5	23	230	2,7	4,9	V0-211230-0306
PBNm 4,5/3,4-6/4,9-230	M4	M6	4,5	6	8,4	23	230	3,4	4,9	V0-211230-0406
PBNm 6/4,9-7/5,5-230	M4,5 - M6	M8	6	7	12,1	26	230	4,9	5,5	V0-211230-0607
PBNm 7/5,5-7/5,5-230	M7	M9 - M10	7	7	12,1	26	230	5,5	5,5	V0-211230-0707
PBNm 8/6,2-8/6,2-230	M8	M11	8	8	13	30	230	6,2	6,2	V0-211230-0808
PBNm 9/7-9/7-230	M9	M12	9	9	15	31	230	7	7	V0-211230-0909
PBNm 10/8-10/8-230	M10	-	10	10	15	33	230	8	8	V0-211230-1010
PBNm 11/9-11/9-230		M14	11	11	18	36	230	9	9	V0-211230-1112
PBNm 12/9-12/9-230		M16	12	12	18	36	230	9	9	V0-211230-1212
PBNm 14/11-14/11-330		M18	14	14	22	42	330	11	11	V0-211330-1414
PBNm 16/12-16/12-330		M20	16	16	22	42	330	12	12	V0-211330-1616
PBNm 18/14,5-18/14,5-330		M22/M24	18	18	26	43	330	14,5	14,5	V0-211330-1818
PBNm 20/16-20/16-330		M27	20	20	28	48	330	16	16	V0-211330-2020

ИК

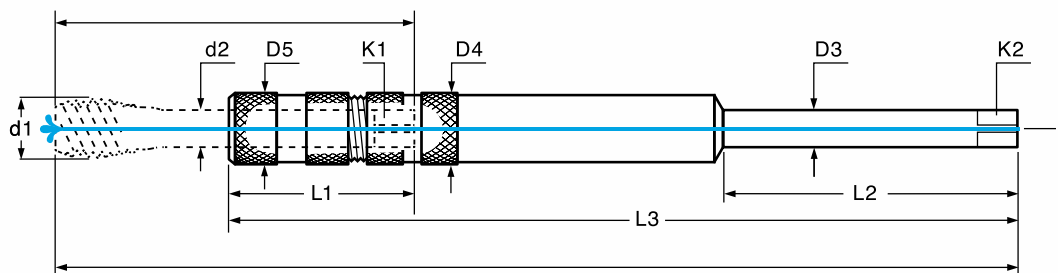

Короткие

Обозначение	D ₁		D ₂	D ₃	D ₄ =D ₅	L ₁	L ₂	a ₁	a ₂	INDEX
	DIN-371	DIN-376								
PBNm 2,8/2,1-6/4,9-130	M2 - M2,6	M4	2,8	6	6,1	22	130	2,1	4,9	V0-211135-0206
PBNm 3,5/2,7-6/4,9-130	M3	M4,5 - M5	3,5	6	7,5	23	130	2,7	4,9	V0-211135-0306
PBNm 4,5/3,4-6/4,9-130	M4	M6	4,5	6	8,4	23	130	3,4	4,9	V0-211135-0406
PBNm 6/4,9-7/5,5-130	M4,5 - M6	M8	6	7	12,1	26	130	4,9	5,5	V0-211135-0607
PBNm 7/5,5-7/5,5-130	M7	M9 - M10	7	7	12,1	26	130	5,5	5,5	V0-211135-0707
PBNm 8/6,2-8/6,2-130	M8	M11	8	8	13	30	130	6,2	6,2	V0-211135-0808
PBNm 9/7-9/7-130	M9	M12	9	9	15	31	130	7	7	V0-211135-0909
PBNm 10/8-10/8-130	M10	-	10	10	15	33	130	8	8	V0-211135-1010
PBNm 11/9-11/9-130		M14	11	11	18	36	130	9	9	V0-211135-1111
PBNm 12/9-12/9-200		M16	12	12	18	36	130	9	9	V0-211135-1212
PBNm 14/11-14/11-200		M18	14	14	22	42	200	11	11	V0-211205-1414
PBNm 16/12-16/12-200		M20	16	16	22	42	200	12	12	V0-211205-1616
PBNm 18/14,5-18/14,5-200		M22/M24	18	18	26	43	200	14,5	14,5	V0-211205-1818
PBNm 20/16-20/16-200		M27	20	20	28	48	200	16	16	V0-211205-2020

Длинные

Обозначение	D ₁		D ₂	D ₃	D ₄ =D ₅	L ₁	L ₂	a ₁	a ₂	INDEX
	DIN-371	DIN-376								
PBNm 2,8/2,1-6/4,9-230	M2-M2,6	M4	2,8	6	6,1	22	130	2,1	4,9	V0-211235-0206
PBNm 3,5/2,7-6/4,9-230	M3	M4,5-M5	3,5	6	7,5	23	130	2,7	4,9	V0-211235-0306
PBNm 4,5/3,4-6/4,9-230	M4	M6	4,5	6	8,4	23	130	3,4	4,9	V0-211235-0406
PBNm 6/4,9-7/5,5-230	M4,5 - M6	M8	6	7	12,1	26	230	4,9	5,5	V0-211235-0607
PBNm 7/5,5-7/5,5-230	M7	M9 - M10	7	7	12,1	26	230	5,5	5,5	V0-211235-0707
PBNm 8/6,2-8/6,2-230	M8	M11	8	8	13	30	230	6,2	6,2	V0-211235-0808
PBNm 9/7-9/7-230	M9	M12	9	9	15	31	230	7	7	V0-211235-0909
PBNm 10/8-10/8-230	M10	-	10	10	15	33	230	8	8	V0-211235-1010
PBNm 11/9-11/9-230		M14	11	11	18	36	230	9	9	V0-211235-1112
PBNm 12/9-12/9-230		M16	12	12	18	36	230	9	9	V0-211235-1212
PBNm 14/11-14/11-330		M18	14	14	22	42	330	11	11	V0-211335-1414
PBNm 16/12-16/12-330		M20	16	16	22	42	330	12	12	V0-211335-1616
PBNm 18/14,5-18/14,5-330		M22/M24	18	18	26	43	330	14,5	14,5	V0-211335-1818
PBNm 20/16-20/16-330		M27	20	20	28	48	330	16	16	V0-211335-2020

ИК-Н6

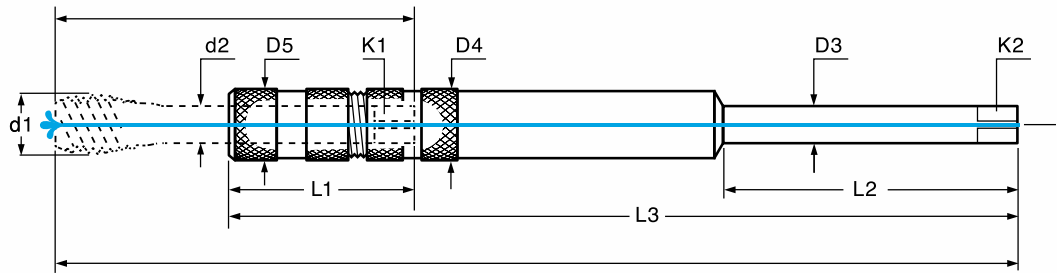

Короткие

Обозначение	D ₁		D ₂	D ₃	D ₄ =D ₅	L ₁	L ₂	a ₁	a ₂	INDEX
	DIN-371	DIN-376								
PBNm 2,8/2,1-6/4,9-130	M2 - M2,6	M4	2,8	6	6,1	22	130	2,1	4,9	VO-211136-0206
PBNm 3,5/2,7-6/4,9-130	M3	M4,5 - M5	3,5	6	7,5	23	130	2,7	4,9	VO-211136-0306
PBNm 4,5/3,4-6/4,9-130	M4	M6	4,5	6	8,4	23	130	3,4	4,9	VO-211136-0406
PBNm 6/4,9-7/5,5-130	M4,5 - M6	M8	6	8	12,1	26	130	4,9	6,2	VO-211136-0607
PBNm 7/5,5-7/5,5-130	M7	M9 - M10	7	8	12,1	26	130	5,5	6,2	VO-211136-0707
PBNm 8/6,2-8/6,2-130	M8	M11	8	8	13	30	130	6,2	6,2	VO-211136-0808
PBNm 9/7-9/7-130	M9	M12	9	9	15	31	130	7	8	VO-211136-0909
PBNm 10/8-10/8-130	M10	-	10	10	15	33	130	8	8	VO-211136-1010
PBNm 11/9-11/9-130	-	M14	11	12	18	36	130	9	9	VO-211136-1111
PBNm 12/9-12/9-200	-	M16	12	12	18	36	130	9	9	VO-211136-1212
PBNm 14/11-14/11-200	-	M18	14	14	22	42	200	11	11	VO-211206-1414
PBNm 16/12-16/12-200	-	M20	16	16	22	42	200	12	12	VO-211206-1616
PBNm 18/14,5-18/14,5-200	-	M22/M24	18	18	26	43	200	14,5	14,5	VO-211206-1818
PBNm 20/16-20/16-200	-	M27	20	20	28	48	200	16	16	VO-211206-2020

Длинные

Обозначение	D ₁		D ₂	D ₃	D ₄ =D ₅	L ₁	L ₂	a ₁	a ₂	INDEX
	DIN-371	DIN-376								
PBNm 6/4,9-7/5,5-230	M4,5 - M6	M8	6	8	12,1	26	230	4,9	6,2	VO-211236-0206
PBNm 7/5,5-7/5,5-230	M7	M9 - M10	7	8	12,1	26	230	5,5	6,2	VO-211236-0306
PBNm 8/6,2-8/6,2-230	M8	M11	8	8	13	30	230	6,2	6,2	VO-211236-0406
PBNm 9/7-9/7-230	M9	M12	9	10	15	31	230	7	8	VO-211236-0607
PBNm 10/8-10/8-230	M10	-	10	10	15	33	230	8	8	VO-211236-0707
PBNm 11/9-11/9-230	-	M14	11	12	18	36	230	9	9	VO-211236-0808
PBNm 12/9-12/9-230	-	M16	12	12	18	36	230	9	9	VO-211236-0909
PBNm 14/11-14/11-330	-	M18	14	14	22	42	330	11	11	VO-211336-1010
PBNm 16/12-16/12-330	-	M20	16	16	22	42	330	12	12	VO-211336-1616
PBNm 18/14,5-18/14,5-330	-	M22/M24	18	18	26	43	330	14,5	14,5	VO-211336-1818
PBNm 20/16-20/16-330	-	M27	20	20	28	48	330	16	16	VO-211336-2020

Резьбомеры

Метрическая резьба ISO DIN-13

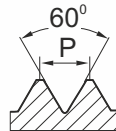

Резьба Витворта основной (крупный) шаг BS-84:1956

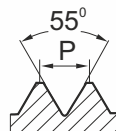

Обозначение	Диапазон шагов резьбы	Кол-во шаблонов	INDEX
60°	0,4 ÷ 7 mm	20	VO-600000-000
55°	62 ÷ 4 1"/P (TPI)	28	VO-550000-000
55°/60°	62 ÷ 4 1"/P (TPI) 0,25 ÷ 7 mm	58	VO-556000-000



МОДЕЛЬ СТАНКА	MPD-08/II	MPD-12/II	MPD-16/II	MPD-22/II	MPD-27/II
INDEX	P0-130000-10208	P0-130000-10312	P0-130000-10316	P0-130000-10322	P0-130000-10327
Диапазон размеров используемых метчиков	M2-M8	M3-M12	M3-M16	M3-M22	M3-M27
Частота вращения n [1/min]	700	400	300	120/300	70/220
Рабочая зона	Rmax=1900mm		Rmin=200mm		
Вес станка [кг]	23	23	27	39	39
Максимальный момент [Нм]	12	32	12	100	160
Расход воздуха [л/мин]	840	840	840	935	935
Адаптеры, входящие в комплект поставки	FZS19/... M2,3,4,5,6,8	FZS19/... M4,5,6,8,10,12	FZS31/... M6,8,10,12,14,16	FZS31/... M6,8,10,12,16,20	FZS31/... M8,10,12,16,20,24
Адаптеры, применение которых возможно на станке	-	FZS19/M3	FZS19/...M3,4,5 +FR31/19	FZS19/...M3,4,5 +FR-31/19; FZS31/...M14,18,22	FZS19/...M3,4,5 +FR-31/19; FZS31/...M6,14,18,22,27

Стандартная комплектация

- пневматический привод
- двойная рычажная система
- крепление к столу
- система подготовки воздуха
- радиальный рычаг
- шесть адаптеров для метчиков

Полный ассортимент адаптеров FZS и переходников FR на стр. 188 и 190



Приспособление для поворота шпинделя головки на угол 0-90°



МОДЕЛЬ	Вес	INDEX
MGO-08-90°	1,1 kg	P0-133000-00890
MGO-12-90°	1,1 kg	P0-133000-01290
MGO-16-90°	1,5 kg	P0-133000-01690
MGO-22-90°	1,5 kg	P0-133000-02290
MGO-27-90°	1,5 kg	P0-133000-02790

Магнитные основания для станков



Модель магнитного основания	Сила прижима	Размеры	Для станка	Вес	INDEX
MMP-300	300 kg	150x90x93	MPD-08,12,16	8,6 kg	P0-133000-00300
MMP-600	600 kg	224x115x120	MPD-22,27	21 kg	P0-133000-00600

Адаптеры для сверлильного патрона



Сверлильные патроны

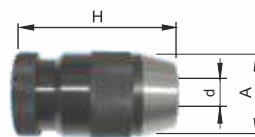

МОДЕЛЬ АДАПТЕРА	d	Конус	A	INDEX	МОДЕЛЬ ПАТРОНА	Конус	A	H	d	INDEX
FZA19/JT2	19	JT2	30	R-FZA19/JT2	OW-JT2/D8	JT2	38	68	0-8	R-OW-JT2/D8
FZA19/JT6	19	JT6	30	R-FZA19/JT6	OW-JT6/D13	JT6	48	90	0-13	R-OW-JT6/D13
FZA31/JT6	31	JT6	48	R-FZA31/JT6						

Пневмоинструмент для ручной нарезки резьбы

MPP-12-1

С гибкой головкой



MPP-12-3

С держателем для адаптеров FZS



МОДЕЛЬ ПНЕВМО-ИНСТРУМЕНТА	M	n [1/min]	Конус	Расход воздуха	Диаметр шланга	Вес	Комплектация	INDEX
MPP-12-1	M2-M12	250	B12	400 l/min	9,5 mm	2 kg	Handle	P0-136000-00121
MPP-12-3	M2-M12	250	B12	400 l/min	9,5 mm	1,5 kg	Handle + FZS19/...M3,4,5,6,8,10	P0-136000-00123

PMW-1300 2mm, 13mm
INDEX PMW-1300
Размеры: 305x172x180 (mm)

Диаметр сверла: 2, 13
Угол при вершине: 85°-140°
Электропитание: 220, 230 V 50Hz
Мощность двигателя: 90 W
Скорость вращения шлифовального круга: 6000 Оборотов в минуту
Вес: 10 kg
Алмазные шлифовальные круги: CBN#200
Цанги: ER-20

Аксессуары в комплекте:

Цанги ER20 2,5, 13 - 12 шт., Алмазные шлифовальные круги CBN#200 - 11шт., Ключ-шестигранник - 4мм и 6мм по 1шт

PMW-2000 3mm, 20mm
INDEX PMW-2000
Размеры: 480x260x240 (mm)

Диаметр сверла: 3, 20
Угол при вершине: 85°-140°
Электропитание: 220, 230 V 50Hz
Мощность двигателя: 450 W
Скорость вращения шлифовального круга: 4300 Оборотов в минуту
Вес: 21 kg
Алмазные шлифовальные круги: CBN#200
Цанги: ER-25

Аксессуары в комплекте:

Цанги ER25 3, 20 - 18 шт., Алмазные шлифовальные круги CBN#200 - 1 шт., Ключ-шестигранник - 4мм и 6мм по 1шт

PMW-3000 12mm, 26mm
INDEX PMW-3000
Размеры: 470x260x235 (mm)

Диаметр сверла: 12, 26, опциональный 8, 30
Угол при вершине: 85°-140°
Электропитание: 220, 230 V 50Hz
Мощность двигателя: 450 W
Скорость вращения шлифовального круга: 4300 Оборотов в минуту
Weight: 25 kg
Алмазные шлифовальные круги: CBN#200
Цанги: ER-40

Аксессуары в комплекте:





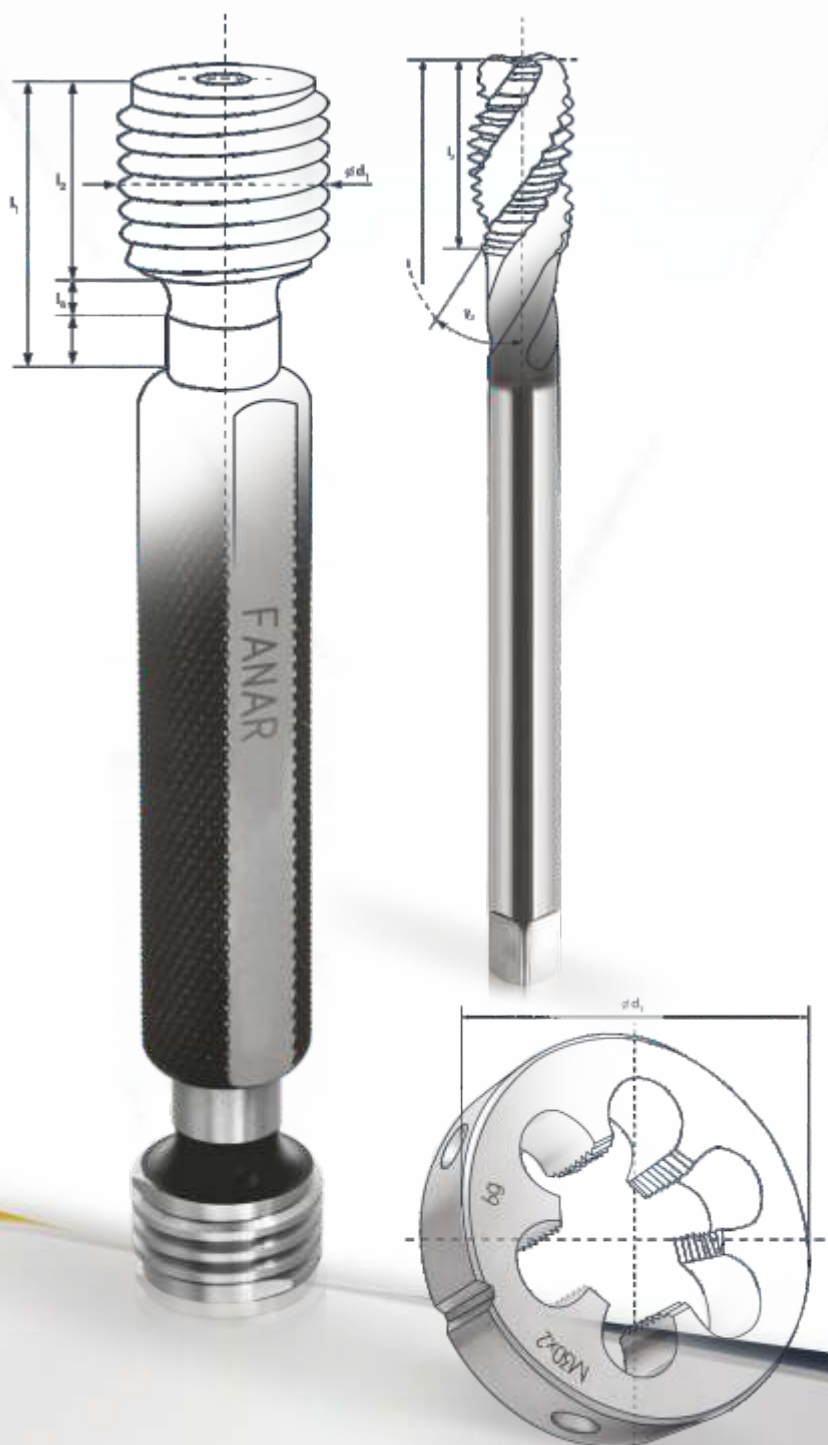













Цанги ER40 12, 26 - 15 szt., Алмазные шлифовальные круги CBN#200 - 1 шт., Ключ-шестигранник - 4мм и 6мм по 1шт

Техническая информация



1. Типы резьбы	223-224
2. Материалы применяемые в производстве инструмента	225
3. PVD-покрытия инструментов	225-227
4. Метчики	228-240
5. Раскатники	241-245
6. Плашки	246-247
7. Калибры	248-252
8. Спиральные сверла	253-255
9. Патроны для крепления машинных метчиков	256-262
10. Информационные таблицы	263-274
11. Бланки выбора инструмента	275-280
12. Сводная таблица индексов инструмента в соответствии со страницами их размещения в каталоге	281-282

1. ТИПЫ РЕЗЬБЫ

M		Основная метрическая резьба ISO DIN-13
MF		Мелкая метрическая резьба ISO DIN-13 (обозначение используется только для отличия от основной резьбы)
UNC		Американская унифицированная резьба ANSI B-1.1
UNF		Американская мелкая унифицированная резьба ANSI B-1.1
UNEF		Американская унифицированная резьба с особо мелким шагом ANSI B-1.1
G		Трубная резьба (Витворта) DIN-ISO 228 (идентична типу BSP)
Rp		Внутренняя трубная резьба Витворта PN-ISO 7/1 i DIN EN 10266-1 (идентична с резьбой типа BSPP)
Rc		Внутренняя трубная коническая резьба Витворта PN-ISO 7/1, DIN EN 10266-2 (идентична с резьбой типа BSPT)
NPT		Американская трубная коническая самоуплотняющаяся резьба ANSI B-1.20.1
NPTF		Американская трубная коническая самоуплотняющаяся резьба ANSI B 1.20.4
BSW		Резьба Витворта с основным шагом BS-84:1956 (старое обозначение - W)
BSF		Резьба Витворта с мелким шагом BS-84:1956
EG M		Метрическая резьба для вставок V-Coil
EG UNC		Американская унифицированная резьба для вставок V-Coil
Pg		Резьба для стальных труб DIN-40430 (P)
Tr		Трапецеидальная симметричная резьба DIN-103
R		Трубная наружная коническая резьба (Витворта) ISO-7/1 (идентична резьбе BSPT)
W80		Цилиндрическая резьба Витворта для крышек газовых баллонов PN-60/M-69225 и DIN 477
Rd		Круглая резьба, применяемая в пожарной технике PN-84/M-02035 и DIN 405

Rw		Велосипедная резьба PN-65/S-46001
FG		Велосипедная резьба для мопедов и мотоциклов DIN 79012
BSC		Британская велосипедная резьба, в настоящее время заменена на резьбу С.Е.І. BS 811
Ven		Резьба вентиляная PN-68/S-83200
Vg		Резьба вентиляная DIN 7756
E		Резьба Эдисона, применяется в электротехнике PN-82/E-02500
UN		Американская унифицированная резьба ANSI B-1.1 (с шагами: 4, 6, 8, 12, 16, 20, 28, 32 ниток на дюйм)
UNS		Американская унифицированная специальная резьба ANSI B-1.1
Whit. S		Специальная резьба Витворта BS 84
S		Трапецеидальная несимметричная резьба
W		Цилиндрическая резьба Витворта, для газовых баллонов PN-60/M-69224 и DIN 477
W		Коническая резьба Витворта, для газовых баллонов PN-82/M-69223 и DIN 477
NPSM (NPS)		Американская цилиндрическая трубная резьба ANSI B 1.20.1

2. МАТЕРИАЛЫ ПРИМЕНЯЕМЫЕ В ПРОИЗВОДСТВЕ ИНСТРУМЕНТА

Обозначение	Описание	Область применения
HSS	Быстрорежущая сталь	Круглые плашки, ручные метчики и машинные метчики общего назначения
HSSE (HSCo5)	Быстрорежущая сталь	Высокопроизводительные машинные метчики, круглые плашки, сверла для нержавеющей стали
HSSE-PM	Порошковая быстрорежущая сталь	Высокопроизводительные машинные метчики для обработки труднообрабатываемых материалов и раскатники
VHM	Твердый сплав	Высокопроизводительные машинные метчики для труднообрабатываемых материалов, сверла, фрезы

3. PVD-ПОКРЫТИЯ ИНСТРУМЕНТОВ

ПОКРЫТИЕ HL

Покрытие	TiAlN + WC/C
Структура	Многослойный наноккомпозит
Твердость	3000 HV _{0,05}
Макс. рабочая темп.	800°C
Коэффициент трения	0,15
Цвет покрытия	Темно-серый 

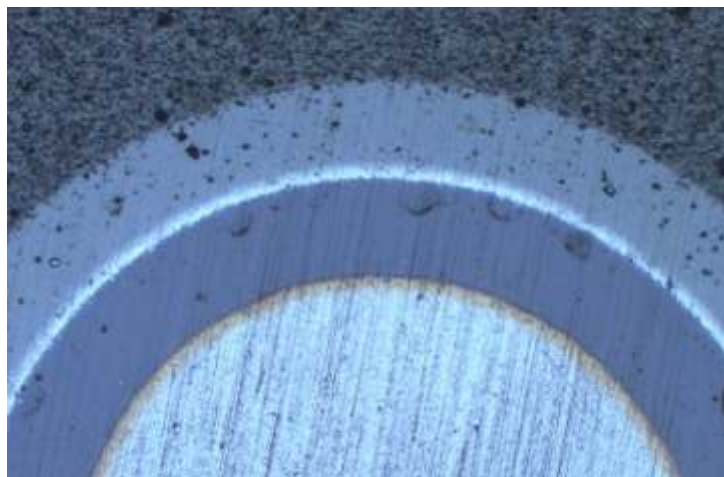

Высокоэффективные свойства покрытия HL были достигнуты благодаря применению продвинутой наноккомпозитной структуры. Слой TiAlN своей высокой твердостью и термостойкостью обеспечивает стабильную, устойчивую к истиранию основу покрытия. Верхний слой WC/C состоит из нанокристаллов карбида вольфрама, окруженных углеродным слоем, и обладает превосходными трибологическими свойствами. Твердые частички WC обеспечивают стойкость к истиранию, сохраняя при этом превосходные скользящие свойства углерода. Сочетание преимуществ этих двух слоев делает покрытие HL идеальным для обработки широкого спектра материалов. Благодаря нему улучшается эвакуация стружки, снижается усилие резания, а также обеспечивается защита режущей кромки от воздействия высоких температур. Инструменты с покрытием HL могут работать с минимальным количеством смазки (MQL). Покрытие предназначено для обработки материалов из групп P, M, K, N, S.

PVD-ПОКРЫТИЯ ИНСТРУМЕНТОВ

ПОКРЫТИЕ TN2

Покрытие	TiAlN + TiN
Структура	Двуслойная наноструктура
Твердость	3500 HV _{0,05}
Макс. рабочая темп.	800°C
Коэффициент трения	0,3
Цвет покрытия	Золото 

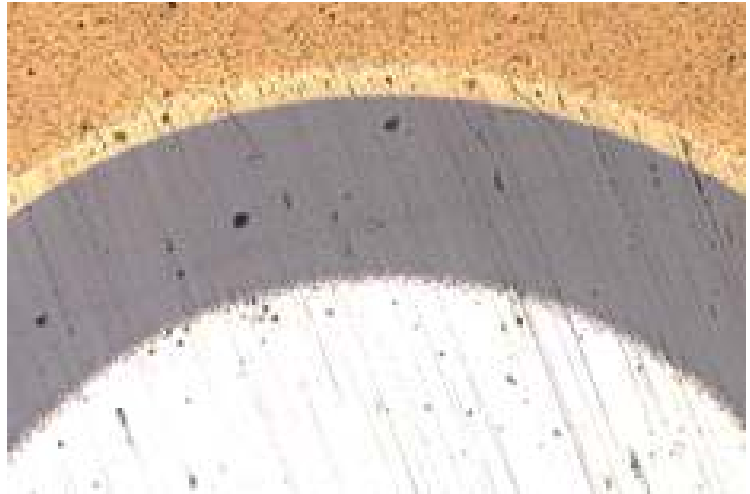

Двухслойное покрытие TN2, изготовленное бескапельным методом с точной обработкой поверхности, отличается высокой устойчивостью к истиранию, высоким температурам и низким коэффициентом трения. Уменьшение трения значительно увеличивает срок службы инструмента, а также улучшает качество поверхности, обработанной инструментом. Объединив чрезвычайно твердый слой TiAlN с ковким слоем TiN, мы получили интеллектуальную саморегулирующуюся структуру поверхности инструмента, которая приспосабливается к связанным с обработкой усилиям, тем самым улучшая сопротивление инструмента на разрыв. Покрытие TN2 предназначено, в частности, для инструментов для обработки материалов группы P (для Rm < 1000 МПа) и материалов из групп M, K, N.

ПОКРЫТИЕ TC

Покрытие	TiN + TiCN
Структура	Многослойная
Твердость	3700 HV _{0,05}
Макс. рабочая темп.	400°C
Коэффициент трения	0,2
Цвет покрытия	Антрацит 



TC - многослойное покрытие общего назначения. Оно обладает очень высокой твердостью, хорошей прочностью и низким коэффициентом трения. Основной слой TiN обеспечивает высокую адгезию к инструменту и значительное сопротивление динамическим нагрузкам. Верхний слой TiCN / TiC своей высокой твердостью и низким коэффициентом трения обеспечивает очень хорошую стойкость к истиранию. Сочетание вышеуказанных свойств позволяет защитить края от образования наростов из обрабатываемого материала или зубурин. Из-за относительно низкой термостойкости необходимо применять надлежащее охлаждение инструмента. Покрытие предназначено в основном для инструментов для обработки материалов из групп P (в частности, с высокой прочностью Rm > 1000 МПа) K, N, H.

PVD-ПОКРЫТИЯ ИНСТРУМЕНТОВ

ПОКРЫТИЕ AT

Покрытие	AlTiN
Структура	Градиент
Твердость	3700 HV _{0,05}
Макс. рабочая темп.	900°C
Коэффициент трения	0,3
Цвет покрытия	Пурпурно-серый 

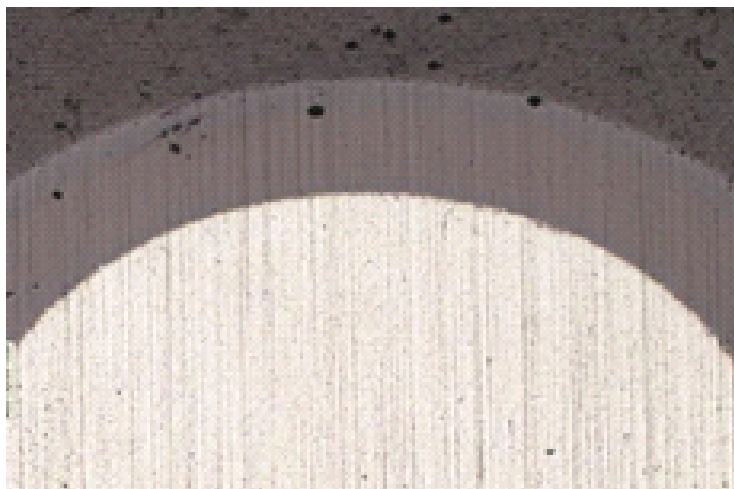

AT-покрытие с повышенным содержанием алюминия (Al) обладает высокой твердостью и термостойкостью. Во время обработки покрытие выделяет оксиды алюминия, которые служат дополнительной смазкой инструмента, а также создают термический барьер, предотвращающий износ покрытия даже в самых экстремальных условиях. Химический состав и наноградиентная структура обеспечивают высокую твердость покрытия. В результате достигается высокая стойкость к истиранию, что непосредственно приводит к увеличению срока службы инструмента. Покрытие может использоваться для инструментов, подверженных воздействию высоких температур, и подходит для работы как с хладагентом, так и без него. Покрытие предназначено для обработки материалов из групп P, M, K, N, S.

ПОКРЫТИЕ TiB₂

Покрытие	TiB ₂
Структура	Однослойная
Твердость	4000 HV _{0,05}
Макс. рабочая темп.	900°C
Цвет покрытия	Серебряный 



Материал покрытия, ТВ (диборид титана), представляет собой керамический материал с выдающимися свойствами в отношении его твердости и стойкости к истиранию. Благодаря тщательно подготовленной композиции (без сродства к алюминию) материал обеспечивает высокую химическую стойкость и предотвращает образование наростов обработанного материала на режущих кромках. Бескапельный метод изготовления покрытия позволяет получить очень гладкую поверхность, что, в свою очередь, дает очень высокое качество поверхностей заготовок. Покрытие предназначено для обработки материалов из группы N, главным образом алюминиевых сплавов (Si < 12%) и нелегированного титана.

4. МЕТЧИКИ

4.1. Конструктивные элементы метчиков (на примере метчика DIN-371)

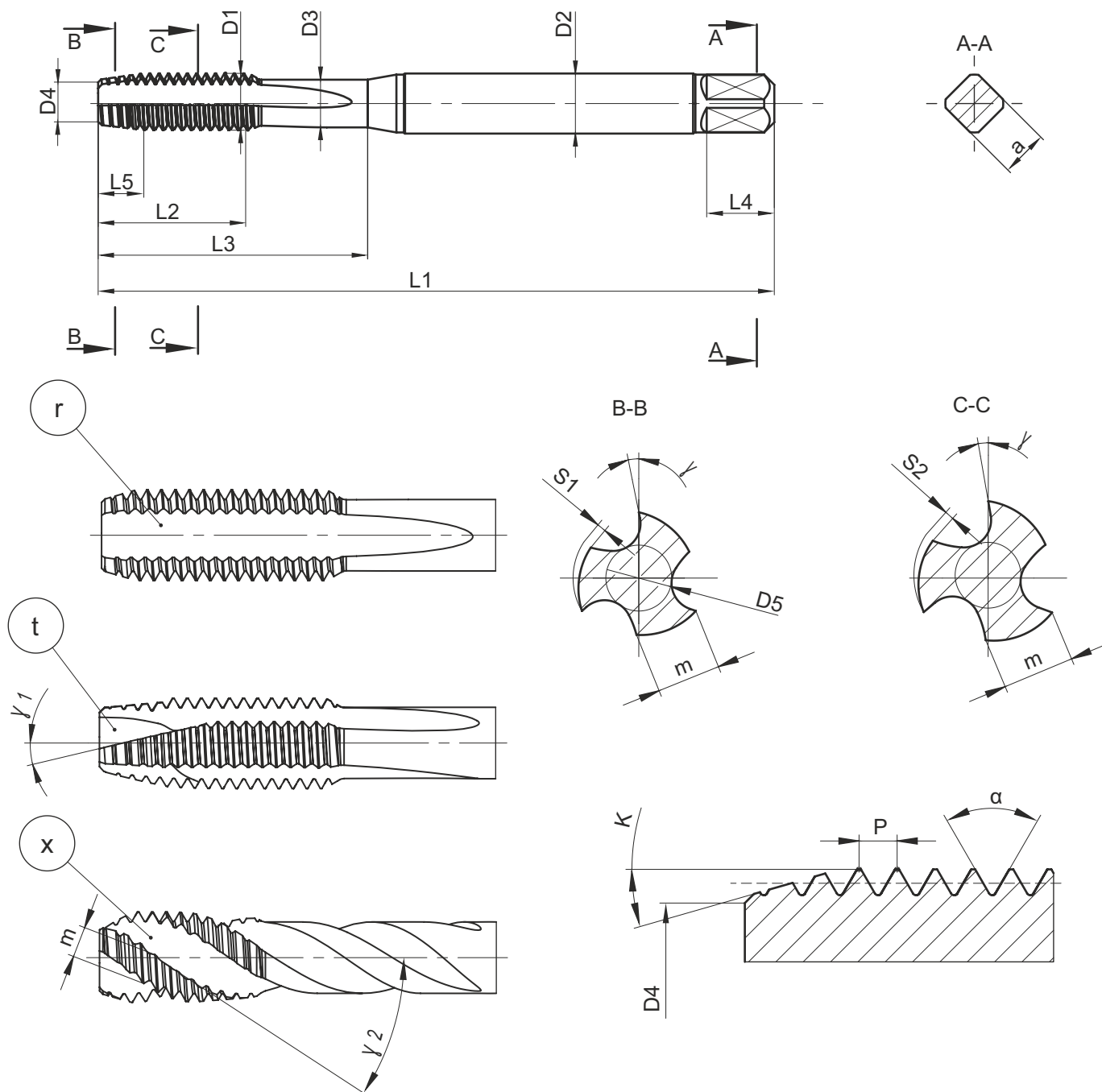

L_1 - общая длина
 L_2 - длина резьбовой части
 L_3 - рабочая длина
 L_4 - длина присоединительного квадрата
 L_5 - длина сбега резьбы
 a - размер присоединительного квадрата
 $\varnothing d_1$ - наружный диаметр резьбы
 $\varnothing d_2$ - диаметр хвостовика
 $\varnothing d_3$ - диаметр шейки
 $\varnothing d_4$ - внутренний диаметр резьбы
 $\varnothing d_5$ - диаметр центральной части
 m - ширина режущей части

S_1 - занижение затыловочной поверхности в зоне режущей части метчика
 S_2 - занижение затыловочной поверхности в зоне калибрующей части метчика
 P - шаг резьбы
 α - задний угол
 γ - передний угол режущей кромки
 γ_1 - угол подточки режущей кромки
 γ_2 - угол наклона спирали
 k - угол сбега резьбы
 r - прямая канавка
 x - винтовая канавка
 t - подточка режущей кромки
 z - число режущих кромок

4.2. Стандарты

Размеры, определяемые стандартами включают в себя такие величины, как общая длина метчика, длина резьбовой части, диаметр хвостовика и размер присоединительного квадрата, зависящие от номинального диаметра резьбы.

Обозначение стандарта	Описание
DIN-371	Машинные метчики с тонким хвостовиком для основной и мелкой метрической резьбы в диапазоне от M3 до M10 и для резьбы стандартов UNC, UNF, BSW, BSF в диапазоне размеров от 1/8" до 3/8"
DIN-376	Машинные метчики с усиленным хвостовиком для основной метрической резьбы и резьбы стандартов UNC и BSW
DIN-374	Машинные метчики с усиленным хвостовиком для мелкой метрической резьбы и резьбы стандартов UNF и BSF
DIN-5156	Машинные метчики с усиленным хвостовиком для резьбы стандартов G, Rp и Rc
ISO-2284	Короткие ручные и машинные метчики, для трубной резьбы стандартов G, Rp, Rc
DIN-352	Короткие ручные метчики для основной метрической резьбы, а также для резьбы стандартов UNC и BSW
DIN-2181	Короткие ручные метчики для мелкой метрической резьбы, а также для резьбы стандартов UNF и BSF
DIN-5157	Короткие ручные и машинные метчики для трубной резьбы стандартов G и Rp

Сбеги резьбы ручных метчиков

Комплект метчиков	Резьба метрическая обычная BSW, UNC		Резьба метрическая с мелким шагом BSF, UNF, UNEF		Резьба трубная G, Pg		Канавки
	L5 - длина сбега резьбы				K - угол сбега		
	L5	K	L5	K	L5	K	
№ 1 черновой	8P	5°	8P	5°	5P	7°	Прямые
№ 2 получистовой	4P	10°	-	-	-	-	
№ 3 чистовой	2P	20°	2P	20°	2P	20°	

4.3. Группы инструментов по применению

<p>MASTERTAP</p> <p>P M K N S</p>	<p>Группа машинных метчиков предназначенных для высокопроизводительного нарезания резьбы в широком спектре материалов, таких как сталь, нержавеющая сталь, чугун, цветные металлы, жаропрочные сплавы и титановые сплавы. Нарезание резьбы может выполняться на современных высокоэффективных обрабатывающих центрах с высокими скоростями резания, на старших типах станков с ЧПУ и на обычных машинах с более низкими параметрами обработки.</p>
<p>800X</p> <p>P M K N</p>	<p>Группа машинных метчиков, с улучшенными характеристиками группы 800. Данная группа имеет шире спектр использования: помимо черных металлов, позволяет дополнительно обрабатывать нержавеющую сталь. Кроме того, инновационные технологии, использованные при производстве группы 800X, позволяют удвоить долговечности и производительность, характерную для группы 800. Метчики группы 800X имеют наилучшее соотношение цены и качества при использовании их в мелкосерийном и средне серийном производстве.</p>
<p>800</p> <p>P K N</p>	<p>Для конструкционной, автоматной и низколегированной стали с прочностью на разрыв $600 \text{ МПа} \leq R_m \leq 800 \text{ МПа}$.</p>
<p>FAN-1200</p> <p>P</p>	<p>Для инструментальной и труднообрабатываемой стали с прочностью на разрыв $800 \text{ МПа} \leq R_m \leq 1200 \text{ МПа}$, а также для термообработанной стали до 38 HRC.</p>
<p>1400</p> <p>P</p>	<p>Для труднообрабатываемой и жаропрочной стали с прочностью на растяжение $1200 \text{ МПа} \leq R_m \leq 1400 \text{ МПа}$, а также для термообработанной стали до 44 HRC.</p>
<p>INOX</p> <p>P M</p>	<p>Для высоколегированной, нержавеющей и кислотостойкой стали с прочностью на растяжение $R_m \leq 1000 \text{ МПа}$.</p>
<p>GG</p> <p>K</p>	<p>Для обработки серого и высокопрочного чугуна</p>
<p>GAL</p> <p>N</p>	<p>Для литых алюминиевых сплавов с содержанием Si макс. 10%</p>
<p>HRC</p> <p>H</p>	<p>Для материалов, которые были закалены. Число рядом с символом указывает максимальную твердость обрабатываемого материала, по шкале HRC.</p>
<p>S-NC</p> <p>P M K N S</p>	<p>Для синхронного нарезания резьбы на станках с ЧПУ с функцией «жесткого нарезания резьбы» для широкого диапазона материалов с высокой скоростью резания.</p>
<p>Ms</p> <p>N</p>	<p>Для латуни и бронзы, дающей короткую стружку</p>

4.4. Типы сбега резьбы машинных метчиков

Обозначение сбега	Схема сбега	Длина сбега резьбы, измеряемая числом витков	Угол сбега
A		$6 \div 8 P$	5°
B		$3,5 \div 5,5 P$	8°
C		$2 \div 3 P$	17°
D		$3,5 \div 5 P$	8°
E		$1,5 \div 2 P$	23°
F		$1 P$	35°

4.5. Типы стружечных канавок машинных метчиков

Прямые стружечные канавки

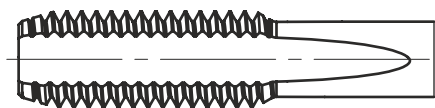

Для сквозных отверстий используют сбеги типа А или D. Для глухих отверстий применяют метчики со сбегами типа Е или F. Метчик со сбегом типа С можно использовать в обоих случаях.

Такой выбор метчиков рекомендуется для материалов, дающих короткую стружку. Канавки эвакуируют только часть стружки, которая медленно перемещается вдоль оси. Такие метчики не следует использовать для глубоких глухих отверстий или материалов, дающих длинную стружку. Длина нарезаемой резьбы для этих случаев рекомендована не более $1.5xD$

Прямые стружечные канавки со спиральной подточкой

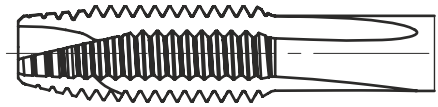

Предназначен для сквозных отверстий, с резьбой по всей длине отверстия.

Используется со сбегом типа В, рекомендуется для материалов, дающих длинную стружку. Спиральная подточка перемещает плотно сжатую стружку в направлении подачи и предотвращает засорение канавок. Охлаждающая жидкость имеет свободный доступ до рабочей зоны. Рекомендуется использовать для получения резьбы глубиной до $2xD$.

Винтовые стружечные канавки

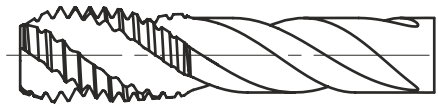



Используется со сбегом типа С и Е для глухих отверстий.

Рекомендуется для материалов, дающих длинную стружку. Спиральные канавки обеспечивают хорошую эвакуацию стружки в направлении из отверстия к хвостовику. В зависимости от диаметра отверстия возможно изготовление резьб глубиной до $3xD$.

Машинные метчики с винтовыми канавками нельзя использовать для сквозных отверстий.

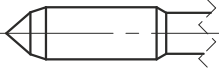
4.6. Центрирование метчиков с помощью конусов и центровочных отверстий. Типы конусов и центровочных отверстий.

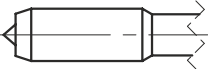
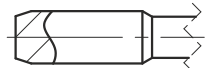
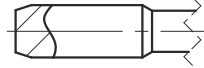
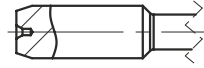
Рабочая часть		Хвостовик		
Полный конус	① 		⑤ Фаска	
Укороченный конус	② 			⑥ Внутреннее центровочное отверстие
Тип сбега Е (без центровочного отверстия)	③ 			
Внутреннее центровочное отверстие	④ 			

	Диаметр внешней резьбы (мм)	Тип центровочного отверстия со стороны режущей части			Тип центровочного отверстия со стороны хвостовика
		Типы сбега А, С, D,	Тип сбега В	Тип сбега Е	
DIN-371	$\leq 7,2$	①	①	③	⑤
	$7,2 \leq 8,2$	②	①	③	⑤
	$8,2 < 10,2$	②	②	③	⑤
DIN-374	$\leq 7,2$	①	①	③	⑤
DIN-376 DIN-5156	$> 7,2$	④	④	③	⑥

Длина полных конусов для выбранных типов резьбы (Длина укороченного конуса $L_{nak}=1.8$ мм)

M		MF	
M1	0,6	M2,5 x 0,35	1,9
M1,2	0,8	M2,6 x 0,35	1,9
M1,4	1,0	M3 x 0,35	1,3
M1,6	1,1	M 3,5 x 0,35	1,6
M1,7	1,1	M4 x 0,5	1,8
M1,8	1,3	M5 x 0,5	2,3
M2	1,4	M6 x 0,75	2,6
M2,5	1,8	M7 x ,75	3,1
M2,6	1,8		
M3	1,3		
M3,5	1,5		
M4	1,7		
M4,5	1,9		
M5	2,1		
M6	2,5		
M7	3,0		
UNC		UNF	
No 4-40	2,0	No 4-48	2,1
No 5-40	1,3	No 5-44	1,4
No 6-32	1,4	No 6-40	1,5
No 8-32	1,8	No 8-36	1,8
No 10-24	2,0	No 10-32	2,1
No 12-24	2,3	No 12-28	2,3
1/4-20	2,6	1/4 - 28	2,8
5/16-18	3,3	5/16 - 24	3,5
BSW		BSF	
1/8 - 40	1,25	1/4 - 26	2,65
3/16 - 24	1,8	5/16 - 22	3,4
1/4 - 20	2,55		
5/16 - 18	3,25		

4.7. Применение инструментов с внутренними каналами для подачи охлаждающей жидкости IK/IKR

IK - Центральный охлаждающий канал - рекомендован для глухих отверстий, облегчает эвакуацию стружки в направлении к хвостовику, улучшает смазку и охлаждение, продлевает срок службы инструмента



IKR - Центральный охлаждающий канал, разделенный на несколько радиальных каналов, которые подают охлаждающую жидкость отдельно в каждую стружечную канавку. Рекомендуется для нарезания сквозных отверстий, облегчает эвакуацию стружки в направлении подачи, улучшает смазку и охлаждение, продлевает срок службы инструмента.



4.8. Классы машинных метчиков

Машинные метчики, представленные в нашем каталоге, относятся к основному классу, предназначенному для наиболее часто используемых допусков точности, соответствующих конкретным типам резьбы: для метрической резьбы 6H, для унифицированной резьбы UNC, UNF - 2B, для резьбы Витворта BSW, BSF - "нормальный". По индивидуальному запросу мы можем изготавливать метчики других классов. Классы метчиков (нп. поле допуска рабочего сегмента) для метрических резьб унифицированы по международным и национальным стандартам. Определенный класс точности резьбы включает в себя два или три поля допуска (см. рисунок и таблицу ниже.)

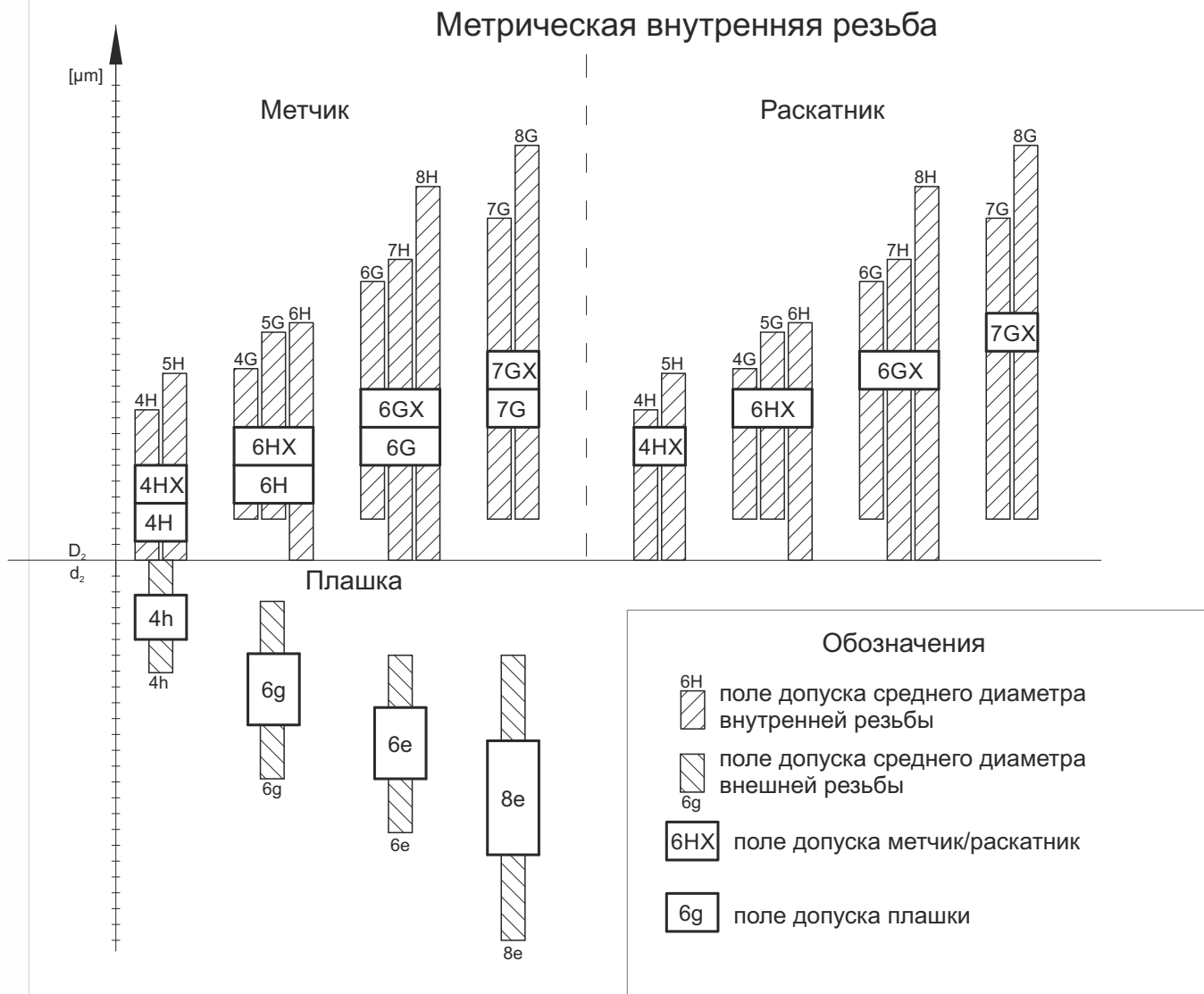

Согласно DIN 802	Поле допуска внутренней резьбы				
	4H	5H	6H	7H	8H
4H	4H	-	-	-	-
6H	4G	5G	6H	-	-
6G	-	-	6G	7H	8H
7G*	-	-	-	7G	8G

*DIN 802 предоставляет возможность коррекции допуска метчика по сравнению со стандартными требованиями в случае, когда это необходимо из-за особых условий обработки, например в зависимости от обрабатываемого материала. В такой ситуации является обязательным обозначение класса метчика символом "X", например 6HX, 6GX.

4.9. Маркировка и клеймение высокопроизводительных машинных метчиков

Маркировка

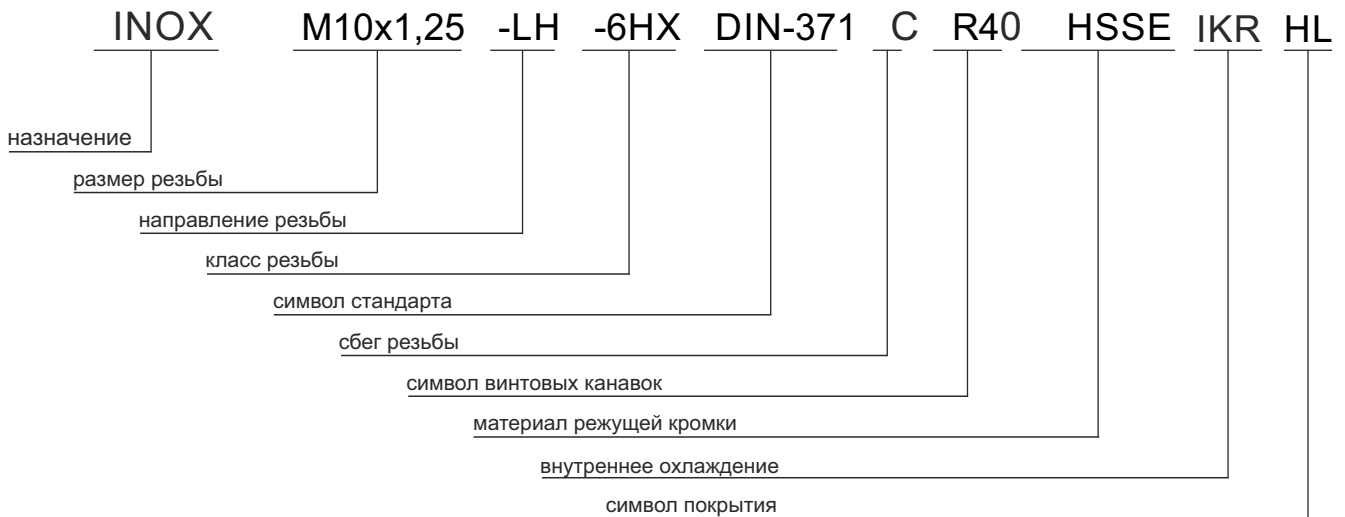

Клеймение

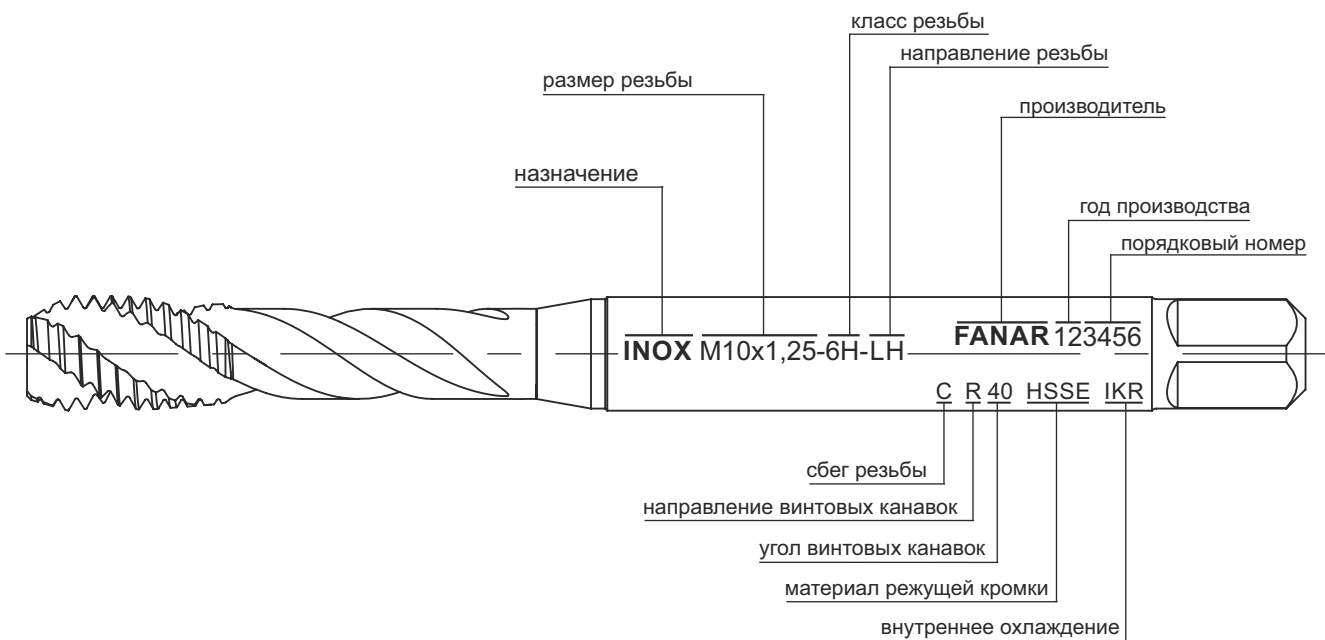

4.10. Рекомендации по обработке с помощью машинных метчиков

Нарезание резьбы обычно является одной из последних операций в процессе обработки заготовки. Ошибка в процессе нарезания резьбы может привести к дополнительным расходам, связанным не только с поврежденным метчиком, но и с материалом заготовки, а также с процессами обработки, предшествующими обработке метчиком. Чтобы избежать подобных проблем, мы советуем прочитать и применять приведенные ниже рекомендации относительно процесса нарезания резьбы.

4.11. Процесс нарезания резьбы

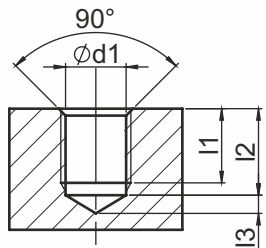
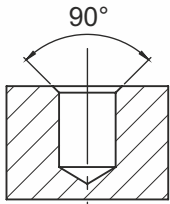
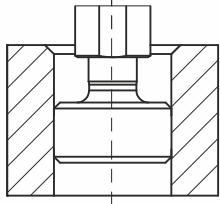
Операция		Рекомендации
10	Сверление	
 <p>$\phi d1$ - рекомендуемый диаметр сверла $l1$ - длина резьбы $l2$ - длина резьбового отверстия $l3$ - длина вершины</p>		<ul style="list-style-type: none"> - Диаметр сверла (см. главу 6, стр. 141) должен соответствовать рекомендуемому значению, представленному на странице каталога с используемым инструментом. - В случае материалов с $Rm > 1200$ МПа, диаметр отверстия должен быть как можно ближе к верхней границе допуска. - В случае глухого отверстия, чтобы достичь требуемую рабочую длину резьбы, определяя глубину отверстия, необходимо принять во внимание длину вершины сверла, длину конуса метчика (см. таблицу на стр. 231) и фаски.
20	Снятие фаски с края отверстия	
		<ul style="list-style-type: none"> - Чтобы облегчить установку метчика в отверстие и уменьшить сопротивление в начале его работы, следует снять фаску с края просверленного отверстия инструментом, с углом вершины 90° (Раздел 6, стр. 152)
30	Проверка резьбового отверстия	
		<ul style="list-style-type: none"> - При нарезании резьбы метчиком, внутренний диаметр зависит от диаметра просверленного отверстия. Правильность просверленных отверстий следует проверять при помощи гладкого калибра для резьбовых отверстий (Раздел 7, стр. 162), в соответствии с рекомендациями, включенными в технический раздел, касающийся калибров.

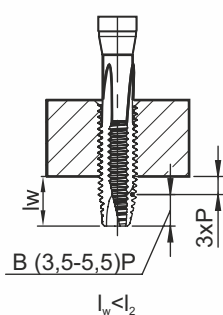
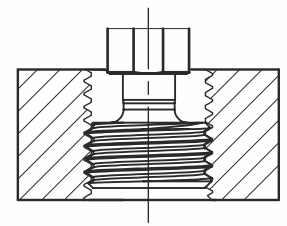
Операция		Рекомендации
40	Нарезание резьбы	<p>- При нарезании резьбы в сквозных отверстия метчиком со спиральной подточкой, следует уделить особое внимание выходу метчика из отверстия. Для правильном нарезании резьбы и эвакуации стружки, метчик должен выйти из отверстия на всю длину спиральной подточки + примерно 3 шага резьбы.</p>
		<p>- При нарезании резьбы в глухих отверстиях, не должно происходить столкновения между поверхностью метчика и дном отверстия.</p> <p>- В случае станков с ЧПУ с циклом синхронного нарезания резьбы, рекомендуется использовать патрон с минимальной осевой компенсацией (Раздел 8, стр. 179)</p> <p>- При выборе скоростей обработки следует учитывать то как заготовка и метчик были закреплены, тип обрабатываемого материала, тип и состояние станка, а также условия смазки метчика.</p>
50	Проверка резьбы	<p>- После завершения нарезания резьбы, ее следует проверить при помощи резьбового калибра (Раздел 7, стр. 164), в соответствии с рекомендациями, включенными в технический раздел, касающийся калибров.</p>
		

4.11. Решение проблем, связанных с нарезанием резьбы

Проблема: увеличенный размер резьбового отверстия (Непроходной калибр двигается легко)

Вы использовали метчик неподходящий для данного материала или вида резьбы.	Используйте подходящий метчик в соответствии с таблицей в каталоге
Скорость нарезания была слишком высокой	Снизьте скорость резания Используйте больше охлаждающей жидкости / смазки
На поверхности метчика образовались приваривания	Замените инструмент на новый Используйте метчик с покрытием Используйте больше охлаждающей жидкости / смазки Удалите поврежденные зубья
Произошло засорение стружечных канавок	Используйте метчик с другой геометрией канавок
Образовался заусенец	Удалите его с помощью специальной щетки
Неправильная фиксация метчика	Используйте патроны с осевой и параллельной компенсацией Попробуйте точно закрепить обрабатываемый элемент
Неравномерная подача метчика	Контролируйте подачу метчика во время нарезания резьбы Проверьте параметры программы станка с ЧПУ Проверьте ходовой винт на люфт Используйте патроны с компенсацией

Проблема: увеличенный размер резьбового отверстия (двигается непроходной калибр)

Допуск использованного метчика был слишком большим по сравнению с требуемым классом резьбы	Проверьте маркировку метчика и убедитесь, что он подходит для нарезания требуемого класса резьбы Если у вас возникнут какие-либо проблемы, свяжитесь с нашим техническим представителем
Неправильное восстановление метчика	При восстановлении метчика требуется чтобы все поверхности сохранили свою изначальную геометрию, заданную производителем Для получения дополнительной информации свяжитесь с нашим представителем

Проблема: уменьшенный размер резьбового отверстия (не входит проходной калибр)

Выбранный метчик имеет геометрию неподходящую для нескольких повторов	Попробуйте ограничить число повторов Используйте другой метчик
Часть метчика не была обновлена во время перезаточки	Попробуйте заточить метчик еще раз Используйте новый метчик
Вы использовали неподходящий метчик для данного типа резьбы или обрабатываемого материала	Используйте метчик, подходящий для данного типа резьбы и материала в соответствии с таблицей в каталоге
Используемый метчик имеет слишком малый номинальный размер (допуск)	Проверьте маркировку метчика и убедитесь, что он подходит для требуемого класса резьбы В случае каких-либо проблем, свяжитесь с нашим представителем

Проблема: первые несколько витков резьбы увеличенного размера

Допуск метчика был слишком большим по сравнению с требуемым классом резьбы	Проверьте маркировку метчика и убедитесь, что он подходит для требуемого класса резьбы В случае каких-либо проблем, свяжитесь с нашим представителем
Неправильное восстановление метчика	При восстановлении метчика требуется чтобы все поверхности сохранили свою изначальную геометрию, заданную производителем Для получения дополнительной информации свяжитесь с нашим представителем

Проблема: короткий срок службы метчика

Все причины, указанные в следующей таблице «рваные и неровные резьбы»	Прочитайте таблицу «рваные и неровные резьбы»
Метчик потерял свою твердость из-за избыточного нагрева при восстановлении	Измените параметры шлифовального круга При шлифовании используйте хладагент
Потеря поверхностной обработки во время перезаточки	Повторно обработайте поверхность метчика Убедитесь, что тип поверхностной обработки подходит для данного обрабатываемого материала
Затвердевание отверстия и фаски во время просверливания	Чаще меняйте или затачивайте сверло Убедитесь, что правильно подобраны скорость и подача при сверлении Отожгите деталь перед нарезанием резьбы

Проблема: повреждение режущей части	
Вы использовали неподходящий метчик для данного типа резьбы или материала	Используйте подходящий метчик в соответствии с таблицей из каталога
Размер сверла был меньше требуемого	Используйте сверло правильного размера - определите подходящий размер по каталогу (обратите внимание, что для метчиков и раскатников эти значения различаются) В случае проблем, свяжитесь с нашим представителем
Резбовое отверстие было недостаточно глубоким	Проверьте фактическую глубину сверла (сверло могло сдвинуться вглубь патрона)
Отсутствие резьбового отверстия	Убедитесь в наличии резьбового отверстия (это проблема встречается на производственных линиях с использованием нескольких шпинделей)
Произошло засорение стружечных канавок	Попробуйте использовать метчик с другой геометрией (углом) канавок Может потребоваться использование набора метчиков
На поверхности метчика образовались приваривания	Замените инструмент на новый Используйте метчик с покрытием Используйте больше охлаждающей жидкости / смазки Удалите поврежденные зубья
Произошла перегрузка зубьев фаски	Используйте метчик с более длинной фаской Используйте метчик с увеличенным количеством канавок, это обеспечит более скошенные зубья
Неправильное положение или фиксация детали	Используйте патроны с осевой и параллельной компенсацией Попробуйте лучше закрепить обрабатываемую деталь
Произошло столкновение метчика с дном резьбового отверстия	Используйте патроны с компенсацией длины и с системой перегрузки крутящего момента
Нарезание резьбы в твердых или высокопрочных материалах	Убедитесь, что метчик подобран правильно Возможно лучше подойдут высокопроизводительные метчики HSSE-PM и VHM, чем метчики HSSE
Проблема: Рваные и неровные резьбы	
Вы использовали неподходящий метчик для данного типа резьбы или материала	Используйте метчик, подходящий для данного типа резьбы и материала - в соответствии с таблицей в каталоге
Скорость нарезания была слишком высокой или слишком низкой	Подберите подходящую скорость Обратите внимание на выбор охлаждающей жидкости
На поверхности метчика образовались приваривания	Замените инструмент на новый Используйте метчик с покрытием Используйте больше охлаждающей жидкости / смазки Удалите поврежденные зубья
Произошло засорение канавок	Попробуйте использовать метчик с другой геометрией (углом) канавок Может потребоваться использование набора метчиков
Образовался заусенец	Удалите его с помощью специальной щетки
Размер сверла был слишком мал	Используйте сверло правильного размера - определите подходящий размер по каталогу (обратите внимание, что для метчиков и раскатников эти значения различаются) В случае проблем, свяжитесь с нашим представителем
Недостаточное охлаждение или смазка во время нарезания резьбы	Выберите подходящую смазку в соответствии с примечаниями из каталога Используйте достаточное количество охлаждающей жидкости / смазки
Произошла перегрузка инструмента из-за грубой подачи, слишком твердого материала или коротких фасок	Может потребоваться использование набора метчиков

4.12. Восстановление - информация касательно переднего угла

Группа материалов	Материал	Обозначение	γ_p [°]
P	Сталь	800	10 – 13
		FAN-1200	7 – 10
		1400	5 – 7
M	Нержавеющая сталь	INOX	10 – 13
K	Чугун	GG	4 – 6
N	Цветные материалы	GAL	7 – 9
			10 – 13
			4 – 6
S	термостойкие сплавы, титановые сплавы	1400	5 – 7
H	Твердые материалы	HRC50	-5 – -4

5. Раскатники

5.1. Конструктивные элементы раскатника

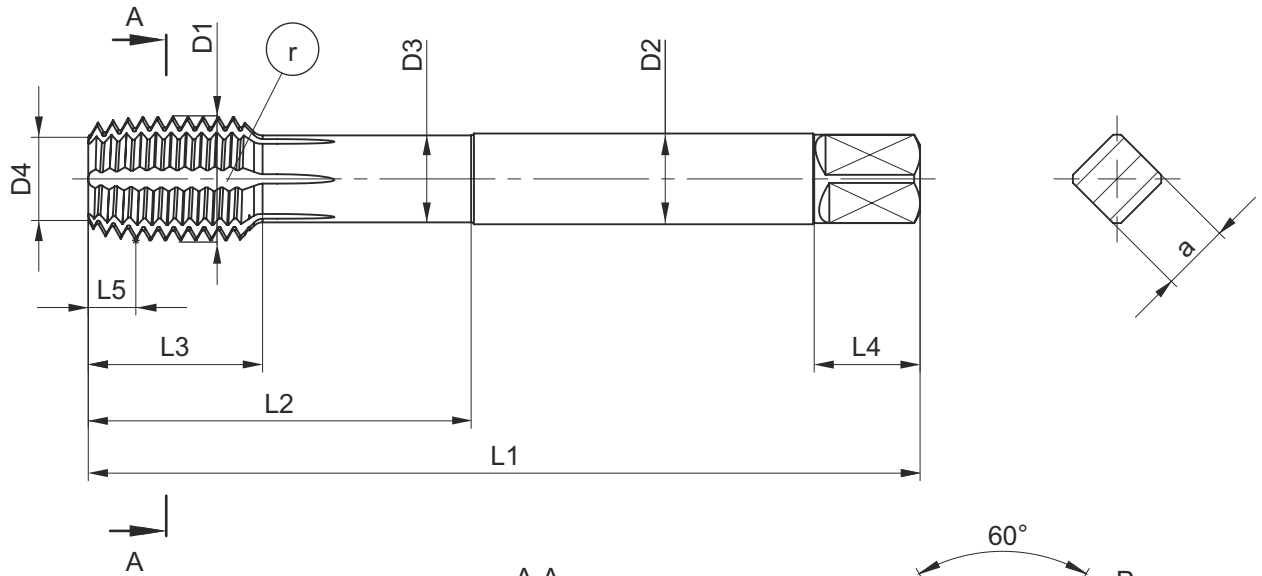

- L1- общая длина
- L2 - длина резьбы
- L3 - длина рабочей части
- L4 - длина квадрата
- L5 - длина сбега резьбы
- $\varnothing D1$ - диаметр резьбы
- $\varnothing D2$ - диаметр хвостовика
- $\varnothing D3$ - диаметр шейки
- $\varnothing D4$ - диаметр сбега
- $\varnothing D5$ - диаметр стержня

- r - прямая канавка
- k - угол сбега резьбы
- α - угол резьбы
- P - шаг резьбы
- m - ширина пера
- a - размер квадрата

5.2. Типы сбега резьбы раскатников

Символ	Схема	Длина сбега, измеряемая количеством витков резьбы	Угол
C		$2 \div 3 P$	$8,5^\circ$
E		$1,5 \div 2 P$	$11,5^\circ$

5.3. Маркировка и клеймение раскатчиков

Маркировка

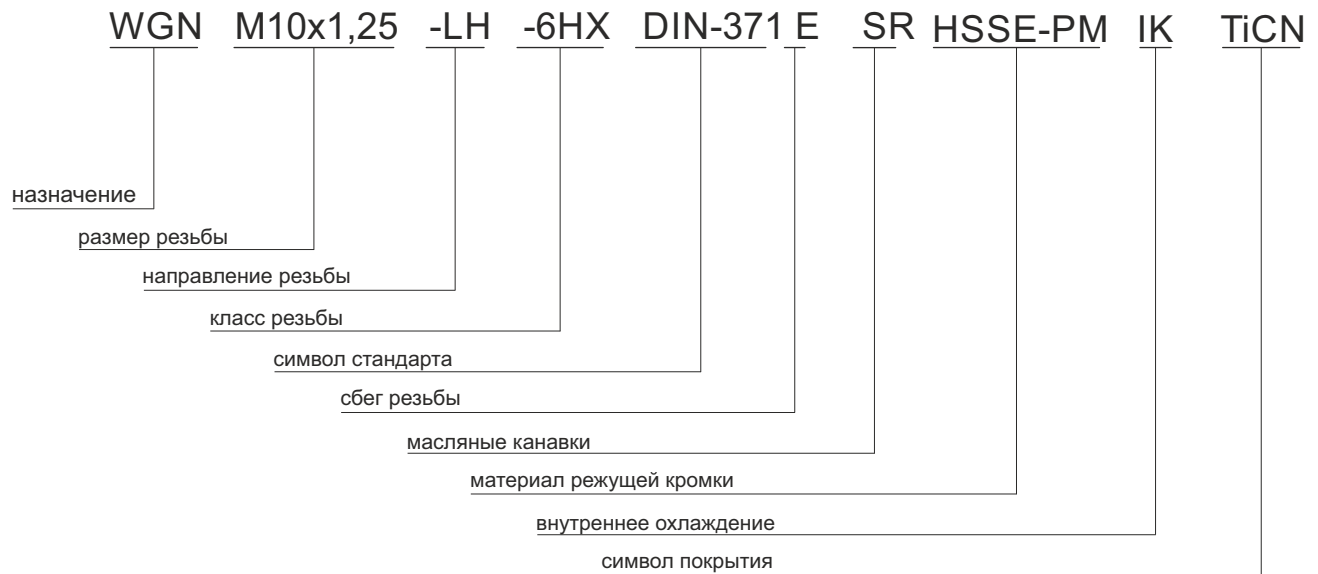

Клеймение

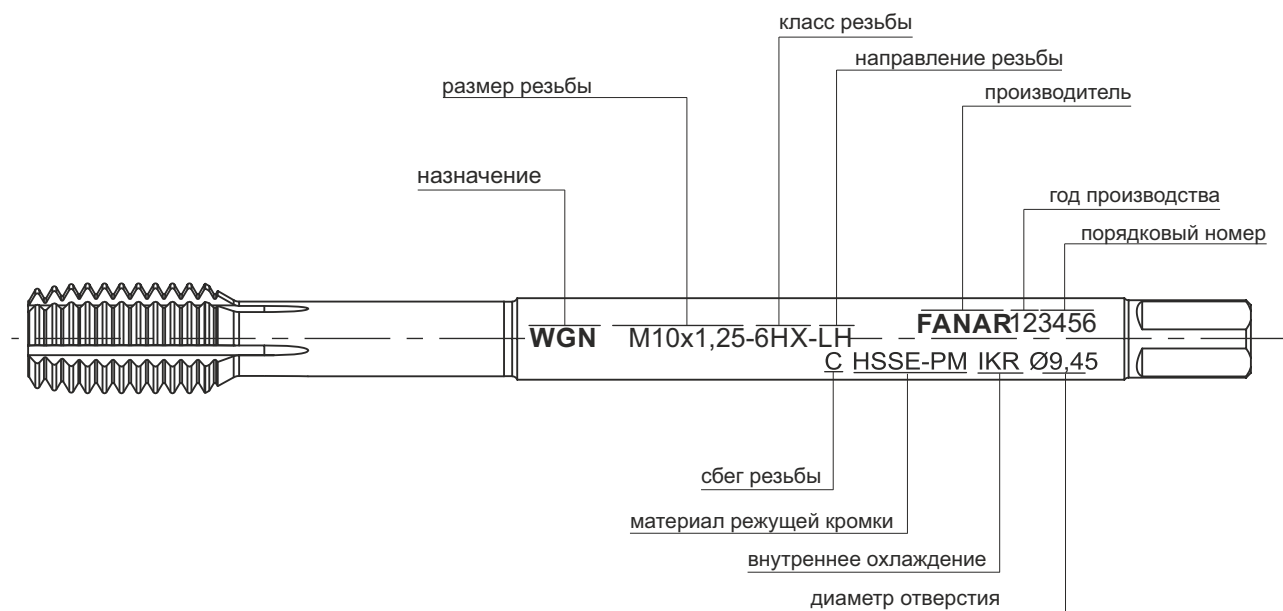

5.4. Разница между нарезанием и формированием резьбы

Формирование резьбы является бесстружечным методом обработки, при котором резьба образуется за счет пластической деформации, без необходимости эвакуации стружки. Материал остается холодным и целостность его волокон не нарушается.





Нарезание резьбы



Формирование резьбы

Преимущества формирования резьбы	Недостатки формирования резьбы
<ul style="list-style-type: none"> → отсутствие стружки → один инструмент как для сквозных, так и для глухих отверстий → возможность обработки глубоких отверстий (4xD) → высокая прочность резьбы, особенно на боковых поверхностях шага резьбы → более гладкая поверхность резьбы → отсутствие ошибок в форме и шаге резьбы → возможность использовать значительно более высокие параметры обработки, поскольку производительность обработки большинства материалов увеличивается со скоростью, она не оказывает негативного влияния на срок службы инструмента → высокая жесткость инструмента снижает риск его повреждения 	<ul style="list-style-type: none"> → крутящий момент гораздо выше чем при нарезании → неполное формирование вершины резьбы → грузоподъемность такой резьбы составляет около 80% от грузоподъемности нарезанной резьбы, хотя прочность выше → диапазон применения ограничен пластичными материалами → большой допуск резьбы → не рекомендуется использовать данный метод в пищевой и фармацевтической промышленности

5.5. Решение проблем связанных с формированием резьбы

Проблема	Решение
<p data-bbox="172 302 507 331">Неполная форма резьбы</p> 	<p data-bbox="831 398 1378 526">Используйте сверло меньшего диаметра либо подберите диаметр сверла согласно таблицы выбора для метчиков-раскатников на странице 270</p>
<p data-bbox="172 784 1118 813">Преувеличенная форма резьбы, слишком малый внутренний диаметр</p> 	<p data-bbox="831 880 1410 1008">Используйте сверло большего диаметра либо подберите диаметр сверла согласно таблицы выбора для метчиков-раскатников на странице 270</p>
<p data-bbox="172 1265 1310 1294">Низкое качество поверхности резьбы, вырывание материала с поверхности резьбы</p>	<ul data-bbox="831 1328 1342 1545" style="list-style-type: none"> - Необходимо улучшить условия смазки: используйте раскатники с масляными канавками - Увеличьте количество охлаждающей жидкости / смазки - Используйте масло в качестве смазки - Используйте раскатники с покрытием
<p data-bbox="172 1579 467 1608">Поломка инструмента</p> 	<ul data-bbox="831 1635 1369 1883" style="list-style-type: none"> - Увеличьте диаметр резьбового отверстия - Увеличенное количество охлаждающей жидкости / смазки - Нанесите покрытие, предотвращающее прилипание обрабатываемого материала - Проверить соответствие заготовки рекомендациям относительно ее пластичности и твердости

6. ПЛАШКИ

6.1. Конструктивные элементы плашек

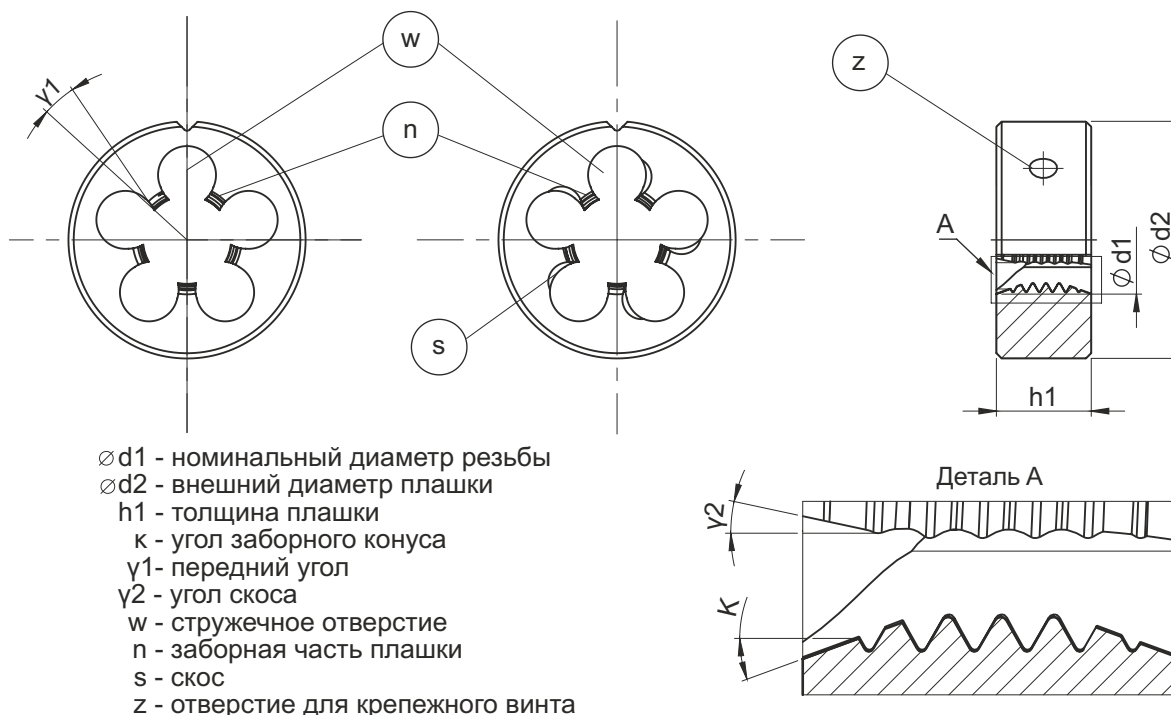

6.2. Стандарты измерений

Стандарты измерений определяют серии наружных размеров плашек (диаметр, толщина) которые присваиваются номинальным стандартам, а также измерения, связанные с креплением плашки в держателе (положение, размер отверстий для крепежных винтов и V-образных пазов).

Символ	Стандарты	Назначение
DIN	EN 22 568 (бывший DIN 223) PN-92/M-58070 ISO 2568	Круглые плашки для метрической грубой M и мелкой MF резьбы, UNC, UNF, BSW, BSF а также других типов резьбы, за исключением трубной резьбы G и R
DIN	EN 24 231 (бывший DIN 5158) PN-92/M-58161 ISO 4231	Круглые плашки для трубной резьбы G
DIN	EN 24 230 (бывший DIN 5159) PN-92/M-58160 ISO 4230	Круглые плашки для трубной конической резьбы R

6.3. Маркировка и клеймение плашек

Маркировка

Пример: высокопроизводительная машинная плашка по DIN-EN 22 568 для резьбы M12, с допуском резьбы 6g, для нержавеющей стали

Маркировка: указывается в заказах, инвойсах, спецификации, на упаковке



Клеймение

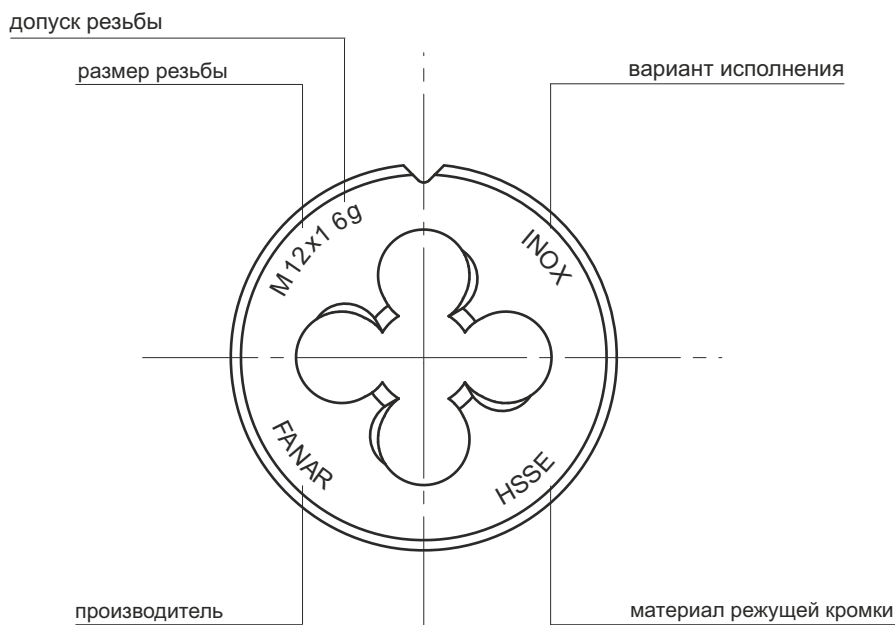

6.4. Допуски нарезанной резьбы

Плашки, представленные в нашем каталоге предназначены для нарезания резьбы с наиболее распространенными и основными допусками для данного типа резьбы: для метрической резьбы 6g, для резьб UNC, UNF, и т.д., 2A. На заказ мы можем изготовить плашки для резьбы с другим допуском, например, для метрических резьб: 4h для плотной резьбы, 6e для резьбы под тонкое гальваническое покрытие.

6.5. Группы инструментов по применению

<p>800</p> <p>P N</p>	Для обработки конструкционной стали и литой стали с $R_m \leq 800$ МПа
<p>800</p> <p>SPN</p> <p>P N</p>	Для обработки конструкционной стали и литой стали с $R_m \leq 800$ МПа. Лучшее качество полученной резьбы, для использования на автоматических токарных станках.
<p>Ms</p> <p>N</p>	Для обработки латуни и бронзы, дающей короткую стружку
<p>INOX</p> <p>P M K N</p>	Для обработки нержавеющей стали, литого алюминия и высокопрочного чугуна

6.6. Заборная часть плашки

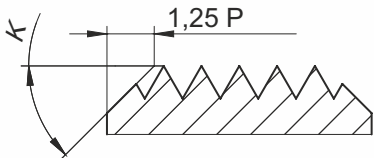
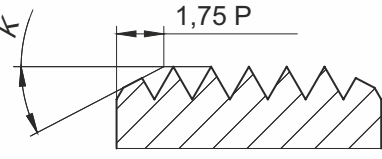
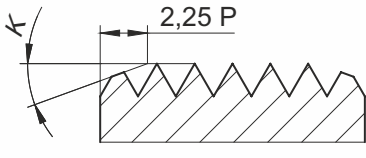
Длина заборной части	Применение	Схема	К - Угол заборного конуса
1,25 P	Ms		45°
1,75 P	800		27,5°
2,25 P	INOX		20°

7. КАЛИБРЫ

7.1. Конструктивные элементы калибра

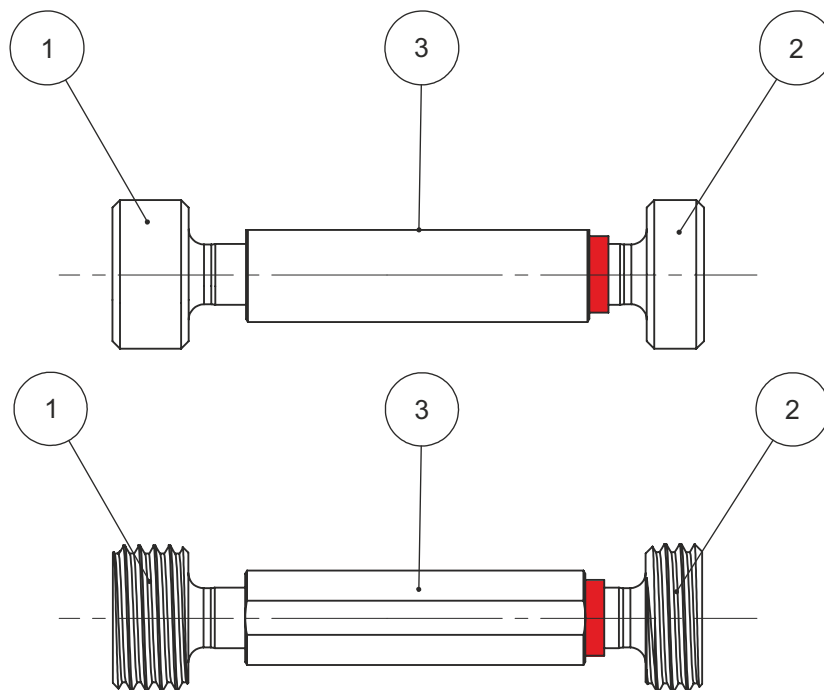

- 1 - проходной калибр-пробка
- 2 - непроходной калибр-пробка
- 3 - рукоятка

7.2. Типы калибров

7.2.1 Калибры NPT

Выравнивание на уровне
плоскости заготовки

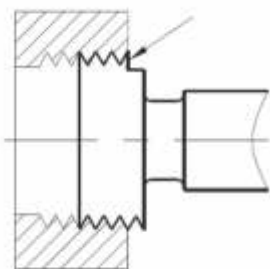

Базовая глубина

Выравнивание на один оборот
выше плоскости заготовки

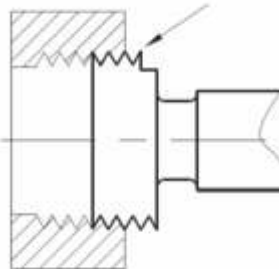

Минимальная глубина

Выравнивание на один оборот
ниже плоскости заготовки

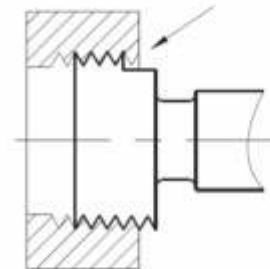





Максимальная глубина

Трубные резьбы, герметичные соединения на резьбе были выполнены по PN-EN 10226-1, PN-EN 10226-2 (ISO7-1:2000).

Проверка при помощи предельных калибров по PN-EN 10226-3 (ISO-7-2:2000)

7.2.2 Калибры R, Rc/Rp

<p>Калибр № 1</p> 	<p>Конический резьбовой калибр-пробка 1:16 конический калибр-пробка с полной резьбой подходит для проверки наружного диаметра (D) и среднего диаметра (D2) в калибровочной плоскости внутренней цилиндрической (Rp) и внутренней конической (Rc) резьбы.</p>
<p>Калибр № 2</p> 	<p>Конический резьбовой калибр-пробка с пропуском Данный 1:16 конический калибр-пробка имеет перерыв в резьбе и подходит для проверки внешнего диаметра (D), среднего диаметра (D2) в калибровочной плоскости, и аккомодационной длины¹ внутренней цилиндрической (Rp) и внутренней конической (Rc) резьбы.</p> <p><small>¹Аккомодационная длина: расстояние от поверхности детали с внутренней резьбой до первого препятствия которое встретит деталь с внешней резьбой при сборке.</small></p>
<p>Калибр № 3</p> 	<p>Цилиндрический резьбовой калибр-кольцо Цилиндрический резьбовой калибр-кольцо подходит для проверки внутреннего диаметра (d1) и среднего диаметра (d2) в калибровочной плоскости конической внешней резьбы (R).</p>
<p>Калибр № 4</p> 	<p>Конический гладкий калибр-кольцо 1:16 конический гладкий калибр-кольцо подходит для проверки внешнего диаметра (d) и соответствующей полезной длины внешней конической резьбы (R).</p>
<p>Калибр № 5</p> 	<p>Контрольный конический резьбовой калибр-пробка Данный контрольный калибр-пробка предназначен для проверки размеров цилиндрического резьбового калибра-кольца (калибра №3) при его производстве либо для проверки его на износ.</p>

7.3. Проверка отверстий

Для проверки сквозных и глухих отверстий используются проходные и непроходные калибры. Проходной калибр должен войти в отверстие под действием собственного веса либо при легком нажатии. Нельзя слишком сильно давить на калибр, так как он может застрять в отверстии. Непроходной калибр должно быть невозможно вставить в отверстие.

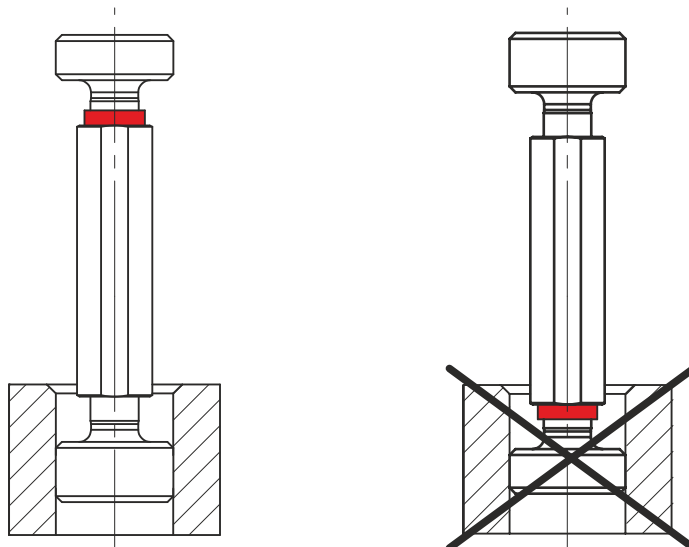

Проверка внутренней цилиндрической резьбы

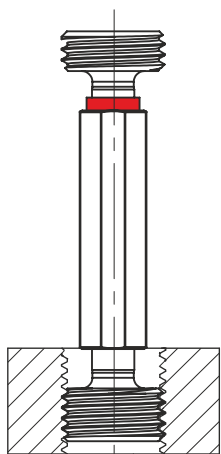

Для проверки внутренних резьб используются проходные и непроходные резьбовые калибры. При помощи **проходного резьбового калибра** определяется нижнее значение среднего диаметра и таким образом проверяется виртуальный внутренний размер резьбы. При ввинчивании вручную, проходной калибр должен без особых усилий войти на всю глубину резьбы. Резьба не отвечает требованиям, если является невозможным ввинтить в нее калибр.

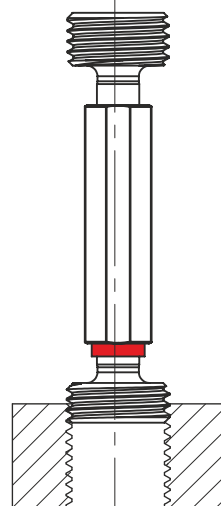

При помощи **непроходного резьбового калибра** определяется не выходит ли средний диаметр резьбы за верхнюю границу допустимых значений. При ввинчивании вручную непроходной калибр должен без усилий войти на глубину **не превышающую 2 витка** резьбы. Если калибр вкручивается глубже, чем 2 витка, это означает, что резьба не соответствует требованиям.

7.4. Использование калибров и проверка резьбы

Проверка внутренней конической (Rc) и внутренней цилиндрической (Rp) резьб

Этап 1: Конический резьбовой калибр-пробка (калибр №1) завинчивается вручную во внутреннюю резьбу. Внутренняя резьба имеет допустимый допуск если торцевая поверхность заготовки находится в границах контрольных плоскостей калибра, либо совпадает с одной из них.

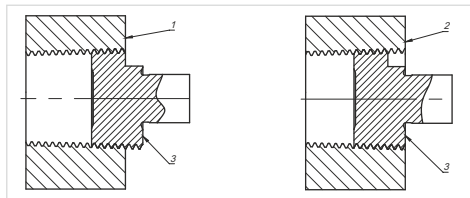

Обозначения

- 1 - торцевая поверхность заготовки совпадает с первой контрольной плоскостью калибра
- 2 - торцевая поверхность заготовки совпадает со второй контрольной плоскостью калибра
- 3 - калибр №1

Этап 2: Конический резьбовой калибр-пробка с пропуском (калибр №2) завинчивается вручную во внутреннюю резьбу. Внутренняя резьба имеет допустимый допуск если торцевая поверхность заготовки находится в границах контрольных плоскостей калибра, либо совпадает с одной из них.

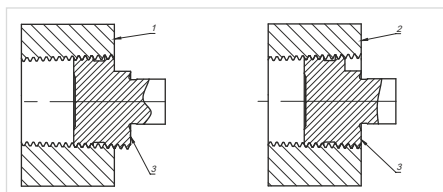

Обозначения

- 1 - торцевая поверхность заготовки совпадает с первой контрольной плоскостью калибра
- 2 - торцевая поверхность заготовки совпадает со второй контрольной плоскостью калибра
- 3 - калибр №2

Примечание 1: Если заготовка отвергается калибром №1, но принимается калибром №2, это может указывать на отсутствие аккомодационной длины.

Примечание 2: Отклонение в относительном положении контрольных плоскостей калибров №1 и №2 более чем $0,5P$, но менее чем $1P$ является допустимым если производитель и покупатель договариваются, что во время сборки будет использован герметик резьбы, и это скомпенсирует преувеличенную разницу в результатах калибров.

Примечание 3: В случае резьб Rp, если глубина фаски в среднем диаметре резьбы составляет больше или меньше, чем $0,5P$, то это может в небольшой мере повлиять на результаты измерения калибрами.

Проверка внешней конической резьбы (R)

Этап 1: Резьбовой калибр-кольцо (калибр №3) навинчивается вручную на наружную резьбу. Наружная резьба имеет допустимый допуск если торцевая поверхность заготовки находится в границах контрольных плоскостей калибра, либо совпадает с одной из них.

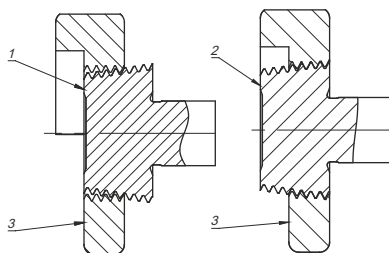

Обозначения

- 1 - торцевая поверхность заготовки совпадает с первой контрольной плоскостью калибра
- 2 - торцевая поверхность заготовки совпадает со второй контрольной плоскостью калибра
- 3 - калибр №3

Этап 2: Конический гладкий калибр-кольцо (калибр №4) навинчивается вручную на наружную резьбу. Наружная резьба имеет допустимый допуск если торцевая поверхность заготовки находится в границах контрольных плоскостей калибра, либо совпадает с одной из них, а основания всех витков резьбы, находящихся под калибром полностью оформлены.

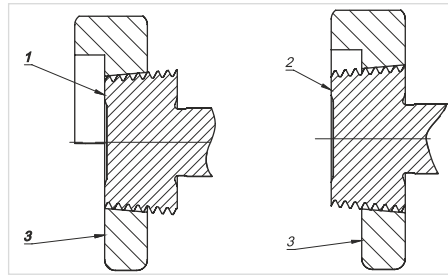

Обозначения

- 1 - торцевая поверхность заготовки совпадает с первой контрольной плоскостью калибра
- 2 - торцевая поверхность заготовки совпадает со второй контрольной плоскостью калибра
- 3 - калибр №4

Примечание: Отклонение в относительном положении контрольных плоскостей калибров №3 и №4 более чем $0,5 R$, но менее чем $1R$ является допустимым если производитель и покупатель договариваются, что во время сборки будет использован герметик резьбы, и это скомпенсирует, преувеличенную разницу в результатах калибров.

Проверка конического калибра-пробки на износ (калибры №1 и №2)

Средний диаметр резьбового калибра-пробки можно проверить при помощи регулируемого калибра-кольца (калибр №6). Внешний диаметр конического резьбового калибра-пробки проверяется прямым измерением.

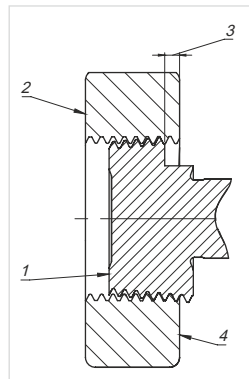

Обозначения

- 1 - калибры №1 и №2
- 2 - калибры №6
- 3 - расстояние между контрольной плоскостью калибра-пробки и торцевой поверхностью калибра-кольца - l_{13} (см. PN-EN 10226-3:2005 таблица 16)
- 4 - эта поверхность помечена чтобы обозначить калибровочную плоскость

Проверка цилиндрического калибра-кольца на износ (калибр №3)

Средний диаметр резьбового калибра-кольца проверяется коническим регулируемым калибром-пробкой. Внутренний диаметр проверяется прямым измерением

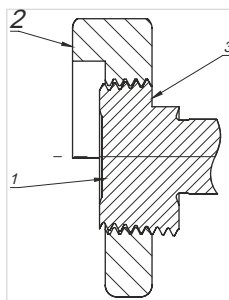

Обозначения

- 1 - калибры №5
- 2 - калибры №3
- 3 - расстояние между контрольной плоскостью калибра-пробки и торцевой поверхностью калибра-кольца - l_{14} (см. PN-EN 10226-3:2005 таблица 16)
- 4 - эта поверхность помечена чтобы обозначить калибровочную плоскость

8. Спиральные сверла

8.1. Конструктивные элементы сверла

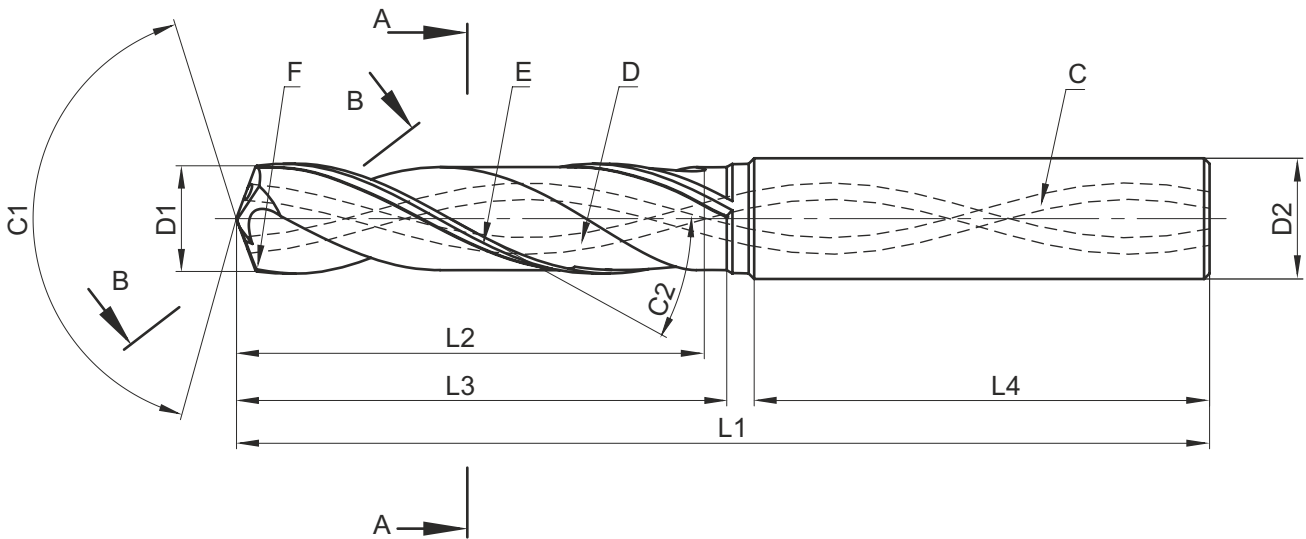

- C - канал подачи охлаждающей жидкости
- D - стружечная канавка
- E - ленточка (спиральная фаска)
- F - передняя поверхность
- G - главная режущая кромка
- H - вспомогательная режущая кромка
- I - спинка пера
- J - поперечная кромка

без сужения
центральной зоны

с сужением
центральной зоны

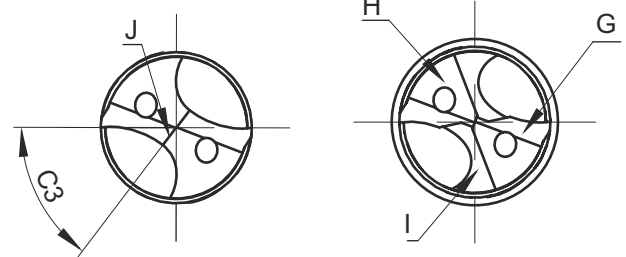

- L1 - общая длина
- L2 - длина стружечных канавок
- L3 - запасная длина
- L4 - длина хвостовика
- D1 - диаметр рабочей части
- D2 - диаметр хвостовика
- D3 - диаметр сердцевины
- D4 - расстояние между каналами подачи хладагента
- D5 - диаметр каналов подачи хладагента
- C1 - угол при вершине
- C2 - угол наклона винтовой канавки
- C3 - угол наклона поперечной режущей кромки
- C4 - задний угол
- C5 - угол главной режущей кромки
- C6 - угол вспомогательной режущей кромки
- G1 - толщина ленточки (спиральной фаски)
- G2 - высота ленточки (спиральной фаски)
- B - ширина пера

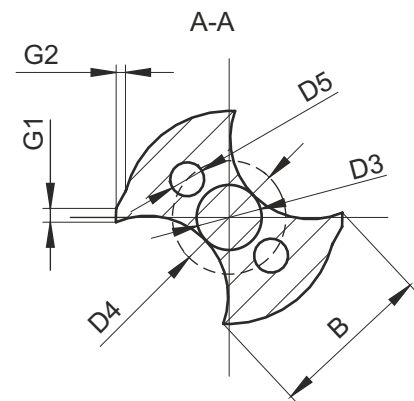

B-B

Типы геометрии задней поверхности сверла

Четырехповерхностная

Коническая (эксцентрическая)

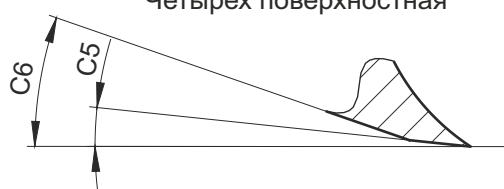

8.2. Условия охлаждения и смазки

Применение охлаждающей жидкости:

- Рекомендуется использовать охлаждающую жидкость, если глубина сверления по меньшей мере вдвое превышает диаметр.
- Применение охлаждающей жидкости является обязательным при глубине в пять раз превышающей диаметр сверла.
- При применении внешнего охлаждения охлаждающую жидкость следует подавать не только с соответствующим давлением, но и соответствующим методом.

Методы подачи охлаждающей жидкости:

Внутренний:

- Рекомендован всегда, когда глубина отверстия по меньшей мере втрое превышает диаметр.
- Внутреннее охлаждение помогает избежать закупорки стружечных канавок.

Внешний:

- Чтобы улучшить эвакуацию стружки, по крайней мере одно отверстие для хладагента (два, если сверло зафиксировано) должны быть направлены близко к оси инструмента.
- Внешнее охлаждение помогает избежать образования наростов на краях благодаря обнижению температуры краев.
- Внешнее охлаждение допускается для материалов, дающих короткую стружку.

8.3. Поиск и устранение проблем

Проблема: Наросты на краях	
Слишком низкая скорость сверления	Увеличьте скорость сверления
Слишком высокая температура на краях инструмента	Используйте хладагент
Слишком большой отрицательный передний угол	Заточите режущие кромки
Износ покрытия	Восстановите покрытие
Низкое содержание масла в охлаждающей жидкости	Увеличьте количество масла в хладагенте
Проблема: Откалывание углов	
Чрезмерное биение	Используйте патрон с более точной фиксацией
Чрезмерная подача	Уменьшите подачу
Недостаточное количество хладагента	Проверьте давление охлаждающей жидкости
Низкая жесткость системы удерживания инструмента	Проверьте жесткость фиксации инструмента в патроне

Проблема: Чрезмерный износ режущей кромки	
Чрезмерное биение	Используйте патрон с более точной фиксацией
Чрезмерная подача	Уменьшите подачу
Прерывистый процесс резки	Проверьте давление охлаждающей жидкости
Низкая жесткость системы удерживания инструмента	Проверьте жесткость фиксации инструмента в патроне
Проблема: Сколы на режущей кромке	
Чрезмерное биение	Используйте патрон с более точной фиксацией
Нестабильные условия резания	Проверьте параметры резания
Критический износ инструмента	Меняйте инструмент чаще
Слишком твердый материал	Выберите инструмент подходящий для данного материала
Проблема: Изнашивание зубьев	
Чрезмерное биение	Используйте патрон с более точной фиксацией
Низкое давление охлаждающей жидкости	Используйте чистое масло или эмульсию с высоким содержанием масла
Слишком высокая скорость резания	Уменьшите скорость резания
Наросты образованные материалом заготовки	Выберите инструмент подходящий для данного материала
Проблема: Износ поперечной режущей кромки	
Слишком низкая скорость резания	Увеличьте скорость резания
Чрезмерная подача	Уменьшите подачу
Слишком маленькая поперечная режущая кромка	Убедитесь, что выбран подходящий размер инструмента
Проблема: Пластическая деформация	
Слишком высокая скорость резания	Уменьшите скорость резания
Чрезмерная подача	Уменьшите подачу
Плохая подача охлаждающей жидкости	Проверьте давление охлаждающей жидкости и отверстия для ее подачи
Низкая жесткость системы удерживания инструмента	Используйте сверло VHM
Проблема: Истирание покрытия от края	
Слишком большое трение	Используйте хладагент с большим количеством масла или добавок
Извлечение под углом	Уменьшите скорость подачи при извлечении
Наросты образованные материалом заготовки	Уменьшите число восстановлений инструмента
Проблема: Застревание стружки	
Слишком низкая скорость резания	Увеличьте скорость резания
Чрезмерная подача	Уменьшите подачу
Слишком маленькие стружечные канавки	Выберите инструмент с правильной геометрией
Плохой отвод стружки	Используйте внутреннее охлаждение

9. ПАТРОНЫ ДЛЯ МЕТЧИКОВ

9.1. Патроны „SOFT SYNCHRO” для метчиков

MASTERSYNC

Принцип действия

В основе патронов MasterSYNC лежит точно выполненный гибкий элемент, который обеспечивает осевую и радиальную компенсацию неизбежного несоответствия между шагом метчика и реальной подачей. Благодаря компенсации такой погрешности, силы, действующие на метчик, значительно уменьшаются. В результате достигается максимально возможный срок службы метчика, а также очень высокое качество полученной резьбы.

Уникальный гибкий элемент

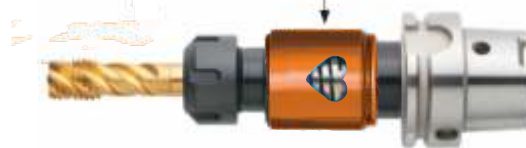

В патронах MasterSYNC имеется специальная система ограничителей, которая используется как для регулирования перемещений при осевой компенсации, так и для регулирования сил кручения, которые передаются на гибкий элемент.

Осевая микро компенсация со специальной системой механических ограничителей

Крутящий момент передается через приводные штифты - не через гибкий элемент

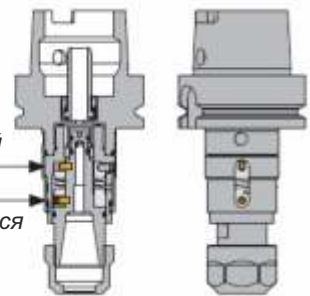

Внутреннее охлаждение под высоким давлением и MQL (минимальное количество смазки)

Внутреннее охлаждение под высоким давлением можно использовать при давлении до 80 бар без влияния на осевую компенсацию. В ассортименте Fanar представлены инструменты для системы MQL через шпиндель. Наша система обеспечивает прямой поток воздуха и смазки к задней части метчика.

IK

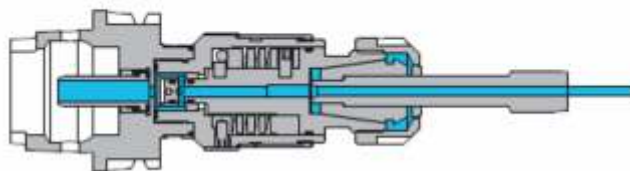

Внутреннее охлаждение под высоким давлением с увеличенной скоростью потока

MQL

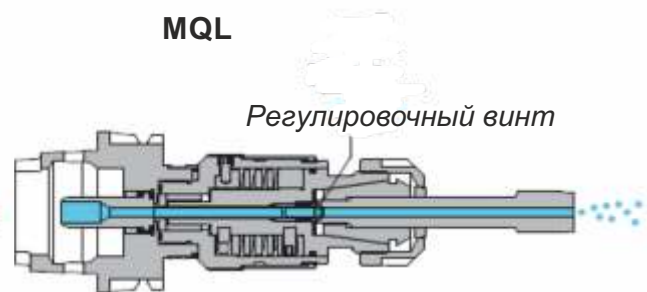

Система MQL доступна для одноканальных и многоканальных систем

Регулировочный винт

9.2. Быстросменные адаптеры для метчиков с предохранительной муфтой

РЕКОМЕНДУЕМЫЕ ЗНАЧЕНИЯ КРУТЯЩЕГО МОМЕНТА ДЛЯ РЕЗЬБОВЫХ МАТЕРИАЛОВ С $RM = 1000 MPa$

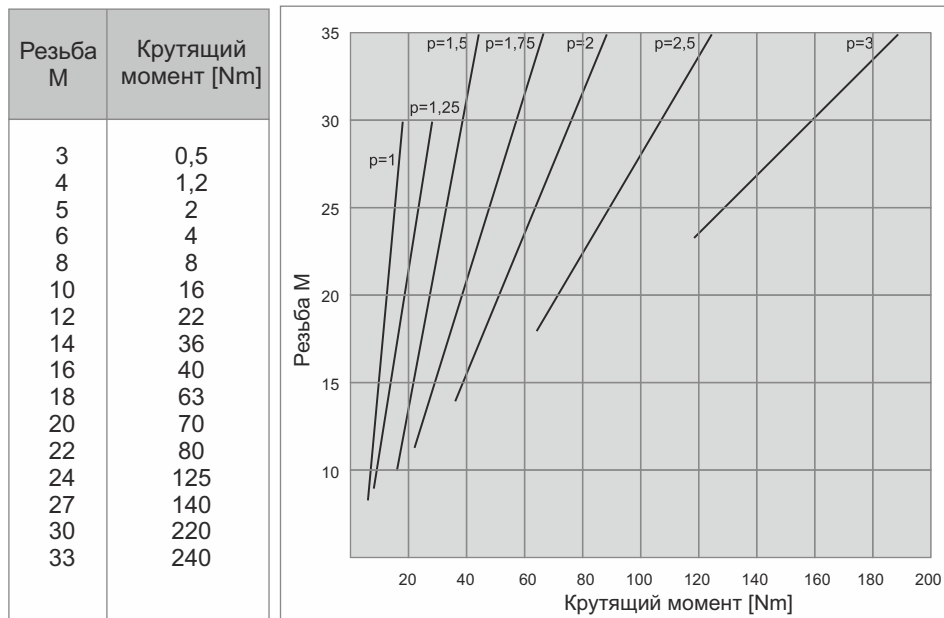

Указанные значения являются приблизительными и могут отличаться в зависимости от конкретных условий эксплуатации

9.3. Цанги типа ER

СТЕРЖЕНЬ ХВОСТОВИКА ЗАКРЕПЛЕН В ЦАНГЕ ТИПА ER

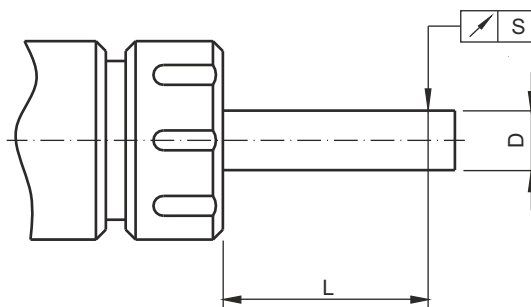

D	L	S
1-1,6	6	0,015
1,6-3	10	0,015
3-6	16	0,015
6-10	25	0,015
10-18	40	0,020
18-26	50	0,020
26-40	60	0,020

9.4. Балансировка патронов

Определение дисбаланса

Дисбаланс является смещением центра тяжести вращающейся массы от оси вращения. Вращающаяся масса включает в себя: машинный шпиндель, держатель инструмента, промежуточные компоненты (цанги), другие дополнительные элементы держателей инструмента (гайки) и инструмент. Причиной дисбаланса может быть геометрическая асимметрия, неправильные допуски, ошибки монтажа и т.д. Дисбаланс вызывает вибрацию установки, что, в свою очередь, сокращает срок службы инструмента, а также снижает качество обработки. Чтобы ограничить дисбаланс до допустимого уровня минимизируйте зазоры на шпинделе и установите подходящие инструменты и держатели инструмента. В особых случаях может потребоваться не только балансировка держателей инструмента, но и самого инструмента.

Балансировка

Балансировка снижает уровень дисбаланса благодаря перемещению центра вращающейся массы в направлении оси. Это достигается путем обеспечения правильной геометрии и добавления дополнительного веса (или удаления лишнего веса). Балансировка помогает лишь снизить уровень дисбаланса, но не избавиться от него полностью.

Классы точности баланса

С экономической точки зрения является невыгодным ужесточать требования к балансу вращательной массы. Для достижения компромисса между техническими и экономическими аспектами в стандарте ISO 1940 были введены классы точности баланса. Он определяет типы приложений для каждого класса:

- Класс G6,3 предназначен для деталей станков и для станков общего назначения
- Класс G2,5 предназначен для деталей высокоскоростных машин.

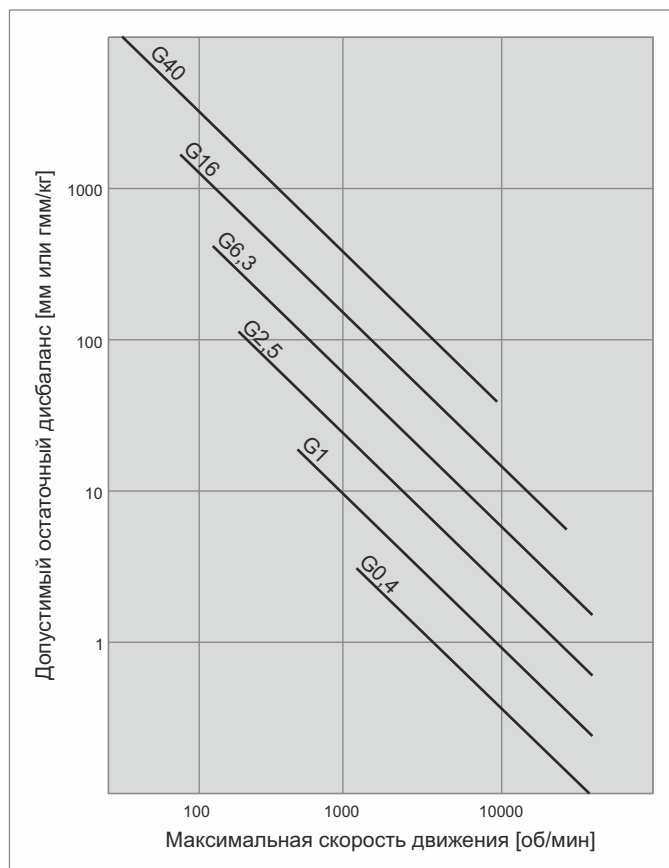

9.5. Хвостовики патронов

TR по DIN-6327

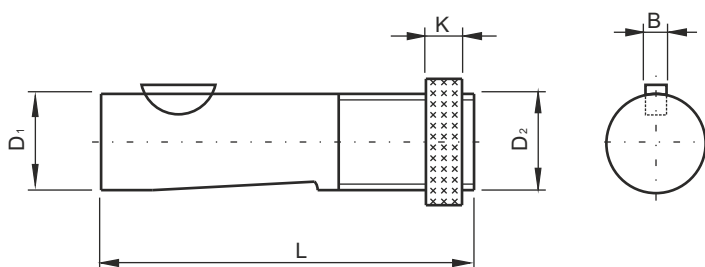

Хвостовик	D ₁	D ₂	L	B	K
TR20	20	TR20x1,5	88	5	12
TR28	28	TR28x2	95	6	12
TR36	36	TR36x2	118	8	14
TR48	48	TR48x2	144	10	18

Характеристики:

- Патроны из никель-хромомолибденовой стали, цементированные и закаленные до 58HRC.
- Прецизионный шлифованный хвостовик в допуске g5.

ISO по DIN-69871 A

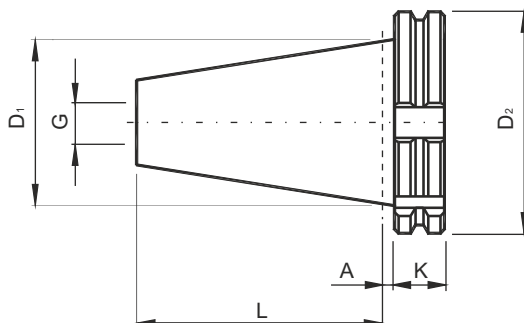

Конус	D ₁	D ₂	L	A	K	G
ISO30	31,75	50,00	47,80	3,2	15,9	M12
ISO40	44,45	63,55	68,40	3,2	15,9	M16
ISO50	69,85	97,50	101,75	3,2	15,9	M24

Версии:

- DIN-69871 A - хвостовик без внутреннего охлаждения
- DIN-69871 AD - с центральным отверстием
- DIN-69871 AD+B - с центральным отверстием и отверстиями на фланце

Характеристики:

- Патроны для станков с автоматической сменой инструмента
- Для крепления патрона в станке используются тяговые шпильки
- Патроны из никель-хромомолибденовой стали, цементированные и закаленные до 58HRC
- Точность конуса соответствует классу AT3
- Разъемы с максимальным уровнем биения 0,007мм
- Класс балансировки G6,3/8000rpm в стандартной версии

Конус Морзе по DIN-228

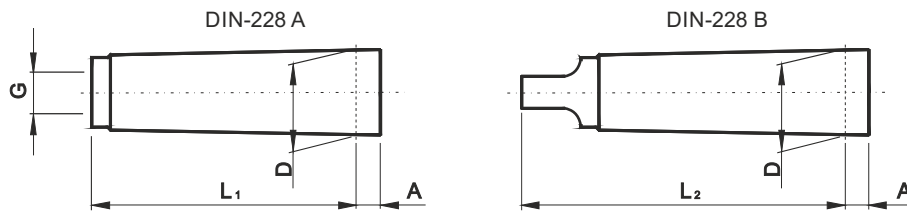

Конус	D	A	L ₁	L ₂	G
MK1	12,065	3,5	53,5	62,0	M6
MK2	17,780	5,0	64,0	75,0	M10
MK3	23,825	5,0	81,0	94,0	M12
MK4	31,267	6,5	102,5	117,5	M16
MK5	44,399	6,5	129,5	149,5	M20

Характеристики:

- Патроны из никель-хромомолибденовой стали, цементированные и закаленные до 58HRC.
- Класс точности соединительных поверхностей - АТ3.

по DIN-2080

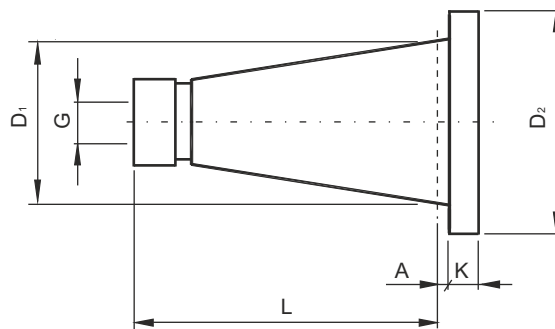

Конус	D ₁	D ₂	L	A	K	G
DIN30	31,75	50,0	68,4	1,6	8	M12
DIN40	44,45	63,0	93,4	1,6	10	M16
DIN50	69,85	97,5	126,8	3,2	12	M24

Характеристики:

- Патроны из никель-хромомолибденовой стали, цементированные и закаленные до 58HRC.
- Точность конуса соответствует классу АТ3
- Разъемы с максимальным уровнем биения 0,007мм

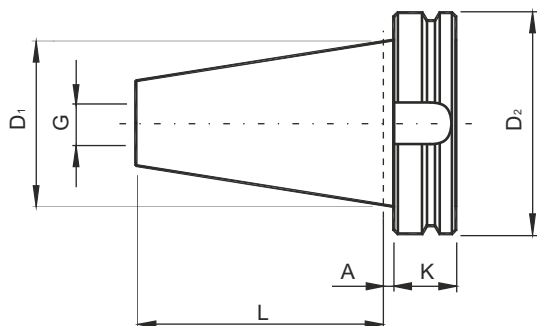
MAS BT по JIS B6339

Конус	D ₁	D ₂	L	A	K	G
BT30	31,75	46	48,4	2	22	M12
BT40	44,45	63	65,4	2	27	M16
BT50	69,85	100	101,8	3	38	M24

Варианты:

- хвостовик без внутреннего охлаждения
- с центральным отверстием
- с центральным отверстием и отверстиями на фланце

Характеристики:

- Патроны для станков с автоматической сменой инструмента
- Для крепления патрона в станке используются тяговые шпильки
- Патроны из никель-хромомолибденовой стали, цементированные и закаленные до 58HRC
- Точность конуса соответствует классу АТ3
- Разъемы с максимальным уровнем биения 0,007мм
- Максимальная скорость 10 000 об/мин в стандартной версии

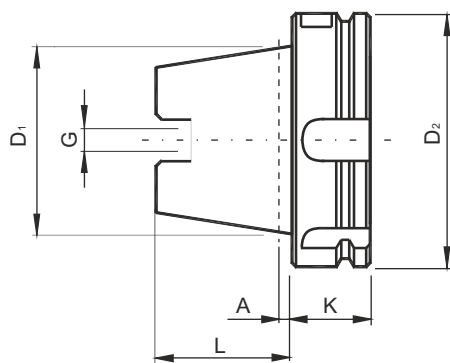
HSK по DIN-69893 A

Конус	D ₁	D ₂	L	A	K	G
HSK40	30	40	20	4,0	20	M12x1
HSK50	38	50	25	5,0	26	M16x1
HSK63	48	63	32	6,3	26	M18x1
HSK80	60	80	40	8,0	26	M20x1,5
HSK100	75	100	50	10,0	29	M24x1,5

Характеристики:

- Патроны для станков с автоматической сменой инструмента
- Патроны из никель-хромомолибденовой стали, цементированные и закаленные до 58HRC
- Точность конуса соответствует классу АТ3
- Разъемы с максимальным уровнем биения 0,007мм
- Класс балансировки G6,3/8000rpm в стандартной версии
- Конструкция хвостовика обеспечивает точность осевого позиционирования, высокую жесткость, высокую передачу крутящего момента на высоких скоростях

VDI по DIN-69880

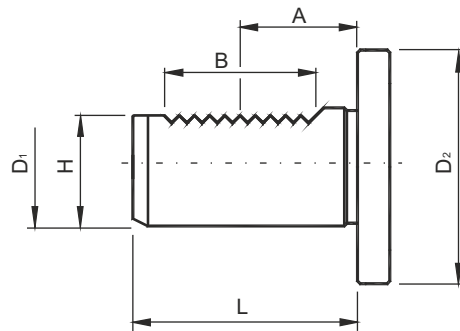

Хвостовик	D ₁	D ₂	H	L	A	B
VDI20	20	50	18	40	21,7	24
VDI25	25	58	23,5	48	21,7	24
VDI30	30	68	27	55	29,7	40
VDI40	40	83	36	63	29,7	40
VDI50	50	98	45	78	35,7	48

Характеристики:

- Патроны из никель-хромомолибденовой стали, цементированные и закаленные до 58HRC
- Цилиндрическая поверхность хвостовика шлифована с допуском h6

ЦИЛИНДРИЧЕСКИЙ по DIN-1835

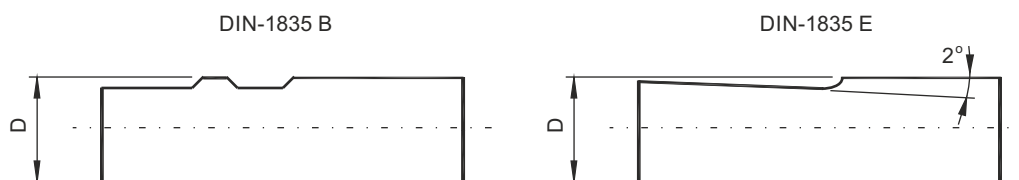

Weldon-хвостовик	D
W20	20
W25	25
W32	32
W40	40
W50	50

Варианты:

- DIN-1835 A - прямой цилиндрический хвостовик
- DIN-1835 B - WELDON: цилиндрический хвостовик с плоскостями, параллельными оси цилиндра
- DIN-1835 E - WHISTLE-NOTCH: цилиндрический хвостовик с лыской под углом 2 градуса

Характеристики:

- Патроны из никель-хромомолибденовой стали, цементированные и закаленные до 58HRC
- Цилиндрическая поверхность хвостовика шлифована с допуском h6

10. ИНФОРМАЦИОННЫЕ ТАБЛИЦЫ

10.1. Рекомендуемые диаметры отверстий для метчиков

Метрические Резьбы ISO

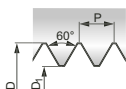
M Метрическая крупная резьба ISO DIN 13

MF Метрическая мелкая резьба ISO DIN 13

номинальный размер		D ₁ (6H)			номинальный размер		D ₁ (6H)			номинальный размер		D ₁ (6H)		
D мм	P мм	мин. мм	макс. мм		D мм	x P мм	мин. мм	макс. мм		D мм	x P мм	мин. мм	макс. мм	
M 1	0,25	0,729	0,785	0,75	M 2,5 x 0,35	2,121	2,221	2,15	M 35 x 1,5	33,376	33,676	33,5		
1,1	0,25	0,829	0,885	0,85	2,6 x 0,35	2,221	2,321	2,25	36 x 1,5	34,376	34,676	34,5		
1,2	0,25	0,929	0,985	0,95	3 x 0,35	2,621	2,721	2,65	36 x 2	33,835	34,210	34		
1,4	0,3	1,075	1,142	1,1	3,5 x 0,35	3,121	3,221	3,15	36 x 3	32,752	33,252	33		
1,6	0,35	1,221	1,321	1,25	4 x 0,35	3,621	3,721	3,65	38 x 1,5	36,376	36,676	36,5		
1,7	0,35	1,321	1,421	1,35	4 x 0,5	3,459	3,599	3,5	39 x 1,5	37,376	37,676	37,5		
1,8	0,35	1,421	1,521	1,45	5 x 0,5	4,459	4,599	4,5	39 x 2	36,835	37,210	37		
2	0,4	1,567	1,679	1,6	6 x 0,5	5,459	5,599	5,5	39 x 3	35,752	36,252	36		
2,2	0,45	1,713	1,838	1,75	6 x 0,75	5,188	5,378	5,2	40 x 1,5	38,376	38,676	38,5		
2,3	0,4	1,867	1,979	1,9	7 x 0,75	6,188	6,378	6,2	40 x 2	37,835	38,210	38		
2,5	0,45	2,013	2,138	2,05	8 x 0,75	7,188	7,378	7,2	42 x 1,5	40,376	40,676	40,5		
2,6	0,45	2,113	2,238	2,15	8 x 1	6,917	7,153	7	42 x 2	39,835	40,210	40		
3	0,5	2,459	2,599	2,5	9 x 0,75	8,188	8,378	8,2	42 x 3	38,752	39,252	39		
3,5	0,6	2,850	3,010	2,9	9 x 1	7,917	8,153	8	45 x 1,5	43,376	43,676	43,5		
4	0,7	3,242	3,422	3,3	10 x 0,75	9,188	9,378	9,2	45 x 2	42,835	43,210	43		
4,5	0,75	3,688	3,878	3,7	10 x 1	8,917	9,153	9	45 x 3	41,752	42,252	42		
5	0,8	4,134	4,334	4,2	10 x 1,25	8,647	8,912	8,8	48 x 1,5	46,376	46,676	46,5		
5,5	0,9	4,526	4,750	4,6	11 x 1	9,917	10,153	10	48 x 2	45,835	46,210	46		
6	1	4,917	5,153	5	12 x 1	10,917	11,153	11	48 x 3	44,752	45,252	45		
7	1	5,917	6,153	6	12 x 1,25	10,647	10,912	10,8	50 x 1,5	48,376	48,676	48,5		
8	1,25	6,647	6,912	6,8	12 x 1,5	10,376	10,676	10,5	50 x 2	47,835	48,210	48		
9	1,25	7,647	7,912	7,8	14 x 1	12,917	13,153	13	52 x 1,5	50,376	50,676	50,5		
10	1,5	8,376	8,676	8,5	14 x 1,25	12,647	12,912	12,8	52 x 2	49,835	50,210	50		
11	1,5	9,376	9,676	9,5	14 x 1,5	12,376	12,676	12,5	52 x 3	48,752	49,252	49		
12	1,75	10,106	10,441	10,2	15 x 1	13,917	14,153	14	56 x 3	52,752	53,252	53		
14	2	11,835	12,210	12	16 x 1	14,917	15,153	15	56 x 4	51,670	52,270	52		
16	2	13,835	14,210	14	16 x 1,5	14,376	14,676	14,5	60 x 4	55,670	56,270	56		
18	2,5	15,294	15,744	15,5	18 x 1	16,917	17,153	17	64 x 3	60,752	61,252	61		
20	2,5	17,294	17,744	17,5	18 x 1,5	16,376	16,676	16,5	64 x 4	59,670	60,270	60		
22	2,5	19,294	19,744	19,5	18 x 2	15,835	16,210	16	68 x 4	63,670	64,270	64		
24	3	20,752	21,252	21	20 x 1	18,917	19,153	19	70 x 3	66,752	67,252	67		
27	3	23,752	24,252	24	20 x 1,5	18,376	18,676	18,5	70 x 4	65,670	66,270	66		
30	3,5	26,211	26,771	26,5	20 x 2	17,835	18,210	18	72 x 3	68,752	69,252	69		
33	3,5	29,211	29,771	29,5	22 x 1	20,917	21,153	21	72 x 4	67,670	68,270	68		
36	4	31,670	32,270	32	22 x 1,5	20,376	20,676	20,5	72 x 6	65,505	66,305	66		
39	4	34,670	35,270	35	22 x 2	19,835	20,210	20	76 x 3	72,752	73,252	73		
42	4,5	37,129	37,799	37,5	24 x 1	22,917	23,153	23	76 x 4	71,670	72,270	72		
45	4,5	40,129	40,799	40,5	24 x 1,5	22,376	22,676	22,5	76 x 6	69,505	70,305	70		
48	5	42,587	43,297	43	24 x 2	21,835	22,210	22	80 x 4	75,670	76,270	76		
52	5	46,587	47,297	47	25 x 1,5	23,376	23,676	23,5	80 x 6	73,505	74,305	74		
56	5,5	50,046	50,796	50,5	26 x 1,5	24,376	24,676	24,5	85 x 3	81,752	82,252	82		
60	5,5	54,046	54,796	54,5	27 x 1,5	25,376	25,676	25,5	85 x 4	80,670	81,270	81		
64	6	57,505	58,305	58	27 x 2	24,835	25,210	25	90 x 3	86,752	87,252	87		
68	6	61,505	62,305	62	28 x 1,5	26,376	26,676	26,5	90 x 4	85,670	86,270	86		
					28 x 2	25,835	26,210	26	90 x 6	83,505	84,305	84		
					30 x 1,5	28,376	28,676	28,5	95 x 6	88,505	89,305	89		
					30 x 2	27,835	28,210	28	100 x 4	95,670	96,270	96		
					32 x 1,5	30,376	30,676	30,5	100 x 6	93,505	94,305	94		
					32 x 2	29,835	30,210	30	110 x 6	103,505	104,305	104		
					33 x 1,5	31,376	31,676	31,5	115 x 3	111,752	112,252	112		
					33 x 2	30,835	31,210	31	120 x 4	115,670	116,270	116		
					34 x 1,5	32,376	32,676	32,5	120 x 6	113,505	114,305	114		

10.1. Рекомендуемые диаметры резьбовых отверстий (продолжение)

Унифицированные Резьбы

UNC Унифицированная крупная резьба ANSI/ASME B1.1

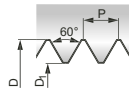

номинальный размер D - Gg/1" дюйм (нитек на дюйм)	D ₁ (2B)		 ММ
	мин. ММ	макс. ММ	
Nr. 1 - 64	1,425	1,582	1,55
Nr. 2 - 56	1,694	1,872	1,85
Nr. 3 - 48	1,941	2,146	2,1
Nr. 4 - 40	2,156	2,385	2,35
Nr. 5 - 40	2,487	2,697	2,65
Nr. 6 - 32	2,647	2,896	2,85
Nr. 8 - 32	3,307	3,528	3,5
Nr. 10 - 24	3,680	3,949	3,9
Nr. 12 - 24	4,341	4,590	4,5
1/4 - 20	4,976	5,268	5,1
5/16 - 18	6,411	6,734	6,6
3/8 - 16	7,805	8,164	8
7/16 - 14	9,149	9,550	9,4
1/2 - 13	10,584	11,016	10,8
9/16 - 12	11,996	12,456	12,2
5/8 - 11	13,376	13,868	13,5
3/4 - 10	16,299	16,833	16,5
7/8 - 9	19,169	19,748	19,5
1" - 8	21,963	22,598	22,25
1 1/8 - 7	24,648	25,349	25
1 1/4 - 7	27,823	28,524	28
1 3/8 - 6	30,343	31,120	30,75
1 1/2 - 6	33,518	34,295	34
1 3/4 - 5	38,951	39,814	39,5
2" - 4 1/2	44,689	45,598	45

UNF Унифицированная мелкая резьба ANSI/ASME B1.1

номинальный размер D - Gg/1" дюйм (нитек на дюйм)	D ₁ (2B)		 ММ
	мин. ММ	макс. ММ	
Nr. 2 - 64	1,755	1,913	1,85
Nr. 3 - 56	2,024	2,197	2,15
Nr. 4 - 48	2,271	2,459	2,4
Nr. 5 - 44	2,550	2,741	2,7
Nr. 6 - 40	2,817	3,012	2,95
Nr. 8 - 36	3,401	3,597	3,5
Nr. 10 - 32	3,967	4,168	4,1
Nr. 12 - 28	4,503	4,716	4,6
1/4 - 28	5,367	5,580	5,5
5/16 - 24	6,792	7,038	6,9
3/8 - 24	8,379	8,626	8,5
7/16 - 20	9,738	10,030	9,9
1/2 - 20	11,326	11,618	11,5
9/16 - 18	12,761	13,084	12,9
5/8 - 18	14,348	14,671	14,5
3/4 - 16	17,330	17,689	17,5
7/8 - 14	20,262	20,663	20,4
1" - 12	23,109	23,569	23,25
1 1/8 - 12	26,284	26,744	26,5
1 1/4 - 12	29,459	29,919	29,5
1 3/8 - 12	32,634	33,094	32,75
1 1/2 - 12	35,809	36,269	36

UN-8

номинальный размер D - Gg/1" дюйм (нитек на дюйм)	D ₁ (2B)		 ММ
	мин. ММ	макс. ММ	
1 1/8 - 8	25,138	25,773	25,4
1 1/4 - 8	28,313	28,948	28,6
1 1/2 - 8	34,663	35,298	35
1 3/4 - 8	41,013	41,648	41,3
2" - 8	47,363	47,998	47,7

UNEF

номинальный размер D - Gg/1" дюйм (нитек на дюйм)	D ₁ (2B)		 ММ
	мин. ММ	макс. ММ	
1/4 - 32	5,491	5,679	5,55
5/16 - 32	7,079	7,267	7,15
3/8 - 32	8,666	8,854	8,7
7/16 - 28	10,130	10,343	10,2
1/2 - 28	11,717	11,930	11,8
9/16 - 24	13,142	13,388	13,2
5/8 - 24	14,729	14,975	14,8
3/4 - 20	17,676	17,968	17,8
7/8 - 20	20,851	21,143	20,95
1" - 20	24,026	24,318	24,15

Цилиндрические трубные резьбы

G

трубная резьба Витворта DIN EN ISO 228

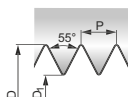

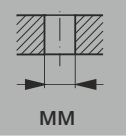
номинальный размер	D ₁		
	мин. мм	макс. мм	
D - P/1" (нитек на дюйм)	мин. мм	макс. мм	мм
G 1/16 - 28	6,561	6,843	6,8
1/8 - 28	8,566	8,848	8,8
1/4 - 19	11,445	11,890	11,8
3/8 - 19	14,950	15,395	15,25
1/2 - 14	18,631	19,172	19
5/8 - 14	20,587	21,128	21
3/4 - 14	24,117	24,658	24,5
7/8 - 14	27,877	28,418	28,25
1" - 11	30,291	30,931	30,75
1 1/8 - 11	34,939	35,579	35,5
1 1/4 - 11	38,952	39,592	39,5
1 3/8 - 11	41,365	42,005	41,75
1 1/2 - 11	44,845	45,485	45,25
1 5/8 - 11	49,030	49,670	49,5
1 3/4 - 11	50,788	51,428	51
2" - 11	56,656	57,296	57
2 1/4 - 11	62,752	63,392	63,3
2 1/2 - 11	72,226	72,866	72,8
2 3/4 - 11	78,576	79,216	79,1
3" - 11	84,926	85,566	85,5

NPSM

Американская Стандартная прямая трубная резьба ANSI/ASME B1.20.1 для механических соединений (ранее NPS)

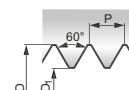

номинальный размер	D ₁		
	мин. мм	макс. мм	
D - P/1" (нитек на дюйм)	мин. мм	макс. мм	мм
1/8 - 27	9,093	9,246	9,1
1/4 - 18	11,887	12,217	12
3/8 - 18	15,316	15,545	15,5
1/2 - 14	18,974	19,279	19
3/4 - 14	24,333	24,638	24,5
1" - 11 1/2	30,505	30,759	30,5

Американская стандартная цилиндрическая трубная резьба ANSI B1.20.3 внутренняя цилиндрическая топливная резьба в сочетании с наружной конической трубной резьбой NPTF или PTF-SAE-SHORT; Проверка коническими калибрами

NPSF

номинальный размер	D ₁		
	мин. мм	макс. мм	
D - P/1" (нитек на дюйм)	мин. мм	макс. мм	мм
1/16 - 27	6,304	6,393	6,35
1/8 - 27	8,651	8,740	8,7
1/4 - 18	11,232	11,364	11,3
3/8 - 18	14,671	14,803	14,75
1/2 - 14	18,118	18,288	18,2
3/4 - 14	23,465	23,635	23,5
1" - 11 1/2	29,464	29,670	29,5

Rp(BSPF)

Цилиндрическая трубная резьба Витворта DIN EN 10226-1 и ISO 7-1 где герметичные соединения выполнены на резьбе

номинальный размер	D ₁		
	мин. мм	макс. мм	
D - P/1" (нитек на дюйм)	мин. мм	макс. мм	мм
Rp1/16 - 28	6,490	6,632	6,55
1/8 - 28	8,495	8,637	8,6
1/4 - 19	11,341	11,549	11,5
3/8 - 19	14,846	15,054	15
1/2 - 14	18,489	18,773	18,5
3/4 - 14	23,975	24,259	24
1" - 11	30,111	30,471	30,25



Конические трубные резьбы

Rc (BSPT)

Коническая трубная резьба Витворта DIN EN 10226-2 и ISO 7-1 где герметичные соединения выполнены на резьбе, конус 1:16

номинальный размер	D ₁	t ₁	t ₂
D - P/1" дюйм (нитек на дюйм)	мм	мм	мм
Rc1/16 - 28	6,15	11,1	9,5
1/8 - 28	8,15	11,1	9,5
1/4 - 19	10,85	16,3	14
3/8 - 19	14,3	16,7	14,4
1/2 - 14	17,8	22,3	19,1
3/4 - 14	23,2	23,6	20,4
1" - 11	29,2	28,3	24,3

номинальный размер	D ₂	D ₃ (JS11)	t ₁	t ₂
D - P/1" дюйм (нитек на дюйм)	мм	мм	мм	мм
Rc1/16 - 28	6,1	6,56	11,1	9,5
1/8 - 28	8,1	8,57	11,1	9,5
1/4 - 19	10,75	11,45	16,3	14
3/8 - 19	14,25	14,95	16,7	14,4
1/2 - 14	17,7	18,63	22,3	19,1
3/4 - 14	23,1	24,12	23,6	20,4
1" - 11	29,1	30,29	28,3	24,3

номинальный размер	D ₃ (JS11)	b	t min.	D ₁ min.
D - P/1" дюйм (нитек на дюйм)	мм	мм	мм	мм
Rc1/16 - 28	6,56	5,6	9,9	7,6 ^{+0,3}
1/8 - 28	8,57	5,6	9,9	9,6 ^{+0,3}
1/4 - 19	11,45	8,4	14,6	13 ^{+0,5}
3/8 - 19	14,95	8,8	15	16,5 ^{+0,5}
1/2 - 14	18,63	11,4	20	20,6 ^{+0,5}
3/4 - 14	24,12	12,7	21,3	26 ^{+0,5}
1" - 11	30,29	14,5	25,4	32,8 ^{+0,5}

NPT

Американская коническая трубная резьба ANSI/ASME B1.20.1 для резьб с сухим материалом, конус 1:16

номинальный размер	D ₁	t ₁	t ₂
D - P/1" дюйм (нитек на дюйм)	мм	мм	мм
1/16 - 27	6,15	11,8	9,7
1/8 - 27	8,5	11,9	9,75
1/4 - 18	11	17,4	14,25
3/8 - 18	14,4	17,7	14,55
1/2 - 14	17,8	23,1	19
3/4 - 14	23,15	23,6	19,5
1" - 11 1/2	29,05	28,4	23,4
1 1/4 - 11 1/2	37,8	28,9	23,9
1 1/2 - 11 1/2	43,85	28,9	23,9
2" - 11 1/2	55,85	29,3	24,35

номинальный размер	D ₂	D ₃ +0,05	t ₁	t ₂
D - P/1" дюйм (нитек на дюйм)	мм	мм	мм	мм
1/16 - 27	5,95	6,39	11,8	9,7
1/8 - 27	8,3	8,74	11,9	9,75
1/4 - 18	10,75	11,36	17,4	14,25
3/8 - 18	14,15	14,8	17,7	14,55
1/2 - 14	17,45	18,32	23,1	19
3/4 - 14	22,8	23,67	23,6	19,5
1" - 11 1/2	28,65	29,69	28,4	23,4
1 1/4 - 11 1/2	37,35	38,45	28,9	23,9
1 1/2 - 11 1/2	43,45	44,52	28,9	23,9
2" - 11 1/2	55,45	56,56	29,3	24,35

номинальный размер	D ₃ +0,05	b	t min.	D ₁ min.
D - P/1" дюйм (нитек на дюйм)	мм	мм	мм	мм
1/16 - 27	6,39	7	10	7,6
1/8 - 27	8,74	7	10	10
1/4 - 18	11,36	10,2	14,5	13,1
3/8 - 18	14,8	10,6	15	16,5
1/2 - 14	18,32	13,8	19	20,5
3/4 - 14	23,67	14,2	20	25,8
1" - 11 1/2	29,69	17	24	32,2
1 1/4 - 11 1/2	38,45	17,5	24,5	41
1 1/2 - 11 1/2	44,52	17,5	24,5	47,2
2" - 11 1/2	56,56	18	25	59,2

NPTF

Американская коническая трубная резьба ANSI B1.20.3 для резьб без сухого материала, конус 1:16

номинальный размер	D ₁	t ₁	t ₂
D - P/1" дюйм (нитек на дюйм)	мм	мм	мм
1/16 - 27	6,1	13	10,65
1/8 - 27	8,45	13	10,7
1/4 - 18	10,9	19,2	15,65
3/8 - 18	14,3	19,5	16
1/2 - 14	17,6	25,4	20,85
3/4 - 14	23	25,9	21,3
1" - 11 1/2	28,75	31,1	25,6
1 1/4 - 11 1/2	37,5	31,7	26,15
1 1/2 - 11 1/2	43,75	31,7	26,15
2" - 11 1/2	55,75	32,1	26,55

номинальный размер	D ₂	D ₃ +0,05	t ₁	t ₂
D - P/1" дюйм (нитек на дюйм)	мм	мм	мм	мм
1/16 - 27	5,95	6,41	13	10,65
1/8 - 27	8,3	8,76	13	10,7
1/4 - 18	10,75	11,4	19,2	15,65
3/8 - 18	14,15	14,84	19,5	16
1/2 - 14	17,45	18,33	25,4	20,85
3/4 - 14	22,8	23,68	25,9	21,3
1" - 11 1/2	28,65	29,72	31,1	25,6
1 1/4 - 11 1/2	37,35	38,48	31,7	26,15
1 1/2 - 11 1/2	43,45	44,55	31,7	26,15
2" - 11 1/2	55,45	56,59	32,1	26,55

номинальный размер	D ₃ +0,05	b	t min.	D ₁ min.
D - P/1" дюйм (нитек на дюйм)	мм	мм	мм	мм
1/16 - 27	6,41	8	11	7,4
1/8 - 27	8,76	8	11	9,8
1/4 - 18	11,4	11,6	15,5	12,9
3/8 - 18	14,84	12	16	16,3
1/2 - 14	18,33	15,6	20,5	20,3
3/4 - 14	23,68	16	21,5	25,6
1" - 11 1/2	29,72	19,2	26	32
1 1/4 - 11 1/2	38,48	19,7	26,5	40,8
1 1/2 - 11 1/2	44,55	19,7	26,5	47
2" - 11 1/2	56,59	20,2	27	59

Цилиндрическое сверление без использования расширителя

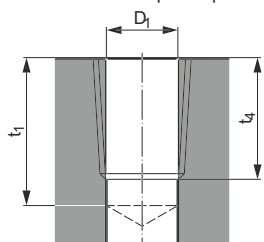

Цилиндрическое сверление и подготовка конического отверстия расширителем

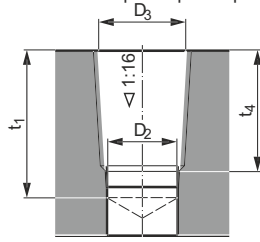

Рекомендуемая подготовка глухих отверстий (минимальная длина)

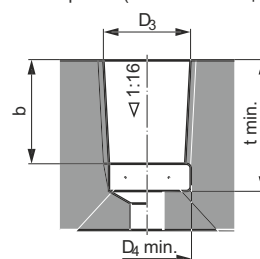

Трапецевидные и круглые резьбы

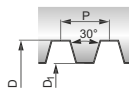
Tr Метрическая трапецевидная
крупная резьба ISO DIN 103

номинальный размер			D ₁ (7H)		 ММ
D ММ	x ММ	P ММ	мин. ММ	макс. ММ	
Tr 8	x	1,5	6,5	6,69	6,6
9	x	2	7	7,236	7,2
10	x	2	8	8,236	8,2
10	x	3	7	7,315	7,25
11	x	3	8	8,315	8,25
12	x	3	9	9,315	9,25
14	x	3	11	11,315	11,25
14	x	4	10	10,375	10,25
16	x	4	12	12,375	12,25
18	x	4	14	14,375	14,25
20	x	4	16	16,375	16,25
22	x	5	17	17,45	17,25
24	x	5	19	19,45	19,25
26	x	5	21	21,45	21,25
28	x	5	23	23,45	23,25
30	x	6	24	24,5	24,25
32	x	6	26	26,5	26,25
34	x	6	28	28,5	28,25
36	x	6	30	30,5	30,25
38	x	7	31	31,56	31,5
40	x	7	33	33,56	33,5
42	x	7	35	35,56	35,5
44	x	7	37	37,56	37,5
46	x	8	38	38,63	38,5
48	x	8	40	40,63	40,5
50	x	8	42	42,63	42,5
52	x	8	44	44,63	44,5

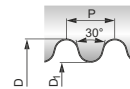
Rd Круглая резьба DIN 405

номинальный размер			D ₁ (7H)		 ММ
D дюйм	x P/1" (нитек на дюйм)		мин. ММ	макс. ММ	
Rd 8	x	10	5,714	6,164	6
9	x	10	6,714	7,164	7
10	x	10	7,714	8,164	8
11	x	10	8,714	9,164	9
12	x	10	9,714	10,164	10
14	x	8	11,142	11,672	11,5
16	x	8	13,142	13,672	13,5
18	x	8	15,142	15,672	15,5
20	x	8	17,142	17,672	17,5
22	x	8	19,142	19,672	19,5
24	x	8	21,142	21,672	21,5
26	x	8	23,142	23,672	23,5
28	x	8	25,142	25,672	25,5
30	x	8	27,142	27,672	27,5

BSF

номинальный размер		D ₁		 ММ
D дюйм	- P/1" (нитек на дюйм)	мин. ММ	макс. ММ	
BSF 3/16	- 32	3,747	4,006	4
1/4	- 26	5,100	5,398	5,3
5/16	- 22	6,459	6,817	6,8
3/8	- 20	7,899	8,331	8,3
7/16	- 18	9,304	9,764	9,7
1/2	- 16	10,668	11,163	11,1
5/8	- 14	13,553	14,094	14
3/4	- 12	16,337	16,939	16,75
7/8	- 11	19,268	19,909	19,75
1"	- 10	22,149	22,835	22,75

BSW

номинальный размер		D ₁		 ММ
D дюйм	- P/1" (нитек на дюйм)	мин. ММ	макс. ММ	
BSW 1/16	- 60	1,045	1,230	1,15
3/32	- 48	1,704	1,912	1,85
1/8	- 40	2,362	2,591	2,55
5/32	- 32	2,952	3,214	3,2
3/16	- 24	3,406	3,744	3,7
7/32	- 24	4,201	4,539	4,5
1/4	- 20	4,724	5,156	5,1
5/16	- 18	6,129	6,589	6,5
3/8	- 16	7,493	7,988	7,9
7/16	- 14	8,791	9,332	9,25
1/2	- 12	9,987	10,589	10,5
9/16	- 12	11,575	12,177	12
5/8	- 11	12,918	13,559	13,5
3/4	- 10	15,799	16,485	16,4
7/8	- 9	18,613	19,355	19,25
1"	- 8	21,336	22,149	22
1 1/8	- 7	23,927	24,831	24,75
1 1/4	- 7	27,102	28,006	27,75
1 3/8	- 6	29,504	30,528	30,5
1 1/2	- 6	32,680	33,703	33,5
1 5/8	- 5	34,769	35,963	35,5
1 3/4	- 5	37,943	39,136	39
1 7/8	- 4 1/2	40,396	41,702	41,5
2"	- 4 1/2	43,571	44,877	44,5

Резьбы для Аэрокосмической промышленности

MJ Резьба MJ DIN ISO 5855

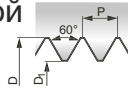

номинальный размер	D ₁		
	D мм	P мм	
MJ 3 x 0,5	2,513	2,653	2,6
4 x 0,7	3,318	3,498	3,4
5 x 0,8	4,221	4,421	4,3
6 x 1	5,026	5,216	5,1
8 x 1	7,026	7,216	7,1
8 x 1,25	6,782	6,994	6,9
10 x 1,25	8,782	8,994	8,9
10 x 1,5	8,539	8,775	8,6

UNJF Унифицированная мелкая резьба ASME B1.15

номинальный размер	D ₁		
	D - P/1" дюйм (нитек на дюйм)	мин. мм	
Nr. 4 - 48	2,329	2,466	2,4
Nr. 6 - 40	2,888	3,053	3
Nr. 8 - 36	3,480	3,663	3,55
Nr. 10 - 32	4,054	4,255	4,15
1/4 - 28	5,466	5,662	5,55
5/16 - 24	6,906	7,109	7
3/8 - 24	8,494	8,679	8,6

UNJC Унифицированная крупная резьба ASME B1.15

номинальный размер	D ₁		
	D - P/1" дюйм (нитек на дюйм)	мин. мм	
Nr. 4 - 40	2,228	2,393	2,3
Nr. 6 - 32	2,733	2,939	2,85
Nr. 8 - 32	3,393	3,599	3,5
Nr. 10 - 24	3,795	4,064	3,9
1/4 - 20	5,113	5,387	5,25
5/16 - 18	6,563	6,833	6,7
3/8 - 16	7,978	8,255	8,1

Резьбы для стальных труб

Pg Резьба для стальных труб DIN 40430

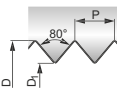

номинальный размер	D ₁			
	D мм	P/1" (нитек на дюйм)		мин. мм
Pg 7	20	11,28	11,43	11,35
9	18	13,86	14,01	13,95
11	18	17,26	17,41	17,35
13,5	18	19,06	19,21	19,15
16	18	21,16	21,31	21,25
21	16	26,78	27,03	26,95
29	16	35,48	35,73	35,6
36	16	45,48	45,73	45,6
42	16	52,48	52,73	52,6
48	16	57,78	58,03	57,9

Винтовые спиральные резьбы для резьбовых вставок

EG M (STI)

Резьба крупная метрическая ISO DIN 8140-2

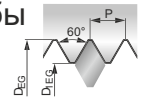

номинальный размер	D _{EG}		D _{1EG}		
	D мм	P мм	мин. мм	макс. мм	
EG M2,5	0,45	3,084	2,597	2,697	2,65
3	0,5	3,650	3,108	3,220	3,15
4	0,7	4,910	4,152	4,292	4,2
5	0,8	6,040	5,174	5,334	5,25
6	1	7,300	6,217	6,407	6,3
8	1,25	9,624	8,271	8,483	8,4
10	1,5	11,948	10,324	10,560	10,5
12	1,75	14,274	12,379	12,644	12,5
14	2	16,598	14,433	14,733	14,5
16	2	18,598	16,433	16,733	16,5
18	2,5	21,248	18,541	18,896	18,75
20	2,5	23,248	20,541	20,896	20,75

EG UNC (STI) Унифицированная крупная резьба ASME B18.29.1

номинальный размер	D _{EG}		D _{1EG}		
	D - P/1" мм (нитек на дюйм)	мин. мм	мин. мм	макс. мм	
EGNr. 4 - 40	3,671	2,982	3,178	3,1	
Nr. 6 - 32	4,536	3,678	3,879	3,8	
Nr. 8 - 32	5,197	4,338	4,523	4,4	
Nr. 10 - 24	6,200	5,054	5,283	5,2	
1/4 - 20	8,002	6,628	6,872	6,7	
5/16 - 18	9,771	8,244	8,490	8,4	
3/8 - 16	11,587	9,867	10,126	10	
7/16 - 14	13,469	11,506	11,783	11,6	
1/2 - 13	15,237	13,121	13,393	13,3	
9/16 - 12	17,039	14,747	15,031	14,9	
5/8 - 11	18,875	16,376	16,673	16,5	
3/4 - 10	22,349	19,598	19,908	19,75	

EG UNF (STI) Унифицированная мелкая резьба ASME B18.29.1

номинальный размер	D _{EG}		D _{1EG}		
	D мм	P/1" (нитек на дюйм)	мин. мм	макс. мм	
EGNr. 4 - 48	3,533	2,959	3,119	3	
Nr. 6 - 40	4,330	3,642	3,815	3,7	
Nr. 8 - 36	5,083	4,318	4,496	4,4	
Nr. 10 - 32	5,858	4,999	5,184	5,1	
1/4 - 28	7,528	6,545	6,720	6,6	
5/16 - 24	9,312	8,166	8,351	8,25	
3/8 - 24	10,899	9,753	9,931	9,8	
7/16 - 20	12,763	11,389	11,587	11,5	
1/2 - 20	14,352	12,978	13,176	13,1	
9/16 - 18	16,121	14,594	14,800	14,7	
5/8 - 18	17,709	16,182	16,388	16,25	
3/4 - 16	21,112	19,392	19,608	19,5	

10.2. ПРОФИЛЬ КОНИЧЕСКОЙ ВНЕШНЕЙ РЕЗЬБЫ NPT

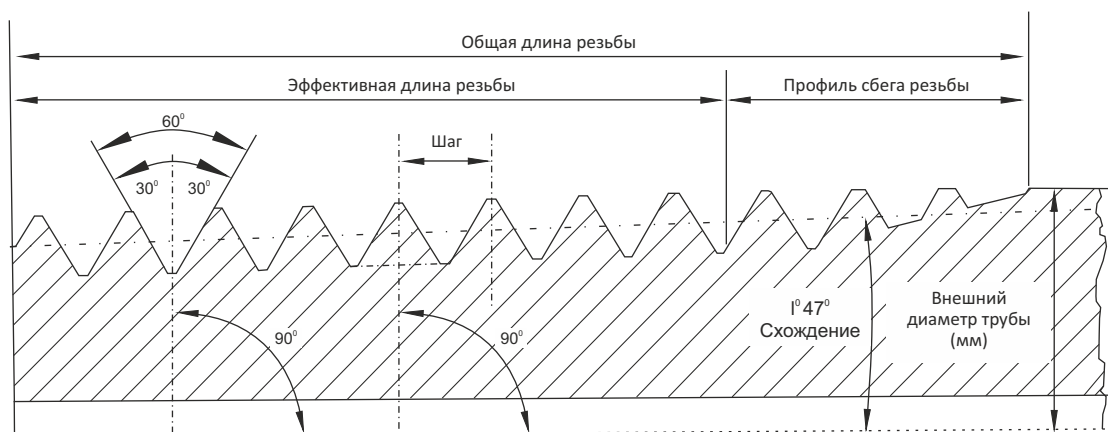

Диаметр резьбы (дюйм)	Шаг резьбы (нитек на дюйм)	Внешний диаметр трубы (мм)	Общая длина резьбы (мм)
1/16	27	7,950	9,896
1/8	27	10,287	9,967
1/4	18	13,716	15,103
3/8	18	17,145	15,255
1/2	14	21,336	19,850
3/4	14	26,670	20,155
1	11.1/2	33,401	25,006
1.1/4	11.1/2	42,164	25,616
1.1/2	11.1/2	48,260	26,040
2	11.1/2	60,325	26,878
2.1/2	8	73,025	39,908
3	8	88,900	41,496
3.1/2	8	101,600	42,766
4	8	114,300	44,036

10.3. Рекомендуемые диаметры отверстий для метчиков-раскатников

M

номинальный размер		
D мм	P мм	
M 1	0,25	0,9
1,1	0,25	1
1,2	0,25	1,1
1,4	0,3	1,28
1,6	0,35	1,47
1,7	0,35	1,57
1,8	0,35	1,67
2	0,4	1,85
2,2	0,45	2,03
2,3	0,4	2,15
2,5	0,45	2,33
2,6	0,45	2,43
3	0,5	2,8
3,5	0,6	3,25
4	0,7	3,7
4,5	0,75	4,2
5	0,8	4,65
5,5	0,9	5,1
6	1	5,6
7	1	6,6
8	1,25	7,45
9	1,25	8,45
10	1,5	9,35
12	1,75	11,25
14	2	13,1
16	2	15,1
18	2,5	16,85
20	2,5	18,85
22	2,5	20,85
24	3	22,65
27	3	25,65
30	3,5	28,4
33	3,5	31,4
36	4	34,15
39	4	37,15
42	4,5	39,9
45	4,5	42,9
48	5	45,65

MF

номинальный размер		
D мм	P мм	
M 2,5 x 0,35		2,37
2,6 x 0,35		2,47
3 x 0,35		2,88
3,5 x 0,35		3,38
4 x 0,5		3,8
5 x 0,5		4,8
6 x 0,5		5,8
6 x 0,75		5,7
7 x 0,75		6,7
8 x 0,75		7,7
8 x 1		7,6
9 x 0,75		8,7
9 x 1		8,6
10 x 0,75		9,7
10 x 1		9,6
10 x 1,25		9,45
11 x 1		10,6
12 x 1		11,6
12 x 1,25		11,45
12 x 1,5		11,35
14 x 1		13,6
14 x 1,25		13,45
14 x 1,5		13,35
15 x 1		14,6
15 x 1,5		14,35
16 x 1		15,6
16 x 1,5		15,35
18 x 1		17,6
18 x 1,5		17,35
18 x 2		17,1
20 x 1		19,6
20 x 1,5		19,35
20 x 2		19,1
24 x 2		23,1
30 x 2		29,1
36 x 3		34,65
42 x 4		40,15
48 x 3		46,65

UNC

номинальный размер		
D дюйм	P/1" (нитек на дюйм)	
Nr. 4 - 40		2,55
Nr. 5 - 40		2,9
Nr. 6 - 32		3,15
Nr. 8 - 32		3,8
Nr. 10 - 24		4,35
Nr. 12 - 24		5
1/4 - 20		5,75
3/8 - 16		8,8
7/16 - 14		10,25
1/2 - 13		11,8
9/16 - 12		13,3
5/8 - 11		14,8
3/4 - 10		17,85
7/8 - 9		20,9
1" - 8		23,9

UNF

номинальный размер		
D дюйм	P/1" (нитек на дюйм)	
Nr. 2 - 64		2,02
Nr. 3 - 56		2,32
Nr. 4 - 48		2,62
Nr. 5 - 44		2,92
Nr. 6 - 40		3,22
Nr. 8 - 36		3,85
Nr. 10 - 32		4,45
Nr. 12 - 28		5,1
1/4 - 28		5,95
5/16 - 24		7,45
3/8 - 24		9,05
7/16 - 20		10,55
1/2 - 20		12,15
9/16 - 18		13,65
5/8 - 18		15,25
3/4 - 16		18,35
7/8 - 14		21,4
1" - 12		24,45

G

номинальный размер		
D дюйм	P/1" (нитек на дюйм)	
G 1/16 - 28		7,25
1/8 - 28		9,25
1/4 - 19		12,55
3/8 - 19		16,05
1/2 - 14		20,1
5/8 - 14		22,05
3/4 - 14		25,6
7/8 - 14		29,35
1" - 11		32,15

10.4. Формулы для вычисления технологических параметров сверления и нарезания резьбы

Соотношение линейной скорости, скорости вращения и диаметра инструмента

Скорость резания V_c [м/мин]

$$v_c = \frac{d_1 \times \pi \times n}{1000}$$

Скорость вращения шпинделя [об/мин]

$$n = \frac{1000 \times v_c}{d_1 \times \pi}$$

Скорость подчи V_f [мм/мин]

- при нарезании резьбы

$$v_f = p \times n$$

- при сверлении

$$v_f = f_o \times n$$

$$f_o = \frac{v_f}{n}$$

Крутящий момент при нарезании резьбы M_d [Nm]

$$M_d = \frac{p^2 \times d_1 \times k_c}{8000}$$

Крутящий момент при сверлении M_c [Nm]

$$M_c = \frac{F_c \times z \times d_1}{4000}$$

Усилие резания на один зуб F_c [Н]

$$F_c = \frac{d_1 \times f_o \times k_c}{2}$$

Мощность P [кВт]

$$P = \frac{M_{c,d} \times 2 \times \pi \times n}{60000}$$

Обозначения:

d_1 - номинальный диаметр инструмента [мм]

v_c - скорость резания [м/мин]

n - скорость вращения шпинделя [об/мин]

p - шаг резьбы [мм]

P - мощность [кВт]

v_f - скорость подачи [м/мин]

f_o - подача на оборот [об/мин]

k_c - удельное сопротивление материала заготовки [МПа]

M_d - крутящий момент при нарезании резьбы [Нм]

z - режущие кромки

10.5. Рекомендуемый диаметр резьбовых шпилек

M	
РЕЗЬБА	ø d
M 1	0,96
M 1,1	1,05
M 1,2	1,15
M 1,4	1,35
M 1,6	1,55
M 1,8	1,75
M 2	1,95
M 2,2	2,15
M 2,5	2,42
M 3	2,92
M 3,5	3,41
M 4	3,90
M 4,5	4,40
M 5	4,90
M 6	5,88
M 7	6,88
M 8	7,86
M 9	8,86
M 10	9,85
M 11	10,85
M 12	11,83
M 14	13,82
M 16	15,82
M 18	17,79
M 20	19,79
M 22	21,79
M 24	23,76
M 27	26,76
M 30	29,73
M 33	32,73
M 36	35,70
M 39	38,70
M 42	41,68
M 45	44,68
M 48	47,66
M 52	51,66
M 56	55,65
M 60	59,65
M 64	63,62
M 68	67,62

MF	
РЕЗЬБА	ø d
M3,5x0,5	3,43
M4x0,5	3,92
M4,5x0,5	4,43
M5x0,5	4,92
M5x0,75	4,91
M5,5x0,5	5,43
M5,5x0,75	5,42
M6x0,5	5,92
M6x0,75	5,90
M7x0,75	6,90
M8x0,5	7,92
M8x0,75	7,90
M8x1	7,88
M9x0,75	8,90
M9x1	8,88
M10x0,75	9,90
M10x1	9,88
M10x1,25	9,86
M11x0,75	10,91
M11x1	10,88
M12x1	11,88
M12x1,25	11,86
M12x1,5	11,85
M14x1	13,88
M14x1,5	13,85

MF cd.	
РЕЗЬБА	ø d
M15x1	14,88
M15x1,5	14,85
M16x1	15,88
M16x1,5	15,85
M17x1	16,88
M17x1,5	16,85
M18x1	17,88
M18 x1,5	17,85
M18x2	17,82
M20x1	19,88
M20x1,5	19,85
M20x2	19,82
M22x1	21,88
M22x1,5	21,85
M22x2	21,82
M24x1	23,88
M24x1,5	23,85
M24x2	23,82
M25x1	24,88
M25x1,5	24,85
M25x2	24,82
M26x1,5	25,85
M27x1	26,88
M27x1,5	26,85
M27x2	26,82
M28x1	27,88
M28x1,5	27,85
M28x2	27,82
M30x1	29,88
M30x1,5	29,85
M30x2	29,82
M30x3	29,76
M32x1,5	31,85
M32x2	31,82
M33x1,5	32,85
M33x2	32,82
M33x3	32,76
M35x1,5	34,85
M36x1,5	35,85
M36x2	35,82
M36x3	35,76
M38x1,5	37,85
M39x1,5	38,85
M39x2	38,82
M39x3	38,76
M40x1,5	39,85
M40x2	39,82
M40x3	39,76
M42x1,5	41,85
M42x2	41,82
M42x3	41,76
M45x1,5	44,85
M45x2	44,82
M45x3	44,76
M48x1,5	47,85
M48x2	47,82
M48x3	47,76
M48x4	47,73
M50x1,5	49,85
M50x2	49,82
M50x3	49,76
M52x1,5	51,85
M52x2	51,82
M52x3	51,76
M52x4	51,73
M55x1,5	54,85
M55x2	54,82
M55x3	54,76
M55x4	54,73
M56x1,5	55,85
M56x2	55,82
M56x3	55,76
M56x4	55,73

G	
РЕЗЬБА	ø d
G - 1/8"	9,62
G - 1/4"	13,03
G - 3/8"	16,54
G - 1/2"	20,81
G - 5/8"	22,77
G - 3/4"	26,30
G - 7/8"	30,06
G - 1"	33,07
G - 1.1/8"	37,72
G - 1.1/4"	41,73
G - 1.3/8"	44,14
G - 1.1/2"	47,62
G - 1.3/4"	53,57
G - 2"	59,43
G - 2.1/4"	65,49

BSW	
РЕЗЬБА	ø d
1/8 - 40	3,09
3/16 - 24	4,66
1/4 - 20	6,24
5/16 - 18	7,82
3/8 - 16	9,40
7/16 - 14	10,98
1/2 - 12	12,56
9/16 - 12	14,14
5/8 - 11	15,72
3/4 - 10	18,89
7/8 - 9	22,10
1 - 8	25,27

NPT	
РЕЗЬБА	ø d
1/8"	9,99
1/4"	13,26
3/8"	16,67
1/2"	20,71
3/4"	26,03
1"	32,59

UNC	
РЕЗЬБА	ø d
No 5 - 40	3,09
No 6 - 32	3,41
No 8 - 32	4,07
No 10 - 24	4,71
No 12 - 24	5,37
1/4 - 20	6,22
5/16 - 18	7,80
3/8 - 16	9,37
7/16 - 14	10,95
1/2 - 13	12,52
9/16 - 12	14,10
5/8 - 11	15,68
3/4 - 10	18,84
7/8 - 9	22,00
1 - 8	25,16
1.1/8 - 7	28,31
1.1/4 - 7	31,49
1.3/8 - 6	34,63
1.1/2 - 6	37,80
1.3/4 - 5	44,12
2 - 4.1/2	50,45

UNF	
РЕЗЬБА	ø d
No 5 - 44	3,10
No 6 - 40	3,42
No 8 - 36	4,08
No 10 - 32	4,73
No 12 - 28	5,38
1/4 - 28	6,24
5/16 - 24	7,82
3/8 - 24	9,41
7/16 - 20	10,98
1/2 - 20	12,56
9/16 - 18	14,14
5/8 - 18	15,73
3/4 - 16	18,89
7/8 - 14	22,05
1 - 12	25,21
1.1/8 - 12	28,38
1.1/4 - 12	31,55
1.3/8 - 12	34,73
1.1/2 - 12	37,90

R	
РЕЗЬБА	ø d
R - 1/8"	9,48
R - 1/4"	12,78
R - 3/8"	16,26
R - 1/2"	20,44
R - 3/4"	25,85
R - 1"	32,60

BSF	
РЕЗЬБА	ø d
3/16 - 32	4,76
1/4 - 26	6,25
5/16 - 22	7,83
3/8 - 20	9,41
7/16 - 18	10,99
1/2 - 16	12,57
9/16 - 16	14,16
5/8 - 14	15,73
3/4 - 12	18,89
7/8 - 11	22,11
1 - 10	25,28

Pg	
РЕЗЬБА	ø d
Pg 7	12,40
Pg 9	15,10
Pg 11	18,50
Pg 13,5	20,30
Pg 16	22,40
Pg 21	28,15
Pg 29	36,85
Pg 36	46,85
Pg 42	53,85
Pg 48	59,15

10.6. Соотношение линейной скорости (V), скорости вращения (n) и диаметра инструмента (d)

d ₁ [мм]	V = p × d × n / 1000 [м/мин]														
	2	3	4	5	6	8	10	12	15	18	20	25	30	35	40
3	212	318	424	531	637	849	1061	1273	1592	1910	2122	2653	3183	3714	4244
3,5	182	273	364	455	546	728	909	1091	1364	1637	1819	2274	2728	3183	3638
4	159	239	318	398	477	637	796	955	1194	1432	1592	1989	2387	2785	3183
4,5	141	212	283	354	424	566	707	849	1061	1273	1415	1768	2122	2476	2829
5	127	191	255	318	382	509	637	764	955	1146	1273	1592	1910	2228	2546
6	106	159	212	265	318	424	531	637	796	955	1061	1326	1592	1857	2122
7	91	136	182	227	273	364	455	546	682	819	909	1137	1364	1592	1819
8	80	119	159	199	239	318	398	477	597	716	796	995	1194	1393	1592
9	71	106	141	177	212	283	354	424	531	673	707	884	1061	1238	1415
10	64	95	127	159	191	255	318	382	477	573	637	796	955	1114	1273
11	58	87	116	145	174	231	289	347	434	521	579	723	868	1013	1157
12	53	80	106	133	159	212	265	318	398	477	531	663	796	928	1061
14	45	68	91	114	136	182	227	273	341	409	455	568	682	796	909
16	40	60	80	99	119	159	199	239	298	358	398	497	597	696	796
18	35	53	71	88	106	141	177	212	265	318	354	442	531	619	707
20	32	48	64	80	95	127	159	191	239	286	318	398	477	557	637
22	29	43	58	72	87	116	145	174	217	260	289	362	434	506	579
24	27	40	53	66	80	106	133	159	199	239	265	332	398	464	531
27	24	35	47	59	71	94	118	141	177	212	236	295	354	413	472
30	21	32	42	53	64	85	106	127	159	191	212	265	318	371	424
33	19	29	39	48	58	77	96	116	145	174	193	241	289	338	386
36	18	27	35	44	53	71	88	106	133	159	177	221	265	309	354
39	16	24	33	41	49	65	82	98	122	147	163	204	245	286	326
42	15	23	30	38	45	61	76	91	114	136	152	189	227	265	303
45	14	21	28	35	42	57	71	85	106	127	141	177	212	248	283
48	13	20	27	33	40	53	66	80	99	119	133	166	199	232	265
52	12	18	24	31	37	49	61	73	92	110	122	153	184	214	245

10.7. Сравнение шкал твердости Rm, HRC, HB, HV10

Rm [МПа]	HRC	HB	HV 10	Rm [МПа]	HRC	HB	HV 10	Rm [МПа]	HRC	HB	HV 10
240		71	75	690		204	215	1360	43	402	423
255		76	80	705		209	220	1400	44	413	434
270		81	85	720		214	225	1440	45	424	446
285		86	90	740		219	230	1480	46	435	458
305		90	95	755		223	235	1530	47	449	473
320		95	100	770		228	240	1570	48	460	484
335		100	105	785		233	245	1620	49	472	497
350		105	110	800	22	238	250	1680	50	488	514
370		109	115	820	23	242	255	1730	51	501	527
385		114	120	835	24	247	260	1890	52	517	544
400		119	125	860	25	255	268	1845	53	532	560
415		124	130	870	26	258	272	1910	54	549	578
430		128	135	900	27	266	280	1980	55	567	596
450		133	140	920	28	273	287	2050	56	584	615
465		138	145	940	29	278	293	2140	57	607	639
480		143	150	970	30	287	302		58	622	655
495		147	155	995	31	295	310		59		675
510		152	160	1020	32	301	317		60		698
530		157	165	1050	33	311	327		61		720
545		162	170	1080	34	319	336		62		745
560		166	175	1110	35	328	345		63		773
575		171	180	1140	36	337	355		64		800
595		176	185	1170	37	346	364		65		829
610		181	190	1200	38	354	373		66		864
625		185	195	1230	39	363	382		67		900
640		190	200	1260	40	372	392		68		940
660		195	205	1300	41	383	403				
675		199	210	1330	42	393	413				

10.8. Предельные значения среднего диаметра - внутренняя резьба

Резьба метрическая ISO

номинальный размер		6H		6G	
M	MF	мин.	макс.	мин.	макс.
M 2		1,740	1,830	1,759	1,849
M 2,2		1,908	2,003	1,928	2,023
M 2,5		2,208	2,303	2,228	2,323
M 3		2,675	2,775	2,695	2,795
M 3,5		3,110	3,222	3,131	3,243
M 4		3,545	3,663	3,567	3,685
	M 4x0,5	3,675	3,775	3,695	3,795
M 4,5		4,013	4,131	4,035	4,153
M 5		4,480	4,605	4,504	4,629
	M 5x0,5	4,675	4,775	4,695	4,795
M 6		5,350	5,500	5,376	5,526
	M 6x0,75	5,513	5,645	5,535	5,667
M 7		6,350	6,500	6,376	6,526
M 8		7,188	7,348	7,216	7,376
	M 8x0,75	7,513	7,645	7,535	7,667
	M 8x1	7,350	7,500	7,376	7,526
M 9		8,188	8,348	8,216	8,376
M 10		9,026	9,206	9,058	9,238
	M 10x0,75	9,513	9,645	9,535	9,667
	M 10x1	9,350	9,500	9,376	9,526
	M 10x1,25	9,188	9,348	9,216	9,376
M 12		10,863	11,063	10,897	11,097
	M 12x1	11,350	11,510	11,376	11,536
	M 12x1,25	11,188	11,368	11,216	11,396
	M 12x1,5	11,026	11,216	11,058	11,248
M 14		12,701	12,913	12,739	12,951
	M 14x1,5	13,026	13,216	13,058	13,248
M 16		14,701	14,913	14,739	14,951
	M 16x1,5	15,026	15,216	15,058	15,248
M 18		16,376	16,600	16,418	16,642
	M 18x1,5	17,026	17,216	17,058	17,248
M 20		18,376	18,600	18,418	18,642
	M 20x1,5	19,026	19,216	19,058	19,248
	M 20x2	18,701	18,913	18,739	18,951
M 22		20,376	20,600	20,418	20,642
	M 22x1,5	21,026	21,216	21,058	21,248
M 24		22,051	22,316	22,099	22,364
	M 24x1,5	23,026	23,226	23,058	23,258
	M 24x2	22,701	22,925	22,739	22,963
	M 26x1,5	25,026	25,226	25,058	25,258
M 27		25,051	25,316	25,099	25,364
	M 27x1,5	26,026	26,226	26,058	26,258
	M 27x2	25,701	25,925	25,739	25,963
	M 28x1,5	27,026	27,226	27,058	27,258
M 30		27,727	28,007	27,780	28,060
	M 30x1,5	29,026	29,226	29,058	29,258
	M 30x2	28,701	28,925	28,739	28,963
	M 32x1,5	31,026	31,226	31,058	31,258
	M 32x2	30,701	30,925	30,739	30,963
M 33		30,727	31,007	30,780	31,060
	M 33x1,5	32,026	32,226	32,058	32,258
	M 33x2	31,701	31,925	31,739	31,963
M 36		33,402	33,702	33,462	33,762
	M 36x1,5	35,026	35,226	35,058	35,258
	M 36x2	34,701	34,925	34,739	34,963
	M 36x3	34,051	34,316	34,099	34,364
M 39		36,402	36,702	36,462	36,762
	M 39x1,5	38,026	38,226	38,058	38,258
	M 39x2	37,701	37,925	37,739	37,963
	M 39x3	37,051	37,316	37,099	37,364
	M 40x1,5	39,026	39,226	39,058	39,258
M 42		39,077	39,392	39,140	39,455
	M 42x1,5	41,026	41,226	41,058	41,258
	M 42x2	40,701	40,925	40,739	40,963
	M 42x3	40,051	40,316	40,099	40,364
M 45		42,077	42,392	42,140	42,455
	M 45x1,5	44,026	44,226	44,058	44,258
	M 45x2	43,701	43,925	43,739	43,963
	M 45x3	43,051	43,316	43,099	43,364
M 48		44,752	45,087	44,823	45,158
	M 48x1,5	47,026	47,238	47,058	47,270
	M 48x2	46,701	46,937	46,739	46,975
	M 48x3	46,051	46,331	46,099	46,379
M 52		48,752	49,087	48,823	49,158
	M 52x2	50,701	50,937	50,739	50,975
	M 52x3	50,051	50,331	50,099	50,379

Американская унифицированная резьба UNC и UNF

Номинальный размер		2B / 3B	2B	3B
UNC	UNF	мин.	макс.	макс.
No 5 - 40		2,764	2,847	2,827
	No 5 - 44	2,799	2,880	2,860
No 6 - 32		2,990	3,084	3,058
	No 6 - 40	3,094	3,180	3,157
No 8 - 32		3,650	3,746	3,721
	No 8 - 36	3,708	3,800	3,777
No 10 - 24		4,138	4,247	4,219
	No 10 - 32	4,310	4,409	4,384
No 12 - 24		4,798	4,910	4,882
	No 12 - 28	4,897	5,004	4,976
1/4 - 20		5,524	5,648	5,616
	1/4 - 28	5,761	5,870	5,842
5/16 - 18		7,021	7,155	7,120
	5/16 - 24	7,249	7,371	7,341
3/8 - 16		8,494	8,639	8,603
	3/8 - 24	8,837	8,961	8,931
7/16 - 14		9,934	10,089	10,051
	7/16 - 20	10,287	10,424	10,391
1/2 - 13		11,430	11,595	11,552
	1/2 - 20	11,874	12,017	11,981
9/16 - 12		12,913	13,086	13,043
	9/16 - 18	13,371	13,520	13,482
5/8 - 11		14,376	14,559	14,514
	5/8 - 18	14,958	15,110	15,072
3/4 - 10		17,399	17,595	17,544
	3/4 - 16	18,019	18,184	18,143
7/8 - 9		20,391	20,599	20,546
	7/8 - 14	21,026	21,224	21,181
1 - 8		23,338	23,561	23,505
	1 - 12	24,026	24,224	24,171
1.1/8 - 7		26,218	26,457	26,398
	1.1/8 - 12	27,201	27,424	27,351
1.1/4 - 7		29,393	29,637	29,576
	1.1/4 - 12	30,376	30,619	30,528
1.3/8 - 6		32,174	32,438	32,372
	1.3/8 - 12	33,551	33,799	33,706
1.1/2 - 6		35,349	35,616	35,550
	1.1/2 - 12	36,726	36,937	36,886
1.3/4 - 5		41,151	41,445	41,372
2 - 4.1/2		47,135	47,450	47,371

Трубная резьба Витворта G

Номинальный размер	мин.	макс.
G-1/16"	7,142	7,249
G-1/8"	9,147	9,254
G-1/4"	12,301	12,426
G-3/8"	15,806	15,931
G-1/2"	19,793	19,935
G-5/8"	21,749	21,891
G-3/4"	25,279	25,421
G-7/8"	29,039	29,181
G-1"	31,770	31,950
G-1.1/8"	36,418	36,598
G-1.1/4"	40,431	40,611
G-1.3/8"	42,844	43,024
G-1.1/2"	46,324	46,504
G-1.3/4"	52,267	52,447
G-2"	58,135	58,315

БЛАНК ВЫБОРА ИНСТРУМЕНТА



заполняется представителем FANAR

Дата: Представитель: Запрос №

Дата:

МЕТЧИК

РАСКАТНИК

ДАННЫЕ КЛИЕНТА

Название и адрес фирмы:

Контактное лицо: тел.

1. Вид резьбы

1.1. Размер:

1.2. Допуск:

1.3. Характер резьбового отверстия:

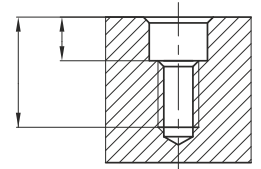
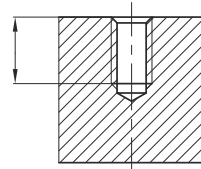
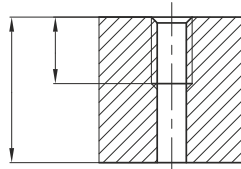
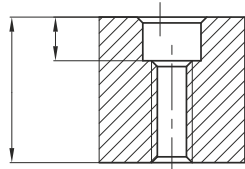
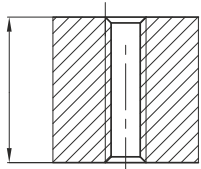

2. Станок и резьбонарезное оборудование

2.1. Тип станка:

2.2. Метод нарезания резьбы: горизонтальный вертикальный 2.3. Принудительная подача: да нет

2.4. Тип держателя / ручки:

Осевая компенсация: да нет

Радиальная компенсация: да нет

Фрикционный патрон: да нет

2.5. Скорость резания:м/мин,об/мин

2.6. Смазка: ручная автоматическая Смазочный материал:

3. Рабочий материал

3.1. Тип элемента:

3.2. Материал (символ):

3.3. Твердость:HV Прочность на растяжение Rm.....Н/мм²

3.4. Тип резьбового отверстия: Сверлением Литое Развертыванием Другое:

4. Инструмент

4.1. Инструмент, используемый в настоящее время (тип):

4.2. Изнашиваемость:

4.3. Ожидаемые размеры инструмента:

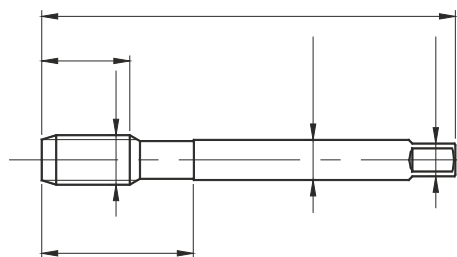

5. Примечания

БЛАНК ВЫБОРА ИНСТРУМЕНТА



заполняется представителем FANAR

Дата: Представитель: Запрос №

Дата:

ПЛАШКИ

ДАННЫЕ КЛИЕНТА

Название и адрес фирмы:

Контактное лицо: тел.

1. Вид резьбы

1.1. Размер: 1.2. Допуск:

1.3. Характер резьбовой шпильки:

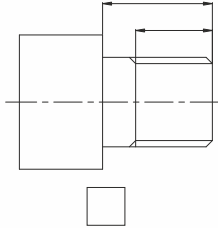

2. Станок и резьбонарезное оборудование

2.1. Тип станка:

2.2. Метод нарезания резьбы: горизонтальный вертикальный 2.3. Принудительная подача: да нет

2.4. Тип держателя / ручки:

Осевая компенсация: да нет

Радиальная компенсация: да нет

Фрикционный патрон: да нет

2.5. Скорость резания:м/мин,об/мин

2.6. Смазка: ручная автоматическая Смазочный материал:

3. Рабочий материал

3.1. Тип элемента:

3.2. Материал (символ):

3.3. Твердость:HV Прочность на растяжение Rm.....Н/мм²

3.4. Тип резьбовой шпильки: Точением Литое Другое:

4. Инструмент

4.1. Инструмент, используемый в настоящее время (тип):

4.2. Изнашиваемость:

4.3. Ожидаемые размеры инструмента:

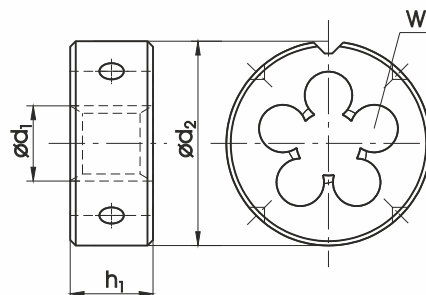

5. Примечания

БЛАНК ВЫБОРА ИНСТРУМЕНТА



заполняется представителем FANAR

Дата: Представитель: Запрос №

Дата:

Специальные сверла

ДАННЫЕ КЛИЕНТА

Название и адрес фирмы:

Контактное лицо: тел.

1. Эскиз обрабатываемой детали:

1.1. Название детали: 1.2. Материал заготовки:

1.3. Твердость:

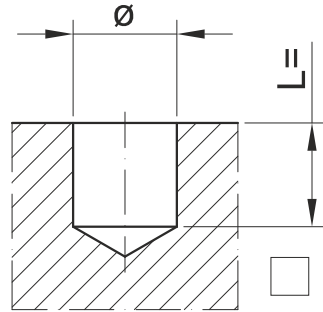

2. Инструмент:

2.1. Номер чертежа, который дополнительно прикладывается к запросу:

2.2. Предлагаемый материал:

2.3. Предлагаемый материал PVD:

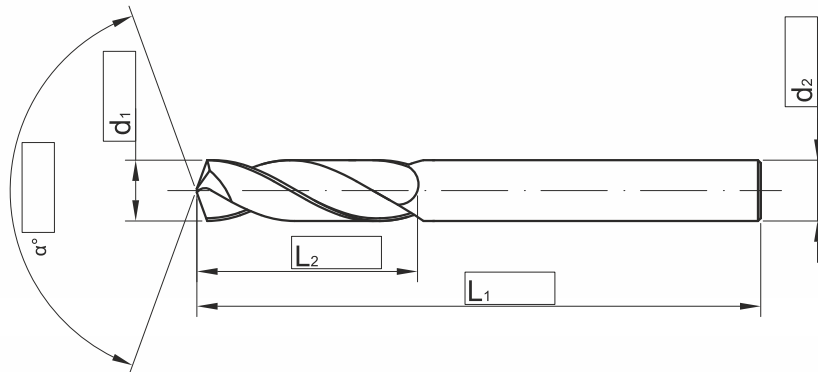

3. Выполнение:

3.1. Направление канавок: Правое Левое Прямые Угол наклона:

3.2. Направление вращения: Правое Левое

3.3. Охлаждение: Внешнее Внутреннее Без охлаждения

3.4. Хвостовик: DIN-6535-NA DIN-6535-NB DIN-65350NE

4. Станок:

4.1. Тип станка:

4.2. Тип шпинделя:

4.3. Мощность [кВт]:

4.4. Максимальная скорость вращения [об/мин]:

5. Примечания

БЛАНК ВЫБОРА ИНСТРУМЕНТА



заполняется представителем FANAR

Дата: Представитель: Запрос №

Дата: **Специальные одноступенчатые сверла**

ДАННЫЕ КЛИЕНТА

Название и адрес фирмы:

Контактное лицо: тел.

1. Эскиз обрабатываемой детали:

1.1. Название детали: 1.2. Материал заготовки:

1.3. Твердость:

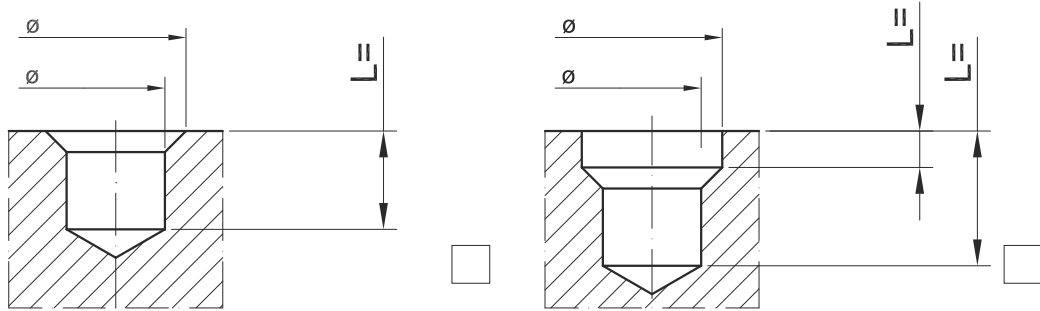

2. Инструмент:

2.1. Номер чертежа, который дополнительно прикладывается к запросу:

2.2. Предлагаемый материал:

2.3. Предлагаемый материал PVD:

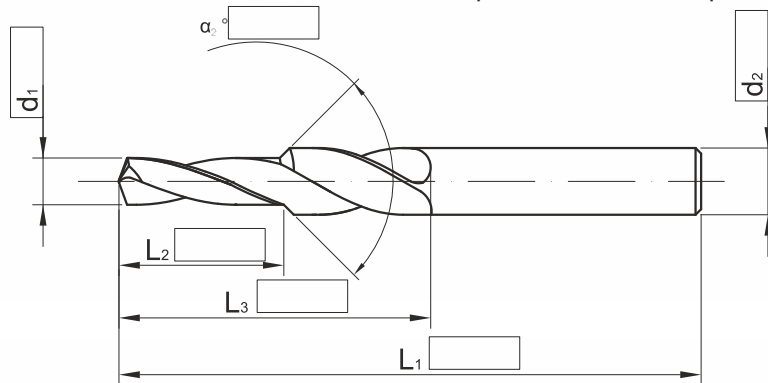

3. Выполнение:

3.1. Направление канавок: Правое Левое Прямые Угол наклона:

3.2. Направление вращения: Правое Левое

3.3. Охлаждение: Внешнее Внутреннее Без охлаждения

3.4. Хвостовик: DIN-6535-NA DIN-6535-NB DIN-65350NE

4. Станок:

4.1. Тип станка:

4.2. Тип шпинделя:

4.3. Мощность [кВт]:

4.4. Максимальная скорость вращения [об/мин]:

5. Примечания

БЛАНК ВЫБОРА ИНСТРУМЕНТА



заполняется представителем FANAR

Дата: Представитель: Запрос №

Дата: **Специальные двухступенчатые сверла**

ДАННЫЕ КЛИЕНТА

Название и адрес фирмы:

Контактное лицо: тел.

1. Эскиз обрабатываемой детали:

1.1. Название детали: 1.2. Материал заготовки:

1.3. Твердость:

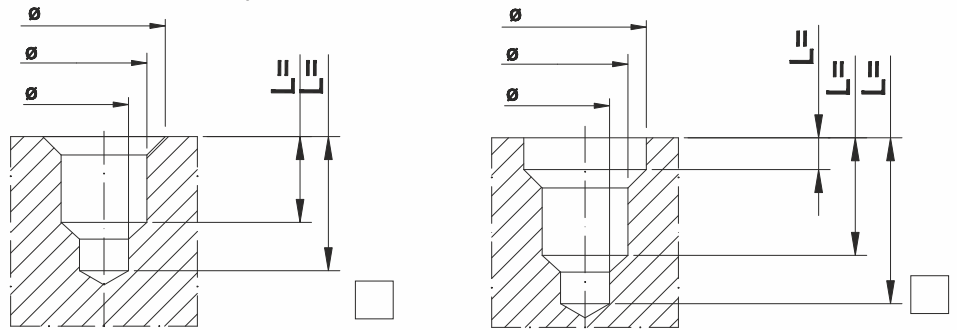

2. Инструмент:

2.1. Номер чертежа, который дополнительно прикладывается к запросу:

2.2. Предлагаемый материал:

2.3. Предлагаемый материал PVD:

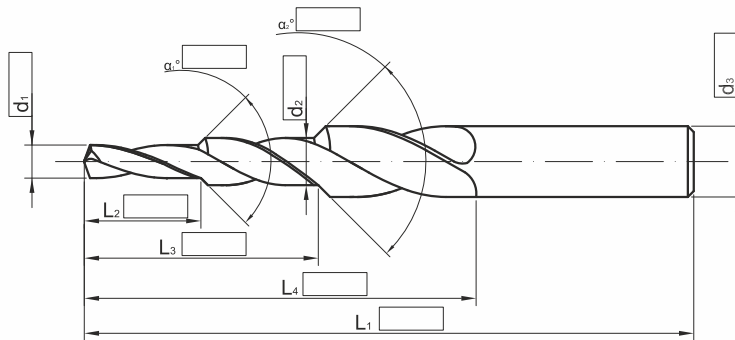

3. Выполнение:

3.1. Направление канавок: Правое Левое Прямые Угол наклона:

3.2. Направление вращения: Правое Левое

3.3. Охлаждение: Внешнее Внутреннее Без охлаждения

3.4. Хвостовик: DIN-6535-NA DIN-6535-NB DIN-65350NE

4. Станок:

4.1. Тип станка:

4.2. Тип шпинделя:

4.3. Мощность [кВт]:

4.4. Максимальная скорость вращения [об/мин]:

5. Примечания

БЛАНК ВЫБОРА ИНСТРУМЕНТА



заполняется представителем FANAR

Дата: Представитель: Запрос №

Дата:

Специальные сверла

ДАННЫЕ КЛИЕНТА

Название и адрес фирмы:

Контактное лицо: тел.

1. Эскиз обрабатываемой детали:

1.1. Название детали: 1.2. Материал заготовки:

1.3. Твердость:

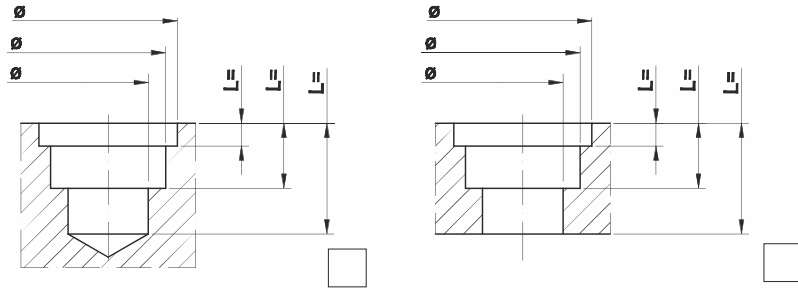

2. Инструмент:

2.1. Номер чертежа, который дополнительно прилагается к запросу:

2.2. Предлагаемый материал:

2.3. Предлагаемый материал PVD:

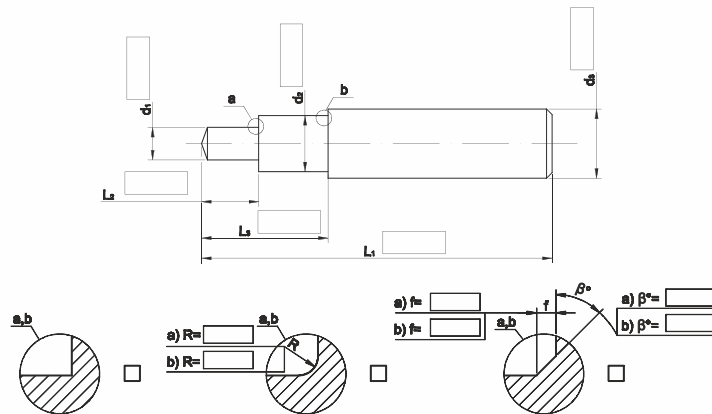

3. Выполнение:

3.1. Направление канавок: Правое Левое Прямые Угол наклона:

3.2. Направление вращения: Правое Левое

3.3. Охлаждение: Внешнее Внутреннее Без охлаждения

3.4. Хвостовик: DIN-6535-НА DIN-6535-НВ DIN-65350HE

4. Станок:

4.1. Тип станка:

4.2. Тип шпинделя:

4.3. Мощность [кВт]:

4.4. Максимальная скорость вращения [об/мин]:

5. Примечания

R-RF60/48	FZA	190	R-OGK-MK3/FZ31-A	OGK	183	R-U20/D3	R	195	V0-103000-6525	214	ИНДЕКС	W	страница
R-FZ13	FZ	189	R-OGK-MK4/FZ48	OGK	183	R-U20/D3,5	R	195	V0-200000-0050	214	W1-011021		151
R-FZ19	FZ	189	R-OGK-MK4/FZ48-A	OGK	183	R-U20/D4	R	195	V0-200000-0063	214	W1-641010-0420	WST	148
R-FZ31	FZ	189	R-OGK-MK5/FZ60	OGK	183	R-U20/D4,5	R	195	V0-200000-0071	214	W1-641020-0630	WST	148
R-FZ48	FZ	189	R-OGK-MK5/FZ60-A	OGK	183	R-U20/D5	R	195	V0-200000-0080	214	W1-641030-0638	WST	148
R-FZ60	FZ	189	R-OGK-TR20/FZ19	OGK	183	R-U20/D5,5	R	195	V0-200000-0090	214	W1-642030-0636	WST	148
R-FZA19/JT2		219	R-OGK-TR28/FZ31	OGK	183	R-U20/D6	R	195	V0-200000-0100	214	W1-642040-0637	WST	148
R-FZA19/JT6		219	R-OGK-TR36/FZ19	OGK	183	R-U20/D6,5	R	195	V0-211130-0206	215	W1-645030-0636	WST	148
R-FZA31/JT6		219	R-OGK-TR36/FZ19	OGK	183	R-U20/D7	R	195	V0-211130-0206	216	W1-645040-0637	WST	148
R-FZS13	FZS	188	R-OGK-TR36/FZ31	OGK	183	R-U20/D7,5	R	195	V0-211130-0206	217	W1-648010-0420	WST	148
R-FZS19	FZS	188	R-OGK-TR36/FZ48	OGK	183	R-U20/D8	R	195	V0-211130-0306	215	W1-648020-0630	WST	148
R-FZS31	FZS	188	R-OGK-TR36/FZ60	OGK	183	R-U20/D8,5	R	195	V0-211130-0306	216	W1-648030-0638	WST	148
R-FZS48	FZS	188	R-OGK-TR48/FZ48	OGK	183	R-U20/D9	R	195	V0-211130-0306	217	W2-001012		149
R-FZS60	FZS	188	R-OGK-TR48/FZ60	OGK	183	R-U20/D9,5	R	195	V0-211130-0406	215	W2-003012		149
R-MS-1-D12	MS	178	R-OGK-VD120/FZ19	OGK	185	R-U25/D10	R	195	V0-211130-0406	216	W2-003013		149
R-MS-2-W25	MS	178	R-OGK-VD120/FZ31	OGK	185	R-U25/D10,5	R	195	V0-211130-0406	217	W2-101811	WK	145
R-MS-3-HSK100A	MS	178	R-OGK-VD125/FZ19	OGK	185	R-U25/D11	R	195	V0-211130-0607	215	W2-101811	WK	146
R-MS-3-HSK100A-MQLMS	MS	179	R-OGK-VD125/FZ31	OGK	185	R-U25/D11,5	R	195	V0-211130-0607	216	W2-101811	WK	147
R-MS-3-HSK63A	MS	178	R-OGK-VD130/FZ19	OGK	185	R-U25/D12	R	195	V0-211130-0607	215	W2-103811	WK	145
R-MS-3-HSK63A-MQL MS	MS	179	R-OGK-VD130/FZ31	OGK	185	R-U25/D12,5	R	195	V0-211130-0707	215	W2-103811	WK	146
R-MS-3-HSK80A	MS	178	R-OGK-VD140/FZ19	OGK	185	R-U25/D13	R	195	V0-211130-0707	216	W2-103811	WK	147
R-MS-3-HSK80A-MQL MS	MS	179	R-OGK-VD140/FZ31	OGK	185	R-U25/D13,5	R	195	V0-211130-0808	215	W9-001014		149
R-MS-3-W25	MS	178	R-OGK-VD150/FZ48	OGK	185	R-U25/D14	R	195	V0-211130-0808	216	W9-054011		152
R-MS-4-HSK100A	MS	178	R-OGK-VD150/FZ48	OGK	185	R-U25/D15	R	195	V0-211130-0808	217	W9-054012		152
R-MS-4-HSK100A-MQLMS	MS	179	R-OGK-V20/FZ19	OGK	186	R-U25/D15,5	R	195	V0-211130-0909	215	W9-604013	WK	129
R-MS-4-HSK63A	MS	178	R-OGK-V20/FZ31	OGK	186	R-U25/D16	R	195	V0-211130-0909	216	W9-604013	WK	130
R-MS-4-HSK63A-MQL MS	MS	179	R-OGK-V25/FZ19	OGK	186	R-U25/D16	R	195	V0-211130-0909	216	W9-604013	WK	131
R-MS-4-HSK80A	MS	178	R-OGK-W25/FZ31	OGK	186	R-U25/D3	R	195	V0-211130-0909	217	W9-604013	WK	132
R-MS-4-HSK80A-MQL MS	MS	179	R-OGK-W32/FZ19	OGK	186	R-U25/D3,5	R	195	V0-211130-1010	215	W9-604013	WK	133
R-MS-4-W25	MS	178	R-OGK-W32/FZ31	OGK	186	R-U25/D4	R	195	V0-211130-1010	216	W9-604013	WK	134
R-MS-5-HSK100A	MS	178	R-OGK-W32/FZ48	OGK	186	R-U25/D4,5	R	195	V0-211130-1010	217	W9-604033	WK	129
R-MS-5-HSK63A	MS	178	R-OGK-W40/FZ19	OGK	186	R-U25/D5	R	195	V0-211130-1111	215	W9-604033	WK	130
R-MS-5-HSK80A	MS	178	R-OGK-W40/FZ31	OGK	186	R-U25/D5,5	R	195	V0-211130-1111	216	W9-604033	WK	131
R-MS-5-W25	MS	178	R-OGK-W40/FZ48	OGK	186	R-U25/D6	R	195	V0-211130-1111	217	W9-604033	WK	132
R-MS-6-W40	MS	178	R-OGN-JT6/RF15-Z	OGN	187	R-U25/D6,5	R	195	V0-211130-1212	215	W9-604033	WK	133
R-NT11-SE	R	195	R-OGN-JT6/RF23-Z	OGN	187	R-U25/D7	R	195	V0-211130-1212	216	W9-604033	WK	134
R-NT16-SE	R	195	R-OGN-M20/RF32-Z	OGN	187	R-U25/D7,5	R	195	V0-211200-1414	215	W9-604M33	WK	129
R-NT20-SE	R	195	R-OGSS-BT40/A20	OGSS	180	R-U25/D8	R	195	V0-211200-1414	216	W9-604M33	WK	131
R-NT25-S	R	195	R-OGSS-BT40/A32	OGSS	180	R-U25/D8,5	R	195	V0-211200-1616	215	W9-604M33	WK	132
R-NT40-S	R	195	R-OGSS-BT50/A20	OGSS	180	R-U25/D9	R	195	V0-211200-1616	216	W9-604M33	WK	133
R-NT50-S	R	195	R-OGSS-BT50/A32	OGSS	180	R-U25/D9,5	R	195	V0-211200-1616	217	W9-604M33	WK	134
R-NTU16-SE	R	195	R-OGSS-BT50/A50	OGSS	180	ИНДЕКС	S	страница	V0-211200-1818	215	W9-611733	WK	142
R-NTU20-SE	R	195	R-OGSS-C40/A20	OGSS	182	S3-100111	A	161	V0-211200-1818	216	W9-611733	WK	143
R-NTU25-S	R	195	R-OGSS-C40/A32	OGSS	182	S3-100112	A	161	V0-211200-1818	217	W9-611733	WK	144
R-NTU40-S	R	195	R-OGSS-C50/A20	OGSS	182	S3-100161	A	162	V0-211200-2020	215	W9-61B733	WK	142
R-NTU50-S	R	195	R-OGSS-C50/A32	OGSS	182	S3-100162	A	162	V0-211200-2020	216	W9-61B733	WK	143
R-OGK-BT30/FZ19	OGK	184	R-OGSS-C63/A20	OGSS	182	S3-301161	M	163	V0-211200-2020	217	W9-624063	WK	135
R-OGK-BT30/FZ31	OGK	184	R-OGSS-C63/A32	OGSS	182	S3-301161	MF	164	V0-211230-0206	215	W9-624063	WK	136
R-OGK-BT40/FZ19	OGK	184	R-OGSS-C63/A50	OGSS	182	S3-302100	BSW	171	V0-211230-0206	216	W9-624063	WK	137
R-OGK-BT40/FZ31	OGK	184	R-OGSS-C80/A20	OGSS	182	S3-302161	M	163	V0-211230-0306	215	W9-704010	WT	139
R-OGK-BT40/FZ48	OGK	184	R-OGSS-C80/A32	OGSS	182	S3-302161	MF	164	V0-211230-0306	216	W9-704010	WT	140
R-OGK-BT40/FZ60	OGK	184	R-OGSS-C80/A50	OGSS	182	S3-302162	M	163	V0-211230-0306	217	W9-714010	WT	141
R-OGK-BT50/FZ19	OGK	184	R-OGSS-HSK100/A20	OGSS	181	S3-302162	MF	164	V0-211230-0406	215	W9-801014	WK	138
R-OGK-BT50/FZ31	OGK	184	R-OGSS-HSK100/A32	OGSS	181	S3-302162	MF	165	V0-211230-0406	216	W9-900002	WDG	150
R-OGK-BT50/FZ48	OGK	184	R-OGSS-HSK100/A50	OGSS	181	S3-302171	TR	173	V0-211230-0406	217	W9-900002-0000	WDG	208
R-OGK-BT50/FZ60	OGK	184	R-OGSS-HSK40/A20	OGSS	181	S3-302180	G	168	V0-211230-0607	215	ИНДЕКС	Y	страница
R-OGK-C40/FZ19	OGK	186	R-OGSS-HSK40/A32	OGSS	181	S3-302186	UNC	166	V0-211230-0607	216	Y3-412100	PG	170
R-OGK-C40/FZ31	OGK	186	R-OGSS-HSK50/A20	OGSS	181	S3-302186	UNC	167	V0-211230-0607	217	Y3-412100	BSW	171
R-OGK-C50/FZ19	OGK	186	R-OGSS-HSK50/A32	OGSS	181	S3-302187	UNC	166	V0-211230-0707	215	Y3-412162	M	163
R-OGK-C50/FZ31	OGK	186	R-OGSS-HSK63/A20	OGSS	181	S3-302187	UNC	166	V0-211230-0707	216	Y3-412162	MF	164
R-OGK-C63/FZ19	OGK	186	R-OGSS-ISO40/A20	OGSS	180	S3-302187	UNC	167	V0-211230-0707	217	Y3-412162	MF	165
R-OGK-C63/FZ31	OGK	186	R-OGSS-ISO40/A32	OGSS	180	S3-322100	NPT	172	V0-211230-0808	215	Y3-412174	TR	173
R-OGK-C63/FZ48	OGK	186	R-OGSS-ISO50/A20	OGSS	180	S3-332102	RC/RP	169	V0-211230-0808	216	Y3-412180	G	168
R-OGK-C80/FZ19	OGK	186	R-OGSS-ISO50/A32	OGSS	180	S3-332105	RC/RP	169	V0-211230-0909	215	Y3-412182	UNC	166
R-OGK-C80/FZ31	OGK	186	R-OGSS-ISO50/A50	OGSS	180	S3-832100	PG	170	V0-211230-0909	216	Y3-422100	BSW	171
R-OGK-DIN30/FZ19	OGK	183	R-OGSS-VD130/A20	OGSS	181	T0-100110-0250		213	V0-211230-1010	215	Y3-422162	M	163
R-OGK-DIN30/FZ31	OGK	183	R-OGSS-VD140/A32	OGSS	181	T0-100110-0500		213	V0-211230-1010	216	Y3-422162	MF	164
R-OGK-DIN40/FZ19	OGK	183	R-OGSS-VD140/A32	OGSS	181	T0-100110-5000		213	V0-211230-1010	217	Y3-422162	MF	165
R-OGK-DIN40/FZ31	OGK	183	R-OGSS-W25/A20	OGSS	182	T0-100310-0250		213	V0-211230-1112	215	Y3-422180	TR	173
R-OGK-DIN40/FZ48	OGK	183	R-OGSS-W25/A32	OGSS	182	T0-100310-0500		213	V0-211230-1112	216	Y3-422182	G	168
R-OGK-DIN50/FZ19	OGK	183	R-OGSS-W40/A50	OGSS	182	T0-100410-1000		213	V0-211230-1212	215	Y3-422182	UNC	166
R-OGK-DIN50/FZ31	OGK	183	R-OTR-BT40/D25	MS	179	T1-030010		157	V0-211230-1212	216	Y3-432100	NPT	172
R-OGK-DIN50/FZ48	OGK	183	R-OTR-BT50/D25	MS	179	T1-040010		153	V0-211230-1414	215	Y3-432103	RC/RP	169
R-OGK-DIN50/FZ60	OGK	183	R-OTR-CAT40/D25	MS	179	T1-040210		154	V0-211230-1616	215	Y3-432104	RC/RP	169
R-OGK-HSK100/FZ19	OGK	185	R-OTR-CAT50/D25	MS	179	T1-040310		154	V0-211230-1616	216	Y3-450100	PG	170
R-OGK-HSK100/FZ31	OGK	185	R-OTR-CAT50/D25	MS	179	T1-043010		153	V0-211330-1616	217	ИНДЕКС	Z	страница
R-OGK-HSK50/FZ19	OGK	185	R-OTR-ISO40/D25	MS	179	T1-044010		156	V0-211330-1818	215	Z1-007020-0310		206
R-OGK-HSK50/FZ31	OGK	185	R-OTR-ISO50/D25	MS	179	T1-045010		156	V0-211330-1818	216	Z1-029012-0000		204
R-OGK-HSK63/FZ19	OGK	185	R-OW-JT2/D8		219	T2-040010		153	V0-211330-2020	215	Z1-029112-0000		204
R-OGK-HSK63/FZ31	OGK	185	R-OW-JT6/D13		219	T2-040310		153	V0-211330-2020	216	Z1-031012-0000		205
R-OGK-HSK80/FZ48	OGK	185	R-RF15/J16	RF	198	T2-045010		153	V0-211330-2020	217	Z1-031115-0000		206
R-OGK-ISO30/FZ19	OGK	184	R-RF15/J17	RF	198	T2-046010		156	V0-310000-0205	214	Z1-040011-0000		203
R-OGK-ISO30/FZ31	OGK	184	R-RF23/J421	RF	198	T9-100011-0720		155	V0-310500-0306	214	Z1-085011-0000		203
R-OGK-ISO30/FZ48	OGK	184	R-RF23/J422	RF	198	T9-100012-0560		155	V0-311000-0205	214	Z2-019315-0000		207
R-OGK-ISO40/FZ19	OGK	184	R-RF32/J441	RF	198	T9-100013-0400		155	V0-311500-0306	214	Z2-024315-0000		



Все права защищены. Переиздание, частичное или полное копирование разрешаются только с согласия FANAR S.A.
Ответственность, возникшая из-за ошибок, неправильной интерпретации или опечаток исключается.
Оставляем за собой право вносить технические изменения.

Catalogue edition 18 - 1000 pcs.

The editorial team:
Dariusz Ptaszkiewicz
Paweł Czaplicki
Radosław Zdanowski
Krzysztof Stanisławczuk
Graphic design:
Krystian Stryjewski
Rafał Pankratjew

Correction and editing in Russian:
Anna Szal - „Graformik” Sp. z o.o.

Ciechanów, IX 2017 r.





Tool Factory Fanar Joint Stock Company

Płocka 11 street, 06-400 Ciechanow POLAND

tel.: (48 23) 672 44 44, fax: (48 23) 672 48 41

email: info@fanar.pl, www.fanar.eu

Export Department

tel.: (48 23) 674 30 03  

(48 23) 674 30 35 

(48 23) 672 42 62 

email: export@fanar.pl



Инструмент для резьбы

Catalogue - edition 18